

**MSCCH-01**

**VARDHMAN MAHA VEER OPEN UNIVERSITY**



**INORGANIC CHEMISTRY**

---

**Course Development Committee**

---

**Chair Person****Prof. Vinay Kumar Pathak**

Vice-Chancellor

Vardhaman Mahaveer Open University, Kota

---

**Coordinator and Members**

---

**Coordinator****Dr. Arvind Pareek**

Director (Regional Centre)

Vardhaman Mahaveer Open University, Kota

**Members: .****Dr. Anuradha Dubey**

Deputy Director

School of Science &amp; Technology

Vardhaman Mahaveer Open University, Kota

**Dr. P.S. Verma**

(Retd.), Prof. of Chemistry

University of Rajasthan jaipur

**Dr. P.D. Sharma**

(Retd.), Prof. of Chemistry

University of Rajasthan, jaipur

**Dr. R.L. Pilaliya**

(Retd.), lecturer in Chemistry

Govt. College, Bikaner

**Dr. Sanjay Kumar Sharma**

Prof. of Chemistry

JECRC,university Jaipur

**Dr. Sunil Kumar Jangir**

Asstt. Prof. Chemistry

School of Science &amp; Technology

Vardhaman Mahaveer Open University, Kota

**Dr. Pahup Singh**

(Retd.), Prof. of Chemistry

University of Rajasthan, jaipur

**Prof. Ashu Rani**

Prof. of Chemistry

University of Kota, Kota

**Dr. Sapna Sharma**

Prof. of Chemistry

JECRC,university Jaipur

**Ms. Renu Hada**

Guest Faculty Chemistry

Vardhaman Mahaveer Open University, Kota

---

**Editing and Course Writing**

---

**Editor****Dr. Sweta Nagar**

Principal MD Mission College,

Kota

<b>Name of Writers</b>	<b>Unit No.</b>	<b>Name of Writers</b>	<b>Unit No.</b>
<b>Dr. Renu Hada</b>	,7,11,19,20,21	<b>Dr. Nayma Siddiqui</b>	1
Guest faculty, VMOU, Kota		Lecturer, SGSITS, Ujjain, MP	
<b>Dr. Vishwajeet Singh Yadav</b>	3,4,5,8,10,13	<b>Rajesh Kumar Meena</b>	6,16,18
Assistant professor, Kadi Sarva		Lecturer, M.D. Mission College, Kota	
University, Gandhi Nagar, Gujrat			
<b>Dr. Sanjay Parihar</b>	9,12,14,15	<b>Ankit Sharma</b>	17
Lecturer, MITM, Ujjain, MP		Assistant professor, University of	
		Kota, Kota	

---

**Academic and Administrative Management**

---

**Prof. Vinay Kumar Pathak**

Vice-Chancellor

Vardhaman Mahaveer Open University, Kota

**Prof. Karan Singh**

Director (MP&D)

Vardhaman Mahaveer Open University, Kota

**Prof. L.R.Gurjar**

Director (Academic)

Vardhaman Mahaveer Open University, Kota

**Dr. Anil Kumar Jain**

Additional Director (MP&D)

Vardhaman Mahaveer Open University, Kota

---

**ISBN :**

All Right reserved. No part of this Book may be reproduced in any form by mimeograph or any other means without permission in writing from V.M. Open University, Kota.

Printed and Published on behalf of the Registrar, V.M. Open University, Kota.

Printed by :

**MSCCH-01  
INORGANIC CHEMISTRY**

**Name of Unit**

**Page no**

Unit - 1 : Group Theory	1-16
Unit - 2 : Molecular Symmetry and Symmetry Groups	17-43
Unit - 3 : Representations of Groups	44-67
Unit - 4 : Group Theory and Quantum Mechanics	68- 85
Unit - 5 : Molecular Orbital Theory (MOT)	86-110
Unit - 7 :Hydrogen Group	111-132
Unit - 8 : Alkali and alkaline earth metals	133-152
Unit- 9 : Organometallic compounds	153-173
Unit - 10 :Boron Group	174-217
Unit – 11 : Carbon Group	218- 236
Unit - 12 : Nitrogen Group	237-254
Unit -13 : Oxygen Group	255- 279
Unit -14 : Halogen group	280-300
Unit - 15 : Noble Gases	301-321
Unit - 16 : Transition Metal Ions	322-346
Unit-17 : Concepts and Scope of ligand field	347-372
Unit – 18 : Electronic spectra of complexes	373-396
Unit – 19 : Magnetic properties of complexes	397- 415
Unit-20 : Bioinorganic Chemistry	416- 436
Unit - 21 : Choice, uptake and assembly of metal containing units in Biology	437-463

---

# Unit - 1 : Group Theory

---

## Structure of Unit:

- 1.0 Objective
- 1.1 Introduction
- 1.2 Definition of group
- 1.3 Group Multiplication Tables
- 1.4 Subgroup
- 1.5 Classes
- 1.6 Summary
- 1.7 Review questions
- 1.8 References

---

## 1.0 Objective

---

At the end of this unit learner can able to understand

- Basic definition of group theory
- What are groups and its theorems
- What are classes?
- Basic characteristics of subclasses

---

## 1.1 Introduction

---

The experimental chemist in his daily work and thought is concerned with observing and, to as great an extent as possible, understanding and interpreting his observations on the nature of chemical compounds. Today, chemistry is a vast subject. In order to do thorough and productive experimental work, one must know so much descriptive chemistry and so much about experimental techniques that there is not time to be also a master of chemical theory. Theoretical work of profound and creative nature, which requires a vast training in mathematics and

physics, is now the particular province of specialists. And yet, if one is to do more than merely perform experiments, one must have some theoretical framework for thought. In order to formulate experiments imaginatively and interpret them correctly, an understanding of the ideas provided by theory as to the behavior of molecules and other arrays of atoms is essential. The problem in educating student chemists-and in educating ourselves is to decide what kind of theory and how much of it is desirable. In other words, to what extent can the experimentalist afford to spend time on theoretical studies and at what point should he say, "Beyond this I have not the time or the inclination to go?" The answer to this question must of course vary with the special field of experimental work and with the individual. In some areas fairly advanced theory is indispensable. In others relatively little is useful. For the most part, however, it seems fair to say that molecular quantum mechanics, that is, the theory of chemical bonding and molecular dynamics, is of general importance.

The number and kinds of energy levels that an atom or molecule may have are rigorously and precisely determined by the symmetry of the molecule or the environment of the atom. Thus, from symmetry considerations alone, we can always tell what the qualitative features of a problem must be. We shall know, without any quantitative calculations whatever, how many energy states there are and what interactions and transitions between them may occur. In other words, symmetry considerations *alone* can give us a complete and rigorous answer to the question "What is possible and what is completely impossible?" Symmetry consideration alone can not, however, tell us how likely it is that the possible things will actually take place. Symmetry can tell us that in principle two states of the system *must* differ in their energy, but only by computation or measurement can we determine how great the difference will be again symmetry can tell us that only certain absorption bands in the electronic or vibration spectrum of a molecule may occur.

By using symmetry considerations alone we may predict the number of vibrational fundamentals, their activities in the infrared and Raman spectra, and the way in which the various bonds and inter bond angles contribute to them for any molecule

possessing some symmetry. The actual magnitudes of the frequencies depend on the interatomic forces in the molecule, and these cannot be predicted from symmetry properties.

In recent years, the use of X-ray crystallography by chemists has improved enormously. No chemist is fully equipped to do research (or read the literature critically) in any field dealing with crystalline compounds, without a general idea of the symmetry conditions that govern the formation of crystalline solids.

An understanding of this approach requires only a superficial knowledge of quantum mechanics.

In a number of applications of symmetry methods, however, it would be artificial and foolishness to exclude religiously all quantitative considerations. Thus, it is natural to go a few steps beyond the procedure for determining the symmetries of the possible molecular orbitals and explain how the requisite linear combinations of atomic orbitals may be written down and how their energies may be estimated. It has also appeared desirable to introduce some quantitative ideas into the treatment of ligand field theory.

---

## 1.2 Definition of group

---

A group  $C$  is a collection of elements which satisfy the following conditions.

1. For any two elements  $a$  and  $b$  in the group the product  $a \times b$  is also an element of the group.

In order for this condition to have meaning, we must, of course, have agreed on what we mean by the terms "multiply" and "product. Perhaps we might say combination instead of product in order to avoid pointless incorrect connotations. Let us not yet force ourselves to any particular law of combination but merely say that, if  $A$  and  $B$  are two elements of a group, we point out that we are combining them by simply writing  $AB$  or  $BA$ . Now instantaneously the question arises if it makes any difference whether we write  $AB$  or  $BA$ . In ordinary algebra it does not, and we say that multiplication is commutative, that is  $xy = yx$ , or  $3 \times 6 = 6 \times 3$ . In group

theory the commutative law does not in general hold Thus  $AB$  may give  $C$  and  $BA$  may give  $D$  where  $C$  and  $D$  are two more elements in the group. There are some groups, however, in which combination is commutative such groups are called *Abelian* groups. Because of the truth that multiplication is not in general commutative, it is sometimes convenient to have a means of stating whether an element  $B$  is to be multiplied by  $A$  in the sense  $AB$  or  $BA$ . In the first case we can say that  $B$  is left-multiplied by  $A$ , and in the second case that  $B$  is right-multiplied by  $A$

2. There exists an unit element  $1$  in the group such that  $1 \times a = a \times 1 = a$  for every element  $a$  or in other words one element in a group must commute with all others and leave them unchanged. It is customary to designate this element with the letter  $E$  and it is usually called the *identity element*.
3. There must be an inverse (or reciprocal) element  $a^{-1}$  of each element  $a$  such that

$$a \times a^{-1} = a^{-1} \times a = 1.$$

or every element must have a reciprocal, which is also an element of the group. The element  $R$  is the reciprocal the element  $S$  if  $RS = SR = E$  where  $E$  is the identity. Obviously, if  $R$  is the reciprocal of  $S$ , then  $S$  is the reciprocal of  $R$ . Also,  $E$  is its own reciprocal.

At this point we shall prove a small theorem concerning reciprocals which

The associative law of multiplication must hold. This is expressed in the following way

$$A(BC) = (AB)C$$

In simple words, we may combine  $B$  with  $C$  in the order  $BC$  and then combine this product,  $S$ , with  $A$  in the order  $AS$ , or we may combine  $A$  with  $B$  in the order  $AB$ , obtaining a product, say  $R$ , which we then combine with  $C$  in the order  $RC$  and get the same final product either way. In general, of course, the associative property must hold for the continued product of any number of elements.



## Some Examples of Groups

The significance of the above defining rules, we may consider an infinite group and then some finite groups.

As an infinite group we may take all of the integers, both positive, negative, and zero. If we take as our law of combination the ordinary algebraic process of addition, then rule 1 is satisfied. Clearly, any integer may be obtained by adding two others. Note that we have an Abelian group since the order of addition is immaterial. The identity of the group is 0, since  $0 + n = n + 0 = n$ . Also, the associative law of combination holds, since, i.e.,

$$[(+3) + (-7)] + (+1043) = (+3) + [(-7) + (+1043)]$$

The reciprocal of any element,  $n$ , is  $(-n)$ , since  $(+n) + (-n) = 0$ .

---

## 1.3 Group Multiplication Tables

---

If we have a absolute and non redundant list of the elements of a finite group and we know what all of the possible products (there are  $h^2$ ) are, then the group is absolutely and uniquely defined at least in an abstract sense. The foregoing information can be presented most conveniently in the form of the group multiplication table. This consists of  $h$  rows and  $h$  columns. Each column is labeled with a group element, and so is each row. The entry in the table under a given column and along a given row is the product of the elements which head that column and that row. Because multiplication is in general not commutative, we must have an agreed upon and consistent rule for the order of multiplication. Arbitrarily, we shall take factors in the order - (column element) x (row element) thus at the intersection of the column labeled by  $X$  and the row labeled by  $Y$  we find the element, which is the product  $XY$ . We now prove an important theorem about group multiplication tables, called the *rearrangement theorem*.

### Dihedral group

The symmetry of a square is the 4-fold dihedral  $D_4$  symmetry. To understand a discrete group, we first identify how many elements are in the group which is called the order of the group  $h$ . It is obvious that any integer multiples of  $\pi/2$

rotations would leave the square invariant. There are four in equivalent rotations of this kind. A mirror inversion of the square is also an invariant transformation. Applying inversion to the previous rotations, we get another four rotations Thus, the elements of  $D_4$  group are

$$D_4 = \{I, R, R^2, R^3, P, PR, PR^2, PR^3\} \quad (1)$$

That is to say the order of the group

$$h = 8.$$

General not commutative, we must have an agreed upon and consistent rule for the order of multiplication. Thus at the intersection of the column labeled by  $X$  and the row labeled by  $Y$  we find the element, which is the product  $XY$ .

We now prove an important theorem about group multiplication tables, called the rearrangement theorem.

Each row and each column in the group multiplication table lists each of the group elements once. Form this it follows that no two rows may be identical nor may any two columns be identical. This each row and each column is a rearranged list of the group elements.

PROOF. Consider the group consist of the  $h$  elements  $E, A_2, A_3, \dots, A_h$ . The elements in a given row, say the  $n$ th row, are

$$EA_n, A_2A_n, \dots, A_nA_n, \dots, A_hA_n$$

Since no two group elements,  $A_i$  and  $A_j$  for instance are the same, no two, products,  $A_iA_n$  and  $A_jA_n$ , can be the same. The  $h$  entries in the  $n$ th row are all diverse. Since there are only  $h$  group elements, each of them must be there once and only once. The argument can obviously be adapted to the columns.

### Groups of orders 1, 2, and 3

Consider now systematically examine the possible abstract groups of low order, using their multiplication tables to define them. There is, of course, formally a group of order 1, which consists of the identity element alone. There is only one possible group of order 2 It has the following multiplication table and will be designated  $G_2$

$G_2$	$E$	$A$
$E$	$E$	$A$
$A$	$A$	$E$

For a group of order 3, the multiplication table will have to be, in part, as follows:

	$E$	$A$	$B$
$E$	$E$	$A$	$B$
$A$	$A$		
$B$	$B$		

There is then only one way to complete the table, either

$AA = B$  or  $AA = E$ . If  $AA = E$  then  $BB = E$

and we would augment the table to give

	$E$	$A$	$B$
$E$	$E$	$A$	$B$
$A$	$A$	$E$	
$B$	$E$		

But then we can get no further, since we would have to accept  $BA = A$  and  $AB = A$  in order to complete the last column and the last row, respectively, thus repeating  $A$  in both the second column and the second row. The alternative,  $AA = B$ , leads unambiguously to the following table:

$G_3$	$E$	$A$	$B$
$E$	$E$	$A$	$B$
$A$	$A$	$B$	$E$
$B$	$B$	$E$	$A$

### Cyclic Groups

If  $G_3$  is the simplest, nontrivial member of an important set of groups i.e. the cyclic Groups. We note that  $AA = B$  while  $AB (=AAA) = E$ . Thus we can believe that entire group to be generated by taking the element  $A$  and its powers,  $A^2(= B)$  and  $A_3(= E)$  In general, the cyclic group of order  $h$  is defined as an element  $X$  and all of its powers Up to  $X^h = E$ . We shall presently examine several other cyclic groups. An important property of cyclic, groups is that they are Abelian, that is all multiplications are commutative. This must be so, Since the various group elements are all of the form  $X^n, X^m$ , and so on, and, clearly  $X^n X^m, X^m X^n$ , for all  $m$  and  $n$ .

### Groups of Order 4

To carry on, we ask how many groups of order 4 there are and what their multiplication table(s) will be. Obviously, there will be a cyclic group of order 4. Let us employ the relations.

$$\begin{aligned} X &= A & X^3 &= C \\ X^2 &= B & X^4 &= E \end{aligned}$$

From this we find that the multiplication table, in the usual format, is as follows:

$G_4^{(1)}$	$E$	$A$	$B$	$C$
$E$	$E$	$A$	$B$	$C$
$A$	$A$	$B$	$C$	$E$
$B$	$B$	$C$	$E$	$A$
$C$	$C$	$E$	$A$	$B$

We note that for  $G_4^{(1)}$  only one element, namely B, is its own Inver be Suppose instead, we assume that each of two elements , A and B is its own inverse. We shall then have no choice but to also make C its own inverse, since each of the four E's in the table must lie in a different row and column, Thus, we would obtain

	<i>E</i>	<i>A</i>	<i>B</i>	<i>C</i>
<i>E</i>	<i>E</i>	<i>A</i>	<i>B</i>	<i>C</i>
<i>A</i>	<i>A</i>	<i>E</i>		
<i>B</i>	<i>B</i>		<i>E</i>	
<i>C</i>	<i>C</i>			<i>E</i>

A moment's consideration will show that there is only one way to complete this table:

$G_4^{(2)}$	<i>E</i>	<i>A</i>	<i>B</i>	<i>C</i>
<i>E</i>	<i>E</i>	<i>A</i>	<i>B</i>	<i>C</i>
<i>A</i>	<i>A</i>	<i>E</i>	<i>C</i>	<i>B</i>
<i>B</i>	<i>B</i>	<i>C</i>	<i>E</i>	<i>A</i>
<i>C</i>	<i>C</i>	<i>B</i>	<i>A</i>	<i>E</i>

It is also clear that there are no other possibilities. Thus, there are two groups of order 4, namely  $G_4^{(1)}$  and  $G_4^{(2)}$  which may be considered to be defined by their multiplication tables.

### Groups of Orders 5 and 6

Similarly, a systematic examination on the possibilities for groups of if we make up to table in which only element (other than E) is its own inverse and let that element be A or C instead of B as in the  $G_4^{(1)}$  table given, we are not inventing a different  $G_4$  we are only permuting the arbitrary symbols for the group elements.

the multiplication table for one of the groups of order 6 is given below:

$G_6^{(1)}$	<i>E</i>	<i>A</i>	<i>B</i>	<i>C</i>	<i>D</i>	<i>F</i>
<i>E</i>	<i>E</i>	<i>A</i>	<i>B</i>	<i>C</i>	<i>D</i>	<i>F</i>
<i>A</i>	<i>A</i>	<i>E</i>	<i>D</i>	<i>F</i>	<i>B</i>	<i>C</i>
<i>B</i>	<i>B</i>	<i>F</i>	<i>E</i>	<i>D</i>	<i>C</i>	<i>A</i>
<i>C</i>	<i>C</i>	<i>D</i>	<i>F</i>	<i>E</i>	<i>A</i>	<i>B</i>
<i>D</i>	<i>D</i>	<i>C</i>	<i>A</i>	<i>B</i>	<i>F</i>	<i>E</i>
<i>F</i>	<i>F</i>	<i>B</i>	<i>C</i>	<i>A</i>	<i>E</i>	<i>D</i>

---

## 1.4 Subgroup

---

Inspection of the multiplication table for the group  $G_6^{(1)}$  will show that within this group of order 6 there are smaller groups. The identity *E* in itself is a group of order 1. This will, of course, be true in any group and is trivial the groups of order 2, namely *E,A*; *B,E,C* and the group of order 3 namely *E, D, F*. The last should be known also as the cyclic group  $G_3$ , since  $D^2 F, D^3 DF = FD = E$ . But to go back to the main point smaller groups that may be found within a larger group are called subgroups. There are, of course, groups that have no Subgroups other than the trivial one of *E* itself.

Now consider, whether there are any restrictions on the nature of subgroups, restrictions that are logical consequences of the general definition of a group and not of any additional or special characteristics of a particular group. We may note that the orders of the group  $C_6^{(1)}$  and its subgroups are 6 and 1, 2, 3; in short, the orders of the subgroups are all factors of the order of the main group. We shall now prove the following theorem:

There order of any subgroup *g* of a group of order *h* must be a divisor of *h*.

In other words,  $h/g = k$  where *k* is an integer.

PROOF. Let us consider that the set of *g* elements,  $A_1, A_2 A_3 \dots, A_g$ , forms a subgroup. Now assume another element *B* in the group which is not a member of

this subgroup and form all of the  $g$  products:  $BA_1 BA_2 \dots , BA_g$ . No one of these products can be in the subgroup. If, for example,

$$BA_2 = A_4$$

then, if we take the reciprocal of  $A_2$ , perhaps  $A_5$ , and right-multiply the above equality, we obtain

$$BA_2A_5 = A_4A_5$$

$$BE = A_4A_5$$

$$B = A_4A_5$$

But this contradicts our assumption that  $B$  is not a member of the subgroup  $A_1, A_2, \dots , A_g$ , since  $A_4A_5$  can only be one of the  $A_i$ . Hence, if all the products  $BA_i$  in the large group in addition to the  $A_i$  themselves, there are at least  $2g$  members of the group. If  $h > 2g$ , we can choose still another element of the group, namely  $C$ , which is neither one of the  $A_i$  nor one of the  $BA_i$  and on multiplying the  $A_i$  by  $C$  we will obtain  $g$  more elements, all members of the main group, but none members of the  $A_i$  or of the  $BA_i$  sets.

Thus we now know that  $h$  must be at least equal to  $3g$ . However, we must reach the point where there are no more elements by which we can multiply the  $A_i$  that are not among the sets  $A_i, BA_i, CA_i$ , and so forth, already obtained. Suppose after having found  $k$  such elements, we reach the point where there are no more. Then  $h = kg$ , where  $K$  is an integer, and  $h/g = k$ , which is what we set out to prove.

Even though we have shown that the order of any subgroup,  $g$ , must be a divisor of  $h$ , we have not proved the converse, namely, that there are subgroups of all orders that are divisors of  $h$ , and, indeed, this is not in general true.

Furthermore, as our illustrative group proves, there can be more than one subgroup of a given order.

## 1.5 Classes

We have studied that in a given group it may be possible to select various smaller sets of elements, each such set including  $E$ , however, which are in themselves

groups. There is another method in which the elements of a group may be separated into smaller sets, and such sets are called *classes*. Before defining a class we must consider an operation known as *similarity transformation*.

If  $A$  and  $X$  are two elements of a group, then  $X^{-1}AX$  will be equal to some elements of the group, say  $B$ . We have

$$B = X^{-1}AX$$

We express this relation in words by saying that  $B$  is the *similarity transform* of  $A$  by  $X$ . We also say that  $A$  and  $B$  are conjugate. The following properties of conjugate elements are important.

(i) Every element is conjugate with itself. This means that if we choose any particular element  $A$  it must be possible find at least one element  $X$  such that

$$A = X^{-1}AX$$

If we left-multiply by  $A^{-1}$  we obtain

$$A^{-1}A = E = A^{-1}X^{-1}AX = (XA)^{-1}(AX)$$

Which can hold only if  $A$  and  $X$  commute. Thus the element  $X$  may always be  $E$ , and it may be any other element that commutes with the chosen element,  $A$ .

(ii) If  $A$  is conjugate with  $B$ , then  $B$  is conjugate with  $A$ . This means that if

$$A = X^{-1}BX$$

then there must be some element  $Y$  in the group such that

$$B = Y^{-1}AY$$

That this must be so is easily proved by carrying out appropriate multiplications, namely,

$$XAX^{-1} = XX^{-1}BXX^{-1} = B$$

Thus, if  $Y = X^{-1}$  (and thus also  $Y^{-1} = X$ ), we have

$$B = Y^{-1}AY$$

and this must be possible, since any element, say  $X$ , must have an inverse, say  $Y$ .



(iii) If A is conjugate with B and C, then B and C are conjugate with each other. The proof of this is easy to work out from the foregoing discussion and is left as an exercise.

We are now able to define a class of group. A complete set of elements that are conjugate to one another is called a class of the group.

In order to calculate the classes within any particular group we can begin with one element and work out all of its transforms, using all the elements in the group, including itself, then take a second element, which is not one of those found to be conjugate to the first, and determine all its transforms, and so on until all elements in the group have been placed in one class or another.

Let us illustrate this procedure with the group  $G_6$ . All of the results given below may be verified by using the multiplication table. Let us start with E.

$$E^{-1}EE = EEE = E$$

$$A^{-1}EA = A^{-1}AE = E$$

$$B^{-1}EB = B^{-1}BE = E$$

Thus E must constitute by itself a class, of order 1, since it is not conjugate with any other element. This will, of course, be true in any group. To continue,

$$E^{-1}AE = A$$

$$A^{-1}AA = A$$

$$B^{-1}AB = C$$

$$C^{-1}AC = B$$

$$D^{-1}AD = B$$

$$F^{-1}AF = C$$

Thus the elements A, B, and C are all conjugate and are therefore members of the same class. Continuing we have

$$E^{-1}DE = D$$

$$A^{-1}DA = F$$

$$B^{-1}DB = F$$

$$C^{-1}DC = F$$

$$D^{-1}DD = D$$

$$F^{-1}DF = D$$

It will also be found that every transform of F is either D or F. Hence, D and F constitute a class of order 2.

It will be noted that the classes have orders 1, 2, and 3, which are all factors of the group order, 6. It can be proved, by a method similar to that used in connection with the orders of subgroups, that the following theorem is true:

The orders of all classes must be integral factors of the order of the group.

---

## 1.6 Summary

---

After reading this unit learner become familiar with essential terms of group theory. The unit is summarized as -The experimental chemist in his daily work and thought is concerned with observing and, to as great an extent as possible, understanding and interpreting his observations on the nature of chemical compounds. Today, chemistry is a vast subject. In order to do through and productive experimental work, one must know so much descriptive chemistry and so much about experimental techniques that there is not time to be also a master of chemical theory. Theoretical work of profound and creative nature, which requires a vast training in mathematics and physics, is now the particular province of specialists. And yet, if one is to do more than merely perform experiments, one must have some theoretical framework for thought. In order to formulate experiments imaginatively and interpret them correctly, an understanding of the ideas provided by theory as to the behavior of molecules and other arrays of atoms is essential. The problem in educating student chemists-and in educating ourselves is to decide what kind of theory and how much of it is desirable. In other words, to what extent can the experimentalist afford to spend time on theoretical studies and at what point should he say, "Beyond this I have not the time or the inclination to

go?" The, answer to this question must of course vary with the special field of experimental work and with the individual. In some areas fairly advanced theory is indispensable. In others relatively little is useful. For the most part, however, it seems fair to say that molecular quantum mechanics, that is, the theory of chemical bonding and molecular dynamics, is of general importance.

A **group** is a collection of elements which satisfy the some conditions.

If we have a absolute and non redundant list of the elements of a finite group and we know what all of the possible products (there are  $h^2$ ) are, then the group is absolutely and uniquely defined at least in an abstract sense. The foregoing information can be presented most conveniently in the form of the **group multiplication table**.

The main point smaller groups that may be found within a larger group are called **subgroups**.

We have studied that in a given group it may be possible to select various smaller sets of elements, each such set including E, however, which are in themselves groups. There is another method in which the elements of a group may be separated into smaller sets, and such sets are called **classes**.

---

## 1.7 Review Questions

---

1. Prove that in any Abelian group, each element is in a class by itself.
2. Show that there can be only one group of order  $h$ , when  $h$  is a prime number.
3. Write down the multiplication table for the cyclic group of order 5. Show by trial and error that no other one is possible.
4. Why can we not have a group in which  $A^2 = B^2 \neq E$ ?
5. If we start with the multiplication table for group  $G_3$  and add another element,  $C$ , which commutes with both  $A$  and  $B$ , what multiplication table do we end up with?

6. Show that for any cyclic group,  $X, X^2, X^3, \dots, X^h(=E)$ , there must be one subgroup corresponding to each integral divisor of the order  $h$ . Give an example.
7. Invent as many different noncyclic groups of order 8 as you can and give the multiplication table for each .
8. For each of the groups of order 8, show how it breaks down into subgroups and classes.
9. Derive the multiplication table for all other groups of order 6 besides the one shown in the text. This will require you to show that a group of order 6 in which every element is its own inverse is impossible.
10. For the groups  $G_4^{(1)}, G_4^{(2)}$  and the cyclic group of order 6, show what classes and subgroups each one has .

---

## 1.8 References

---

1. Group Theory and its Chemical Applications - P.K. Bhattacharya (Himalaya Publishing House) 2003
2. Physical Methods in Inorganic Chemistry – Russell S. Drago (East-West PVT. LTD. ) 1971
3. Advanced inorganic chemistry: A comprehensive text- F. Albert Cotton and Geoferey Wilkinson (3 Ed) Interscience Publisher, 1972

---

# Unit - 2 : Molecular Symmetry and Symmetry Groups

---

## Structure of Unit:

- 2.0 Objectives
- 2.1 Introduction
- 2.2 Symmetry Elements and Symmetry Operations
- 2.3 Product of Symmetry Operations
- 2.4 Equivalent Symmetry Elements and Atoms
- 2.5 Symmetry Elements and Optical Isomerism
- 2.6 Classes of Symmetry Operations
- 2.7 Symmetry Point Groups and their Classification
- 2.8 Summary
- 2.9 Review Question
- 2.10 Reference and Suggested readings

---

## 2.0 Objectives

---

At the end of the unit learner will be able to

- Understand the symmetry elements and symmetry operations generated by them
- Understand that how symmetry elements co-related with optical isomerism
- Determination of point groups

---

## 2.1 Introduction

---

In a nonmathematical sense the concept of symmetry is associated with regularity or proportionality. In short it is associated with beauty. Consider an example of

sign of exclamation. Now we rotate this sign seven times, through an angle of  $45^\circ$  about an axis passing through the centre of the dot and perpendicular to the plane of the paper. The symmetry operation (rotation) about the symmetry element (axis) gives a beautiful flower in which each petal of flower is related to one another by rotation through  $45^\circ$  about the symmetry axis.

In dealing with molecules, which are present in various conformations, we try to identify the symmetry elements and symmetry operations that will tell us that how the atoms in the molecules are related to one another in space. To do this we should know the kinds of symmetry elements and operations generated by them.

---

## 2.2 Symmetry Elements and Symmetry Operations

---

Although symmetry operations and symmetry elements are related to each other but are two different things. Symmetry element is a geometrical entity such as line plane or a point with respect to which one or more symmetry operations may be carried out.

A symmetry operation is the actual movement of atoms in a molecule such that after the operation has been carried out every atom is coincident with an equivalent atom. In other words after the operation has been carried out on a molecule we get an equivalent or identical configuration.

In other words if we note the position and orientation of the body before and after a movement is carried out, that movement is a symmetry operation, if these two orientations are indistinguishable.

Types of Symmetry Element: There are four types of symmetry elements-

- a) Proper axis of symmetry (C)
- b) Plane of symmetry ( $\sigma$ )
- c) Improper axis of symmetry (S)
- d) Centre of inversion (i)

One or more symmetry operations are associated with one symmetry element. Some authors have included identity as a symmetry element, but it is a symmetry operation.

The four kinds of symmetry elements and operations generated by them required to specify molecular symmetry-

S. No.	Symmetry Elements	Symmetry Operations
1	Proper axis of symmetry	One or more rotation about the axis
2	Plane of symmetry	Reflection in plane
3	Improper axis of symmetry	One or more repetitions of the sequence: rotation followed by reflection in a plane perpendicular to the rotation axis.
4	Centre of inversion	Inversion of all atoms through centre

**a) Proper axis of symmetry:**

It is an imaginary axis around which the rotation carried out on the molecule, which takes the molecule from one orientation to the other equivalent indistinguishable orientation. The proper axis of symmetry is represented by  $C_n$ . And the operations generated by this are represented by  $C_n^m$ .

Where  $n$  = order of the axis

$m$  = no. of times the operation is carried out

The order of axis is defined as the number of times an operation is to be carried out so as to get an identical configuration.

$$n = \frac{2\pi}{\theta}$$

$\theta$  = angle by which rotation is carried out

Let us consider the example of  $\text{H}_2\text{O}$  molecule.

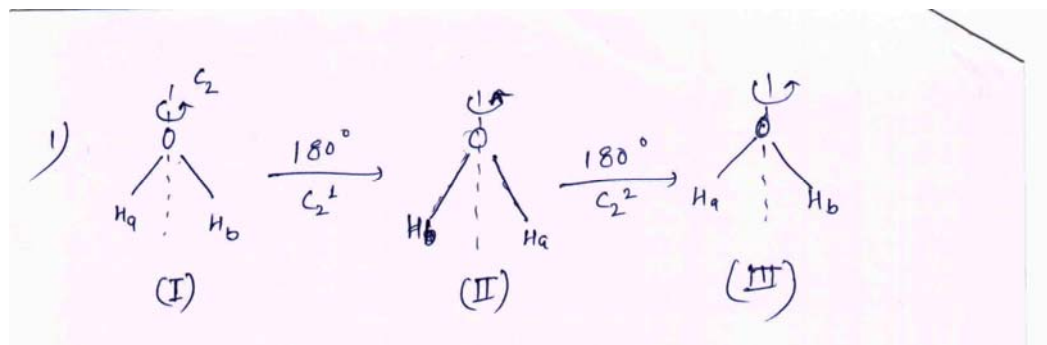

We observe that rotation by  $180^\circ$  about the axis takes molecule I into II. Since the two hydrogen atoms are indistinguishable. This rotation is a symmetry operation, however we note that two atoms have been interchanged (since we have labeled them as  $\text{H}_a$  &  $\text{H}_b$ ) and hence the configuration II is not exactly same as I or identical to I but it is equivalent to I. If we rotate it once more we get the configuration III, which is exactly the same as I or identical to I.

Here rotation is carried out by  $180^\circ$ , so according to the formula:

$$n = \frac{2\pi}{\theta}$$

$$n = \frac{360}{180} = 2$$

So order of axis is 2, and axis of symmetry is represented by  $\text{C}_2$ . As it is clear from the above figure that after rotating water molecule 2 times by  $180^\circ$  we are getting an identical configuration.

Consider another example of boron trifluoride ( $\text{BF}_3$ ). Now the rotation by  $120^\circ$  in anticlockwise direction about an axis passing through boron atom and perpendicular to plane of the paper brings the molecule from configuration I to II, which is equivalent to I. One more rotation converts it from II to III. It is seen that the configuration I and IV are identical and to get an identical configuration of  $\text{BF}_3$  molecule, the operations was carried out three times about the symmetry axis.



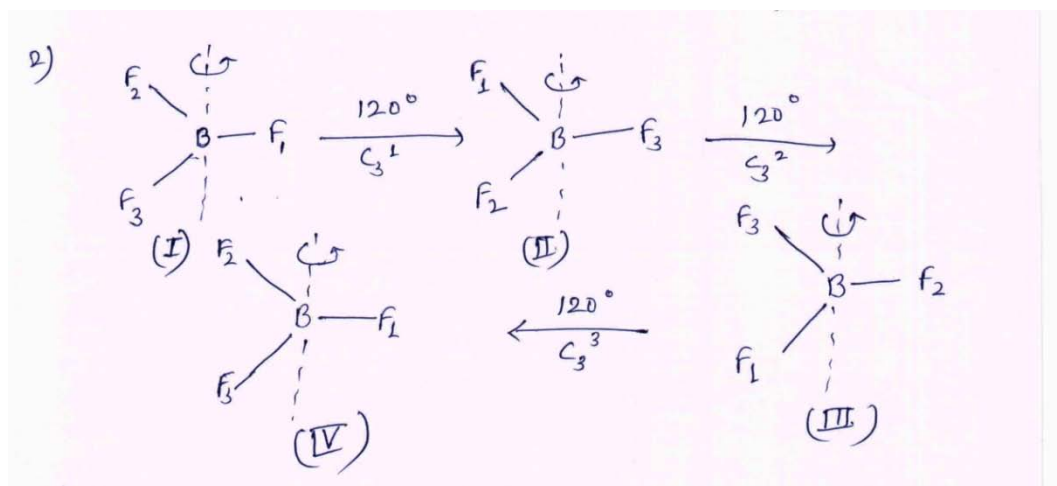

As the rotation is carried out by  $120^\circ$ , so order of axis is-

$$n = \frac{360}{120} = 3$$

So order of axis is 3 and axis is represented by  $C_3$ . The  $C_3$  axis thus generated 3 operations  $C_3^1$ ,  $C_3^2$  and  $C_3^3$ . The operation  $C_3^4$  will result in configuration I, which is equivalent to  $C_3^1$ . The  $C_3^3$  results in identical configuration & we can write

$$C_3^3 = E$$

Where E represents identity

In general we can write

$$C_n^m = E \quad (\text{When } n=m)$$

$$C_n^{m+1} = C_n^1$$

$$C_n^{m+2} = C_n^2 \quad \& \text{ so on....}$$

A molecule can have more than one axis of symmetry. As in the last example suppose the rotation is being carried through each B-F bond by  $180^\circ$ . So  $BF_3$  molecule contains three  $C_2$  axis ( $C_2$ ,  $C_2'$  and  $C_2''$ ) along with  $C_3$  axis.

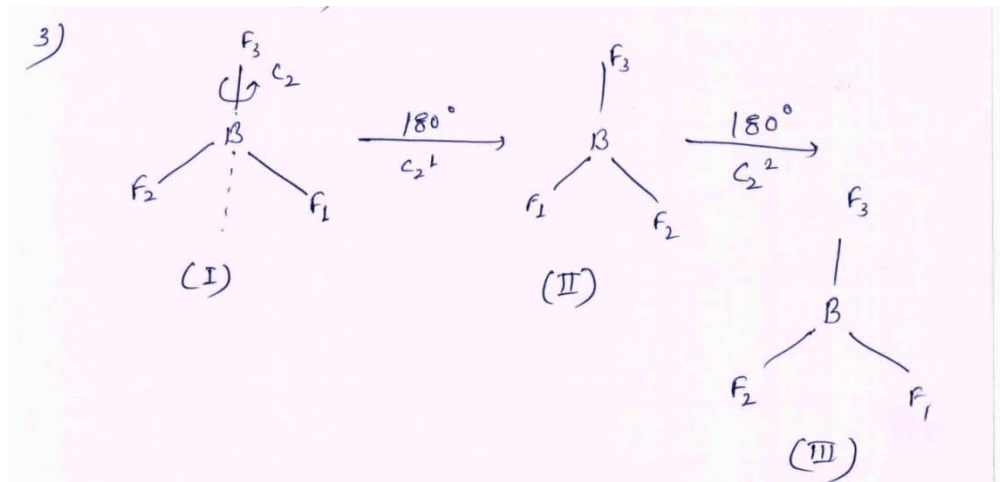

If there are several proper axis of rotation then the axis of highest order symmetry is called the principal axis and the lowest order symmetry is known as subsidiary axis. If the molecule has more than one axis of highest order, then the one that passes through maximum number of atom is the principal axis. In  $\text{BF}_3$  molecule  $C_3$  axis is principal axis.

#### b) Plane of Symmetry

It is an imaginary plane within the molecule which bisects it into two equal half which are mirror image s of each other. A plane of symmetry exists when a reflection through the plane gives an equivalent configuration. Plane of symmetry is represented by  $\sigma$ .

Let us consider the example of water molecule. There exists a plane of symmetry for this molecule which contains oxygen atom and bisect the angle HOH as shown in figure.

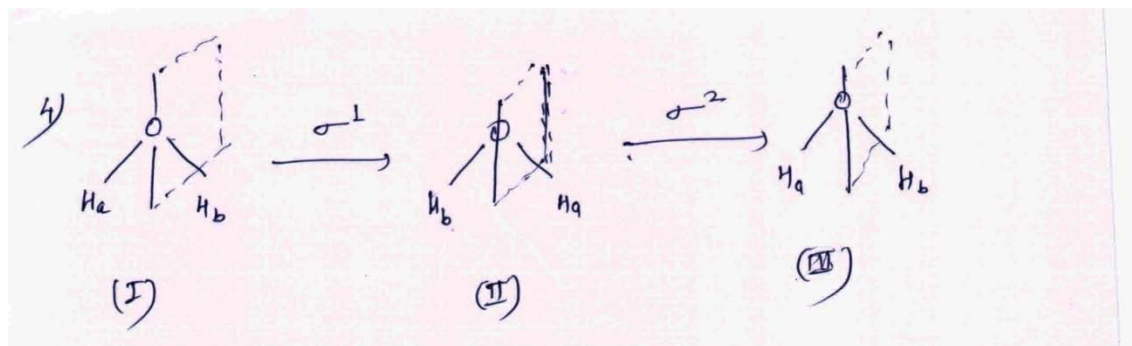

We can see that the configuration II is equivalent to I as the reflection through the plane results in the exchange of the two hydrogen atoms. The atom of oxygen which lies in the plane is not shifted. We get an identical configuration III after carrying out one more operation of reflection.

From the above example we also find that carrying out the operation of reflection twice results in an identical configuration. When the operation carried out one more time, we get the configuration II.

In general we write

$$\sigma^n = E \quad \{\text{When } n \text{ is even}\}$$

$$\sigma^n = \sigma \quad \{\text{When } n \text{ is odd}\}$$

Types of plane of symmetry: the plane of symmetry can be divided into three types-

- 1) Vertical plane of symmetry ( $\sigma_v$ ) - The plane passing through the principal axis and one of the subsidiary axis (If present) is called vertical plane of symmetry.
- 2) Horizontal plane of symmetry ( $\sigma_h$ ) - The plane perpendicular to the axis is called horizontal plane of symmetry.
- 3) Dihedral plane of symmetry ( $\sigma_d$ ) - The plane passing through principal axis but passing in between two subsidiary axes is called dihedral plane.

Water molecule has 2 planes of symmetry one in passing through O and in between 2 H atoms that is in yz plane

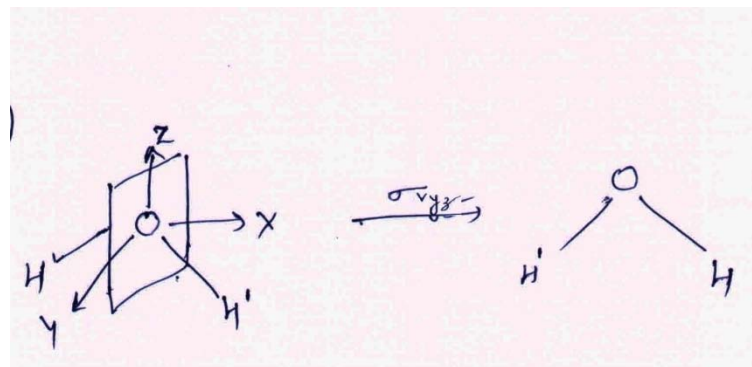

As this plane passes through  $C_2$  axis which is principal axis in case of  $H_2O$  molecule so this plane is a vertical plane and it is represented as  $\sigma_{v_{yz}}$ . The other is the molecular plane passing through O and 2 H atoms in XZ plane. This plane also passes through  $C_2$  axis so it is called as  $\sigma_{v_{xz}}$ .

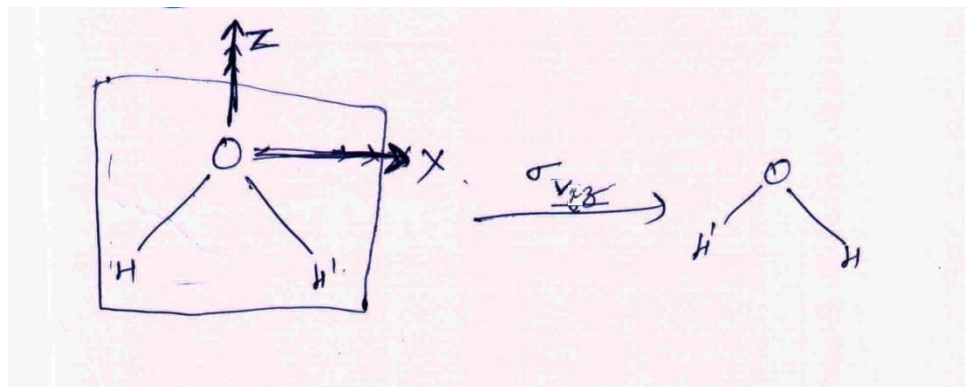

The ammonia molecule has three  $\sigma_v$ , each passing through N atom and one of the H atoms and bisects the H-N-H angle. The  $BF_3$  molecule, with trigonal planar geometry has a  $C_3$  axis and has four planes of symmetry. Out of these four planes three planes passing through  $C_3$  axis and one of the  $C_2$  axis, can be represented as  $\sigma_v$ . The molecule has also a plane of symmetry which is perpendicular to  $C_3$  axis represented as  $\sigma_h$ .

Consider the example of 2,6- dichloro benzophenone.

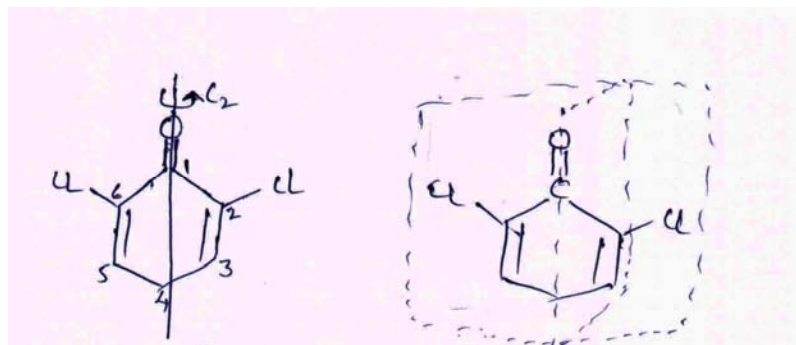

As shown in figure the molecule possesses  $C_2$  axis and it is the only axis of symmetry so it is principal axis. The two planes of symmetry the molecular plane and the plane containing the oxygen atom and bisects the angle between the carbon

atom 2, 1 and 6 containing the principal axis and hence are vertical planes of symmetry  $\sigma_v$ . So in this molecule horizontal plane of symmetry is absent.

There is one more kind of plane of symmetry  $\sigma_d$ , The dihedral plane of symmetry. These are the planes which bisect the angle between two adjacent subsidiary axes. The molecule of allene as shown in figure has two dihedral planes of symmetry.

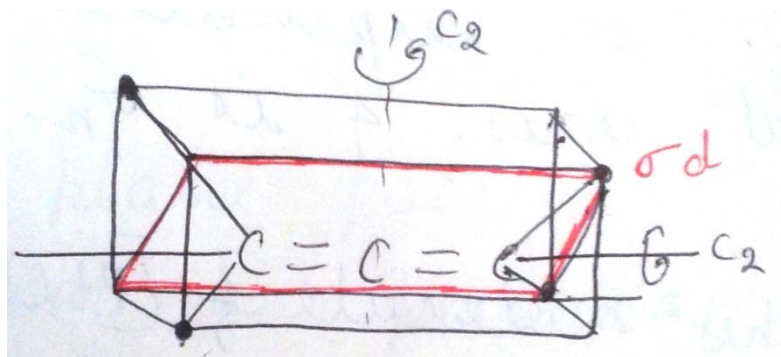

### c) Improper Axis of Symmetry

An improper axis of rotation is said to exist when rotation about an axis followed by a reflection in a plane perpendicular to the axis of rotation results in an equivalent or identical configuration or in other words we can say that it is an imaginary axis on which the molecule has to be rotated and then reflected on a plane perpendicular to the rotation axis to get an equivalent or identical configuration.

The improper axis of rotation is represented by  $S_n$ . The operations generated by it are represented by  $S_n^m$ , where

$n$  = order of axis and

$m$  = no. of times the operation is being performed.

This symmetry element can be best understood by considering the following example of trans dichloro ethene. Carrying out a  $C_2$  operation about an axis passing through the  $C=C$  bond gives configuration II which is then followed by reflection in a plane perpendicular to axis of rotation gives configuration IV which is equivalent to I. We perform the same operations but this time in reverse manner. First we reflect the molecule in a plane described above. This results in

configuration III which after rotation about the axis along the C=C and again gives configuration IV. These combined operations are shown in figure.

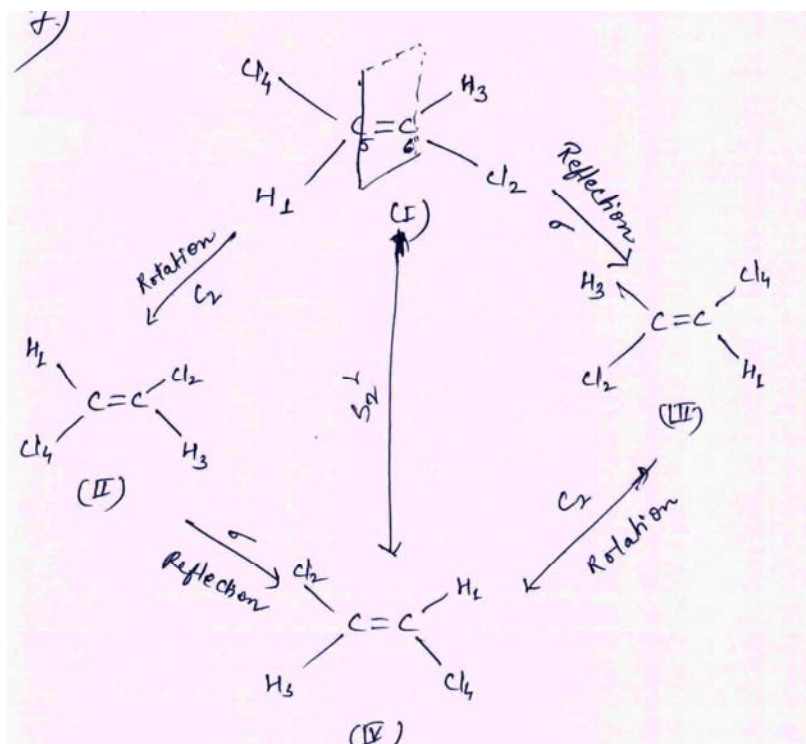

From the above figure it is concluded that “whether we perform  $C_2$  operation first than the  $\sigma$  or we perform  $\sigma$  first and then  $C_2$  operation, the result is same.

$$\sigma \cdot C_2 = C_2 \cdot \sigma$$

So either rotation followed by reflection or reflection followed by rotation will give the same results. The order of operation is important the operation is always carried out from right to left as indicated by arrow. On comparing II and III with I, we find that neither II nor III is equivalent to I and hence neither  $C_2$  nor  $\sigma$  is a symmetry operation but configuration IV is equivalent to I and hence the combination of  $C_2$  and  $\sigma$  is a symmetry operation. Thus the improper axis in the above example of trans dichloro ethylene is represented by  $S_2$ . The  $BF_3$  molecule

has  $C_3$  axis and the molecular plane lying perpendicular to it makes the improper axis to exist automatically. The improper axis is co-linear with  $C_3$  axis. Thus the improper axis in  $BF_3$  is represented as  $S_3$ .

The element  $S_n^m$  generates a set of operations  $S_n^1 S_n^2 S_n^3 \dots$  but whether  $S_n^m = E$  or not, depends upon on  $n$  being even or odd. We shall now discuss these 2 cases.

Let us consider the operations generated by  $S_n$  axis with  $n$  even say  $S_4$ . It should be mentioned that an element of symmetry is said to generate as many operations as necessary to get an identical configuration. Now we write the operations generated by  $S_4$  in the following way.

$$\begin{aligned} S_4^1 &= C_4^1 \cdot \sigma^1 = S_4^1 \\ S_4^2 &= C_4^2 \cdot \sigma^2 = C_2^1 \cdot E = C_2^1 \quad \{\text{because } \sigma^2 = E \text{ and } C_4^2 = C_2^1\} \\ S_4^3 &= C_4^3 \cdot \sigma^3 = S_4^3 \\ S_4^4 &= C_4^4 \cdot \sigma^4 = E \end{aligned}$$

Thus the operations generated by  $S_4$  axis have  $S_4^1$ ,  $C_2^1$ ,  $S_4^3$  and  $E$ . In these operations we have  $C_2$  and  $E$  which are the operations generated by a  $C_2$  axis. This means that we have a  $C_2$  axis co-linear with the  $S_4$  axis.

Let us now consider  $S_n$  axis with  $n$  odd say an  $S_3$  axis, and the operations generated by this axis are as follows:

$$\begin{aligned} S_3^1 &= C_3^1 \cdot \sigma^1 = S_3^1 \\ S_3^2 &= C_3^2 \cdot \sigma^2 = C_3^2 \cdot E = C_3^2 \\ S_3^3 &= C_3^3 \cdot \sigma^3 = E \cdot \sigma = \sigma \quad \{\text{because } \sigma^3 = \sigma\} \\ S_3^4 &= C_3^4 \cdot \sigma^4 = C_3^4 \cdot E = C_3^1 \quad \{\text{because } C_n^{m+1} = C_n^1 \text{ and } \sigma^4 = E\} \\ S_3^5 &= C_3^5 \cdot \sigma^5 = S_3^5 \\ S_3^6 &= C_3^6 \cdot \sigma^6 = C_3^3 \cdot E = E \cdot E = E \quad \{\text{because } C_n^{m+3} = C_n^3\} \end{aligned}$$

Thus an  $S_3$  axis has generated  $S_3^1$ ,  $C_3^1$ ,  $C_3^2$ ,  $S_3^5$ ,  $\sigma$  and  $E$  operations.

From the above examples we note that-

- An  $S_3$  axis has generated six operations and in general an  $S_n$  axis with  $n$  odd will generate  $2n$  operations.

- An  $S_4$  axis has generated 4 operations so in general an  $S_n$  axis with  $n$  even will generate  $n$  operations.

#### d) Centre of inversion

A molecule is said to possess a centre of symmetry if reflection of each atom through centre of the molecule results in its coincidence with an equivalent atom. We define it as for every atom at  $x, y, z$  here exist an identical atom at  $-x, -y, -z$ . It means that if any atom in the molecule is connected with the centre of symmetry, equivalent atom lies on the opposite side. This is best illustrated by the following example:

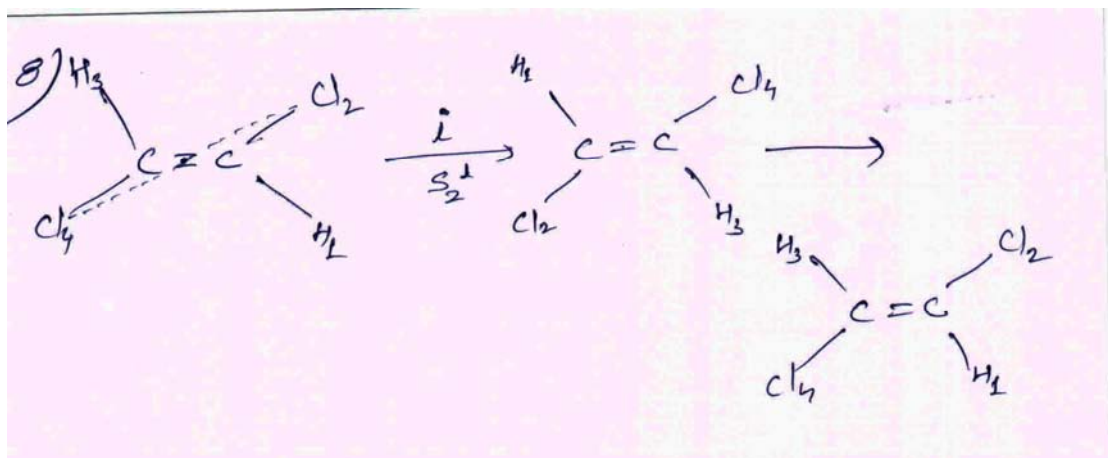

The centre of inversion is represented by  $i$  and the operations generated by this is expressed by  $i^n$ . It can be seen that

$$i^n = E \quad \{ \text{if } n = \text{even} \}$$

$$i^n = i \quad \{ \text{if } n = \text{odd} \}$$

Unlike plane of symmetry, the centre of inversion generates only one operation. The configuration generated by  $S_2$  axis is equivalent to that generated by a centre of inversion and hence an  $S_2$  axis is always represented by  $i$ . Other examples of molecule having centre of inversion are  $\text{CO}_2$ ,  $\text{C}_2\text{H}_4$ ,  $\text{N}_2\text{O}_2$ ,  $[\text{Co}(\text{NH}_3)_6]^{3+}$  etc.

#### Identity

This is an operation which brings back the molecule to the original orientation. It is represented by  $E$ . There are several different types of operations which bring back



the molecule to its original orientation, they are not considered separately but are put together as identity. For example an axis of four folds symmetry  $C_4^1$ ,  $C_4^2$  and  $C_4^3$  are considered as rotation operations. But  $C_4^4$  that is rotation by  $360^\circ$  is not considered as a rotational operation because it is an identity operation. Over a plane of symmetry only one reflection operation is considered. If the reflection is repeated, the original orientation is obtained and hence the second reflection is an identity operation. Thus the identity operation in effect means doing nothing on the molecule and hence does not seem to be of much importance lies in considering the molecules as a group and to apply the group theory to molecules.

### Exercise-

Qu. 1 How many symmetry elements are present in benzene molecule.

Qu. 2 How many symmetry elements are present in ammonia molecule.

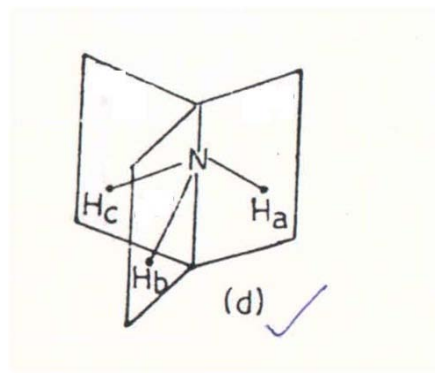

---

## 2.3 Product of Symmetry Operations

---

When we say that we are multiplying 2 symmetry operations we mean that we are combining the two operations and the resulting combination of the two operations is the product of the multiplication. When we write the multiplication and the product in the following way-

$$yx=z$$

we mean that operation x is carried out first and then operation y, giving the same net effect as would the carrying out of the single operation z.

Here it should be noted that the order in which the operations are applied is the order in which they are written from right to left. When the results of the sequence xy

is the same as the result of the sequence  $yx$ , the two operations  $x$  and  $y$  are said to commute.

Let us consider the product of the two mutually perpendicular axes say  $C_2(x)$  and  $C_2(y)$ . This can be best illustrated by the following example. Consider the example of  $C_2H_4$  molecule with the three  $C_2$  axes marked as shown below. First  $C_2(x)$  operation is carried out followed by  $C_2(y)$ , which gives configuration III.

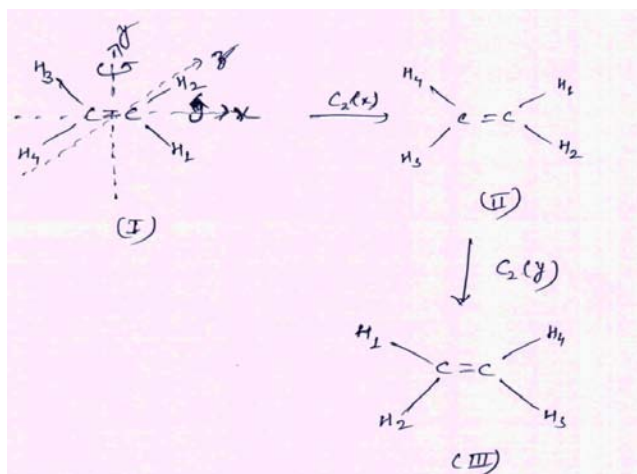

It can be seen that configuration III can be obtained by carrying out  $C_2(z)$  operation.

Thus we can write-

$$C_2(y).C_2(x)=C_2(z)$$

Similarly we carry out operation  $C_2(y)$  first followed by  $C_2(x)$

Here also configuration III can be obtained by carrying out  $C_2(z)$  operation. Thus we can write;

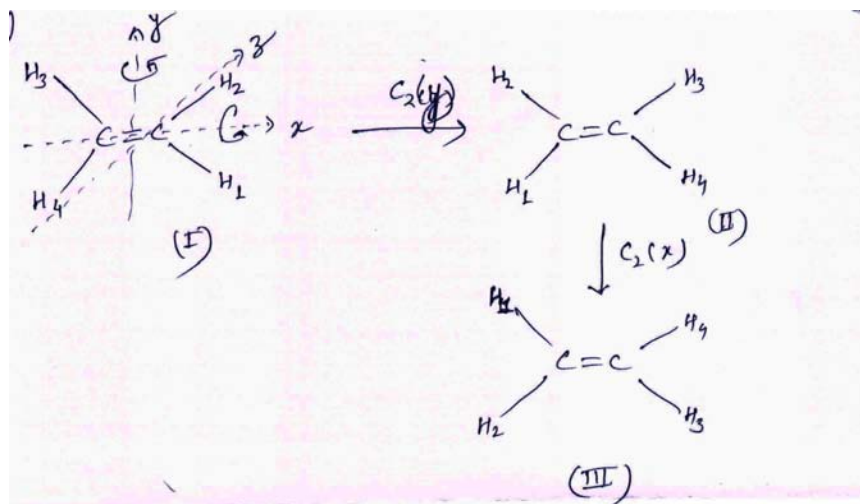

$$C_2(x). C_2(y) = C_2(z)$$

Thus the two operations  $C_2(x)$  and  $C_2(y)$  are commute. It can be shown that the following pairs of operations commute.

- 1) Reflection through planes perpendicular to each other
- 2) The inversion and any reflection or rotation
- 3) Two rotations about the same axis
- 4) Rotation and reflection in a plane perpendicular to it

## 2.4 Equivalent Symmetry Elements and Atoms

Any set of symmetry element chosen so that any member can be transformed into each and every other member of the set by some operation is said to be a set of equivalent symmetry elements. The above statement will become clear from the following example.

Consider an example of square planar  $AB_4$  molecule. This molecule has a  $C_4$  axis and four  $C_2$  axes as marked in the figure. Let us carry out  $C_4^1$  operation and we note that  $C_2$  is taken into  $C_2''$  and  $C_2''$  into  $C_2$  and  $C_2'$  is taken into  $C_2'''$  and  $C_2'''$  into  $C_2'$ . We further carry out the  $C_4$  operation and note that  $C_2$  is taken into itself and  $C_2''$  is taken into itself similarly  $C_2'$  is taken into itself and  $C_2'''$  into itself. But there is no way of taking  $C_2$  into  $C_2'$  and  $C_2''$  into  $C_2'''$ .

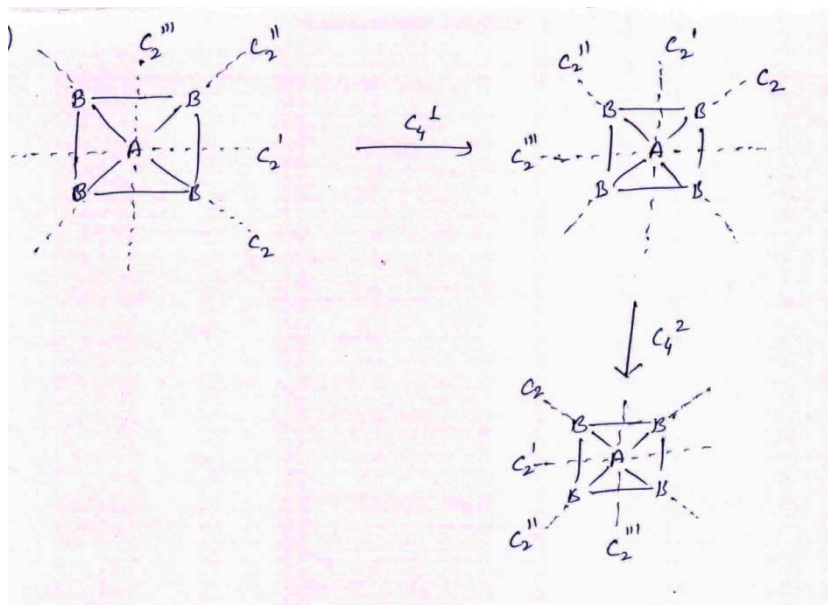

Thus the set of  $C_2$  axis namely  $C_2$  and  $C_2''$  and  $C_2'$  and  $C_2'''$  are equivalent.

Other examples of equivalence or non equivalence of symmetry elements are  $BF_3$ ,  $NH_3$  and  $H_2O$  molecules. We note that all the three of the symmetry planes in  $BF_3$ , which are perpendicular to the molecular plane are equivalent as are in the  $NH_3$  whereas the 2 planes in  $H_2O$  molecules are non equivalent. The six two fold axis lying in the plane of benzene molecule can be divided into two sets of equivalent axis one set containing those which transect opposite carbon atoms and other sets containing those which bisect the opposite edge of the hexagon.

Equivalent atoms in a molecule are those which may all be interchanged with one another by symmetry operations. The best example to understand the equivalent atoms is  $PCl_5$  molecule. This molecule has a  $C_3$  axis collinear with the axial chlorine atoms and three  $C_2$  axes in the equatorial planes. It is possible to take the equatorial chlorine atoms into one another by the  $C_3$  operations and two axial chlorine atoms can be taken into one another by the  $C_2$  operations but there is no way to interchange the two axial chlorine atoms by equatorial chlorine atoms.

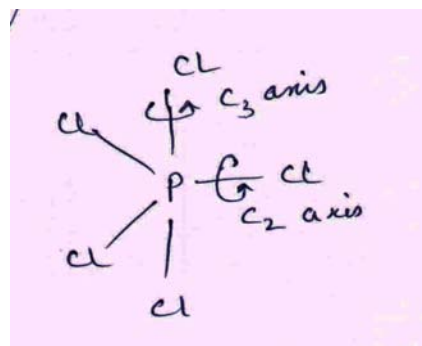

Examples of equivalent atoms include all of the hydrogen atoms in methane, ethane, benzene or cyclopropane and all carbon & oxygen atoms in  $Cr(CO)_6$ . All six carbon atoms of cyclohexane are equivalent in the chair conformation but four are different from the other two in the boat conformation.

---

## 2.5 Symmetry Elements and Optical Isomerism

---

As we have discussed all the symmetry elements in previous section. Now in this section we will see that how symmetry elements are correlated with optical isomerism. Optical isomers or enantiomers are the molecules which cannot be superimposed on its mirror image and such molecules are said to be chiral and are optically active. The word chiral is a Greek word which means “hand”. So the property of handedness is known as chirality. Human hands are chiral because both the hands are mirror image of each other but are non superimposable. So the enantiomers occur only with those compounds whose molecules are chiral. Consider the example of 2-butanol, which is a chiral molecule. The enantiomers of 2-butanol are drawn in the three dimensional projection formula. Figure shows that the mirror image of 2-butanol isomer is **non-superimposable** upon the original molecule.

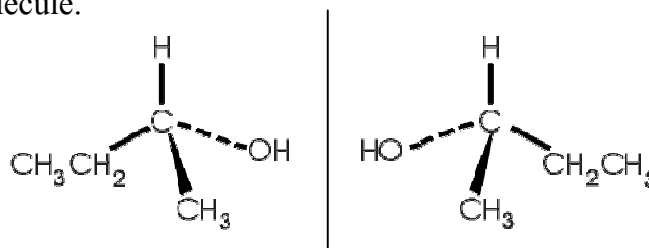

Thus the compounds of the type Cabcd exist in enantiomeric form and are described as chiral and the carbon with different atoms or groups as substituents is called a stereogenic centre or simple stereocentre. Molecules which are superimposable on its mirror image are known as achiral molecules. An imaginary plane that bisects a molecule in such a way that the two halves of the molecule are mirror images of each other then plane of symmetry exists. A molecule with a plane of symmetry cannot be chiral. Such molecules are achiral.

An alternative approach to decide if or not a structure is chiral that is in enantiomeric form (optically active) is to determine the symmetry of a molecule.

When the molecule has a centre of symmetry (C<sub>i</sub>) or a plane of symmetry (σ) or n-

fold alternating axis of symmetry ( $S_n$ ), the mirror images of the molecules are superimposable and the molecule is achiral (optically inactive).

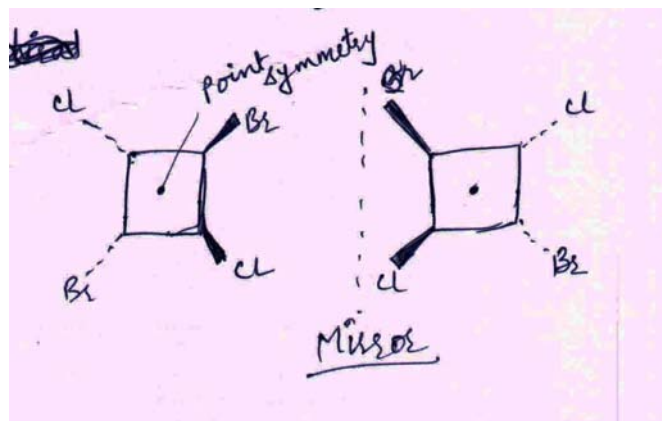
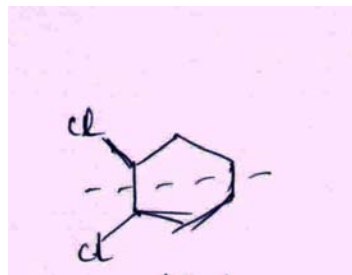

It is not a necessary condition for chirality that a molecule should have no symmetry elements. A chiral compound may have axis of rotation ( $C_n$ ).

Tartaric acid may be taken as another example to study its chirality in terms of symmetry elements. This acid exists as a pair of enantiomers (I and II). Both the enantiomers are diastereomeric with meso form (optically inactive).

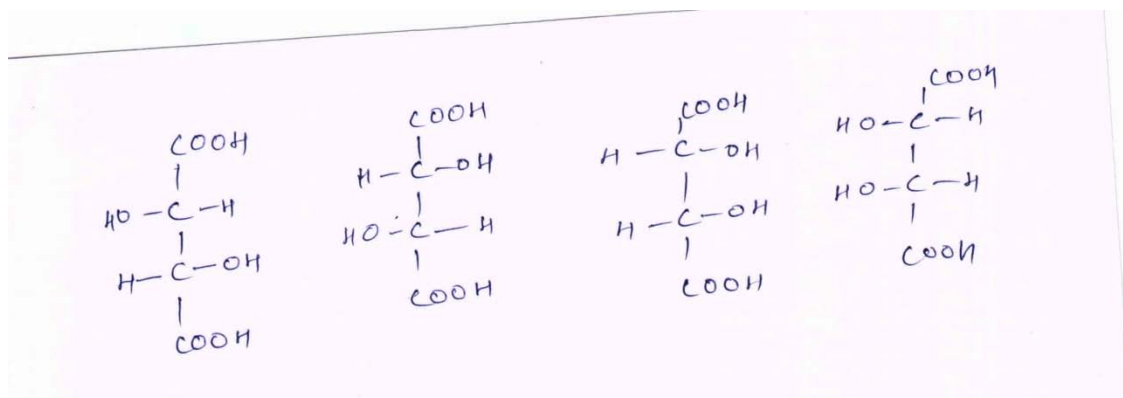

*Meso*- tartaric acid is achiral even though it has two stereocentre since it has a plane of symmetry.

Qu.1 How many equivalent atoms present in  $SF_6$  molecule.

Qu.2 Define mesocompounds.

---

## 2.6 Classes of Symmetry Operations

---

Before studying classes of symmetry operations we must read about the groups. A set of elements is said to form a group when the elements of the set are related to one another by some rules. For any set of elements to form a group the following four conditions must be satisfied:

- 1) The product of any two elements and the square of each element must be a member of the set. For example if A and B are two elements of a set and we are multiplying them by simply writing  $A \times B$  or  $B \times A$ . The products of the elements are C and D respectively. These C and D must be a member of set. In group theory the cumulative law does not hold generally, since both the products are different. So order of multiplications is important. However there are certain groups for which the products are cumulative, such groups are known as *Abelian* group.
- 2) One element in the set must commute with all other elements and leave them unchanged. In the group of A, B and C, if C is such element, then

$$AC=CA=A$$

$$BC=CB=B$$

This element is called identity E.

- 3) The associative law of multiplication must hold, this is expressed in the following equation:

$$A(BC)=(AB)C$$

In general the associative property must be hold for any number of elements-  
 $(AB)(CD)(EF)(GH)=A(BC)(DE)(FG)H=(AB)C(DE)(FG)H$

- 4) Every element must have a reciprocal which is also an element of the group. The element R is the reciprocal of the element S if  $RS=SR=E$ , where E= identity obviously. If R is reciprocal of S then S is the reciprocal of R and also E is its own reciprocal.

If we have a set of elements and we know all the possible products then the group is completely and uniquely defined. This information can be presented

in the form of a table called the multiplication table. For example in case of H<sub>2</sub>O molecule, the operations generated by it are E, C<sub>2</sub>, σ<sub>v<sub>xz</sub></sub> and σ<sub>v<sub>yz</sub></sub>.

	E	C <sub>2</sub>	σ <sub>v<sub>xz</sub></sub>	σ <sub>v<sub>yz</sub></sub>
E	E	C <sub>2</sub>	σ <sub>v<sub>xz</sub></sub>	σ <sub>v<sub>yz</sub></sub>
C <sub>2</sub>	C <sub>2</sub>	E	σ <sub>v<sub>yz</sub></sub>	σ <sub>v<sub>xz</sub></sub>
σ <sub>v<sub>xz</sub></sub>	σ <sub>v<sub>xz</sub></sub>	σ <sub>v<sub>yz</sub></sub>	E	C <sub>2</sub>
σ <sub>v<sub>yz</sub></sub>	σ <sub>v<sub>yz</sub></sub>	σ <sub>v<sub>xz</sub></sub>	C <sub>2</sub>	E

Once we have the multiplication table we then try to see whether such a set of operations forms a group or not that is we test the applicability of the rules that define the group.

The first requirement for mathematical groups that the product of two elements and square of each element must be a member of set is satisfied

$$C_2 \times C_2 = E \text{ (Which is a member of set)}$$

$$\sigma_{v_{xz}} \times \sigma_{v_{yz}} = C_2 \text{ (Which is also a member of set)}$$

All the symmetry operations of the H<sub>2</sub>O molecule are commutable hence it is abelian group.

$$C_2 \times \sigma_{v_{xz}} = \sigma_{v_{xz}} \times C_2 = \sigma_{v_{yz}}$$

The presence of identity E as a member of set satisfied second condition. The associative law is also valid for the product of symmetry operations.

$$E (C_2 \cdot \sigma_{v_{xz}}) = (E \cdot C_2) \sigma_{v_{xz}}$$

$$E \cdot \sigma_{v_{yz}} = C_2 \cdot \sigma_{v_{xz}}$$

$$\sigma_{v_{yz}} = \sigma_{v_{yz}}$$

Finally every element has an inverse here the inverse of an operation is that operation which will undo what the operation does that is the product of an operation and its inverse must be equal to identity.

$$C_2 \cdot C_2 = E$$

$$\sigma_{v_{xz}} \cdot \sigma_{v_{xz}} = E$$



$$\sigma_{yz} \cdot \sigma_{yz} \begin{array}{c|cccccc} & E & A & B & C & D & F \\ \hline & & & & & & \end{array} = E$$

Thus each operation is its own reciprocal.

In the main set of elements there exists a combination of elements which also forms a group, this group of smaller order within the main group are called subgroups. There is another way in which the elements of a group may be grouped/separated into smaller sets-, such sets of elements are called as **classes**. However for this we must know an operation called similarity transformation.

If an element A is related to element B as

$$X^{-1} A X = B$$

Where A, B and X are the elements of a set, then we say that B is the similarity transform of A by X. We can also say that elements A and B are conjugate with each other. The following properties of conjugate elements are important.

- 1) Every element is conjugate with itself
- 2) If A is conjugate with B, then B is conjugate with A
- 3) If A is conjugate with B and C then B and C must be conjugate with each other

A complete set of elements which are conjugate to each other is called as class of the group.

Let us consider the set of elements (E, A, B, C, D and F) given in the following multiplication table.

E	E	A	B	C	D	F
A	A	B	E	F	C	D
B	B	E	A	D	F	C
C	C	D	F	E	A	B
D	D	F	C	B	E	A
F	F	C	D	A	B	E

Now conjugate pair is found out by similarity transformation.

$$E^{-1} E E = E$$

$$A^{-1} E A = BA = E$$

$$B^{-1} E B = AB = E$$

$$C^{-1} E C = CC = E$$

$$D^{-1} E D = DD = E$$

$$F^{-1} E F = FF = E$$

Thus E is conjugate with itself and form a class of order one.

$$E^{-1} A E = EA = A$$

$$A^{-1} A A = AA = A$$

$$B^{-1} A B = AB = A$$

$$C^{-1} A C = CF = B$$

$$D^{-1} A D = DC = B$$

$$F^{-1} A F = FD = B$$

Hence A and B are conjugate and form a class of order two.

$$E^{-1} C E = EC = C$$

$$A^{-1} C A = BD = F$$

$$B^{-1} C B = AF = D$$

$$C^{-1} C C = CE = C$$

$$D^{-1} C D = DA = F$$

$$F^{-1} C F = FB = D$$

Here C is conjugate with D and F and hence D is conjugate with F according to rule 3. So C, D and F form a class of order three, we note that the order of a class is a division of order of main group.

One more example of water molecule is illustrated here. In this molecule all the operations are self conjugate.

$$\sigma_{v_{xz}}^{-1} \cdot C_2 \cdot \sigma_{v_{xz}} = C_2$$

$$C_2^{-1} \cdot \sigma_{v_{xz}} \cdot C_2 = \sigma_{v_x}$$

Thus each element belongs to one class.

## 2.7 Symmetry Point Groups and their Classification

We have seen that a complete set of operations do constitute a group. In this section we shall see that different kinds of groups will be obtained by collecting various symmetry operations. These symmetry groups are called point groups. When symmetry operations are performed on a molecule the physical properties do not change. The centre of symmetry of the molecule remains unshifted during symmetry operations. This is because all symmetry operations pass through centre of symmetry, hence the molecular group is known as point groups. The symbols that are used for symmetry groups are called Schoenflies symbols after their inventor.

### Classification of point groups

Point groups are classified as follows:

- 1) **Non-axial point groups:** A point group which does not have any proper axis of rotation is known as non-axial point groups. A molecule which has only identity (E) and no other operation is possible belongs to  $C_1$  point group. When a plane of symmetry is present it generates a group of order two means only two symmetry operations are possible that is,  $\sigma$  and E. Such molecules belong to  $C_s$  point group. Similarly another group of order two is formed when a molecule has inversion centre, (i and E) this group is represented by  $C_i$ . it should be remembered that molecule having i is equal to  $S_2$ , hence a molecule with only  $S_2$  belongs to point group  $C_i$ .
- 2) **Axial point groups:** when the molecules have proper or improper axis of rotation. Let us consider molecules where the proper axis is the only symmetry element present. It belongs to the point group  $C_n$ . When a molecule has a  $C_n$  axis with a vertical plane as the elements of symmetry then the molecule is said to belong the point group  $C_{nv}$ . If the molecule has a  $C_n$  axis with  $\sigma_h$  instead of  $\sigma_v$  then the point group is  $C_{nh}$ . If one or more

$C_2$  axis is present perpendicular to  $C_n$  axis (principal axis) then such molecule belongs to  $D_n$  point group. If in a molecule a  $\sigma_h$  or  $\sigma_d$  is present in addition to  $C_2$  perpendicular to  $C_n$  then it belongs to  $D_{nh}$  or  $D_{nd}$  respectively. Molecule with  $S_n$  axis form a group called  $S_n$ .

### 3) Special point groups:

a) **Linear molecules:** linear molecules have axis of infinite fold of symmetry  $C_\infty$ . It can be of two types. One is symmetrical linear molecule in which  $C_2$  axis perpendicular to  $C_\infty$  is present so it is classified as  $D_{\infty h}$  point group. Example  $CO_2$  molecule

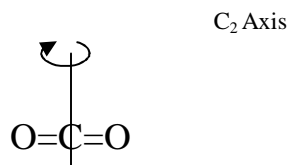

Other is unsymmetrical linear molecule like HCN that has no equivalent halves belonging to point group  $C_\infty$ .

b) **Cubic molecules:** Molecules with cubic symmetry have two types of point groups. One is tetrahedral point group ( $T_d$ ). The structure has four trigonal faces, four corners and six edges. The most common example of molecule having tetrahedral geometry is  $CH_4$ . The molecule has 24 symmetry operations. Molecules having tetrahedral geometry but do not possess all the 24 operations do not belong to  $T_d$  point group ( $CH_3Cl$ ,  $CHCl_3$ ). Other is octahedral point group ( $O_h$ ). The structure has eight trigonal faces, six corners and twelve edges.

c)

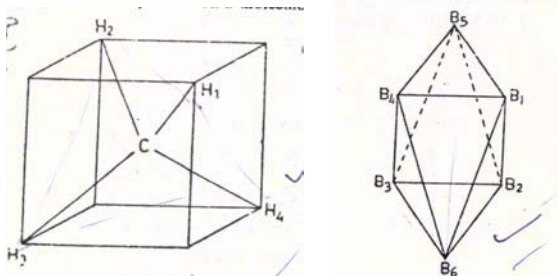

Tetrahedral geometry

Octahedral geometry

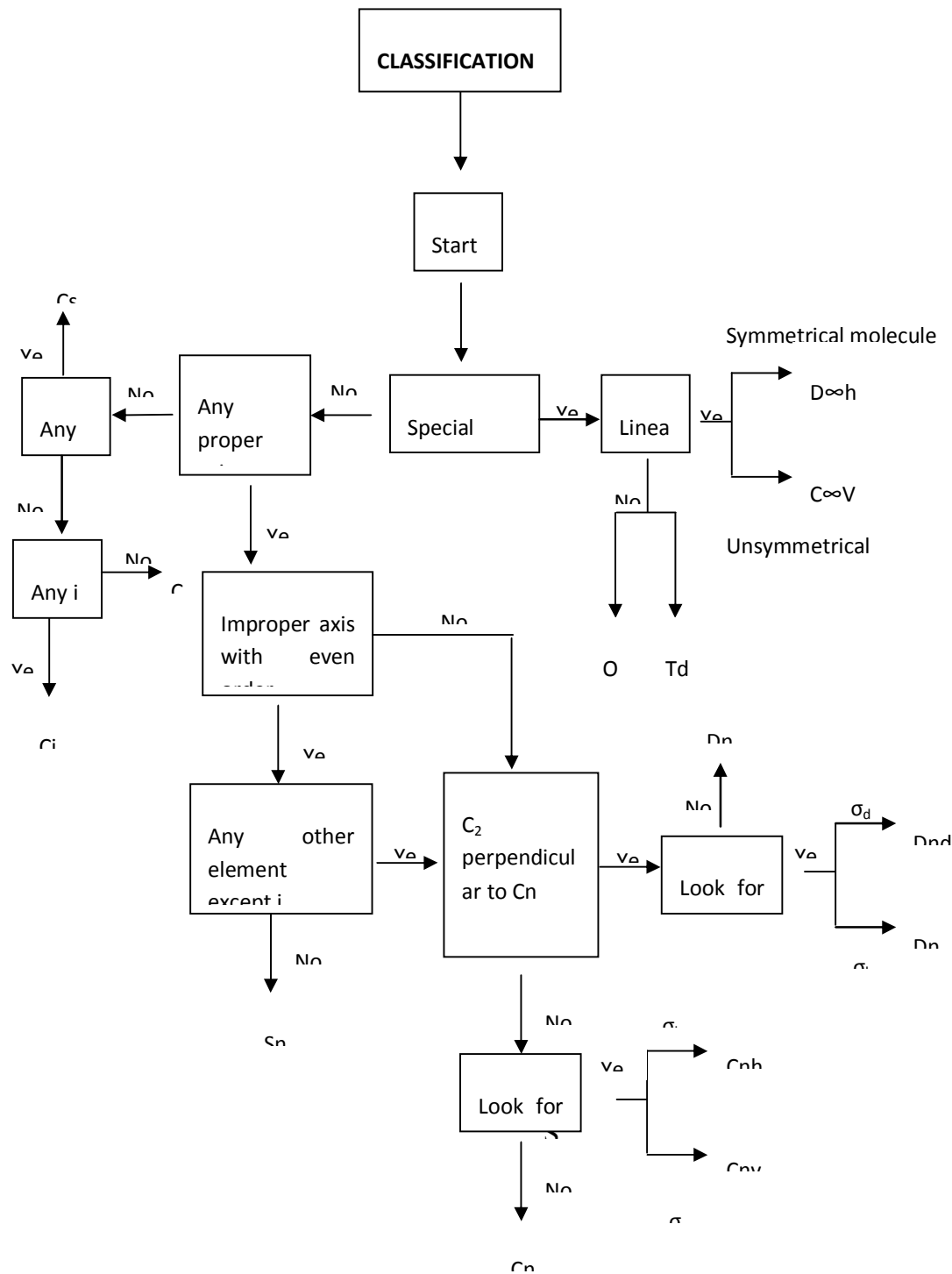

cheme 1. Classification of point groups

The following steps will lead to a correct classification:

- 1) Identify whether the molecule belongs to any special class that is if the molecule is linear it can be assigned either  $D_{\infty h}$  (symmetrical) or  $C_{\infty v}$  (unsymmetrical) point group. If the molecule is cubic it belongs Oh or Td point group.
- 2) If the molecule does not belong to special class then look for proper axis of rotation. If molecule has no proper axis of rotation then see whether it has centre of symmetry or plane of symmetry. If element  $i$  is present then it belongs to  $C_i$  and if  $\sigma$  is present then it belongs to  $C_s$ . If none of them is present then  $C_1$  point group is assigned to the molecule.
- 3) If an even order improper axis is present and no plane and proper axis of rotation is found. Except it is collinear with principal axis. Then the point group is  $S_n$ .
- 4) If the molecule has only  $C_n$  axis it belongs to point group  $C_n$ , otherwise go to steps according to scheme 1.

---

## 2.8 Summary

---

Symmetry means beauty. As the beauty of a person can be judged by his or her personality, hairs, eyes etc. which are the elements of beauty. Similarly the beauty of a molecule is determined by some elements. This chapter deals with the different symmetry elements present in molecule and the operations generated by them. With the help of symmetry elements present in molecules and symmetry operations generated by them we can determine how the atoms in the molecules are related to one another in space. The point groups of different molecule can also be determined easily with the help of symmetry elements.

---

## 2.9 Review Question

---

- 1 Determine the point groups in following compounds.  
A)  $H_2O$  B)  $PCl_5$  C) Ammonia D) ethylene molecule E)  $HOCl$
- 2 Determine the symmetry elements in  $BF_3$  molecule .
- 3 How many plane of symmetry present in  $[PtCl_4]^{2-}$ .

- 4 What is abelian group. Explain with an example.
- 5 Among the following molecules, which one is optically active and which is not:

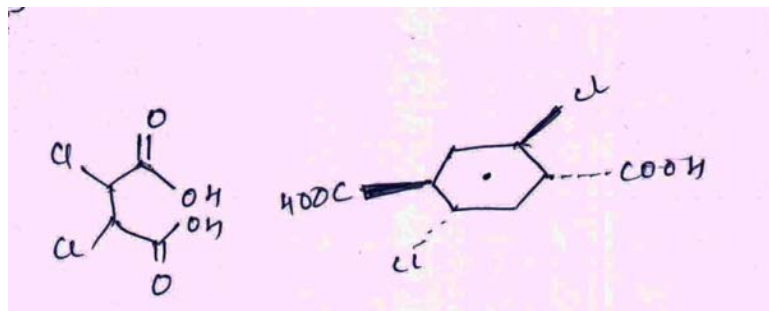

(A)

(B)

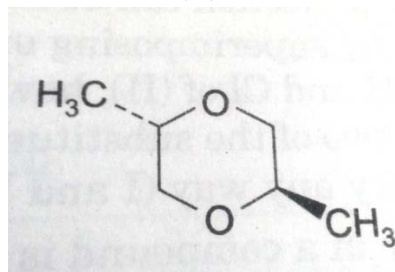

(C)

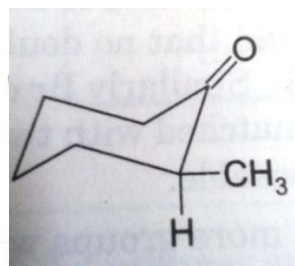

(D)

---

## 11.12 Reference and Suggested readings

---

4. Group Theory and its Chemical Applications - P.K. Bhattacharya (Himalaya Publishing House) 2003
5. Physical Methods in Inorganic Chemistry – Russell S. Drago (East-West PVT. LTD. ) 1971

---

## Unit - 3 : Representations of Groups

---

### Structure of unit

- 3.1 Objective
- 3.2 Introduction
- 3.3 Symmetry operations
- 3.4 Representation of group
- 3.5 The Great Orthogonality Theorem
- 3.6 Character Table
- 3.7 Some examples of character tables
- 3.8 Summary
- 3.9 Review Questions
- 3.10 Glossary
- 3.11 References and Suggested Readings

---

### 3.1 Objective

---

This chapter deals with the symmetry operations, representations of groups, the great orthogonality theorem, character tables. One can understand this topics after reading this chapter.

---

### 3.2 Introduction

---

Some object are "more symmetrical" than others. A sphere is more symmetrical than a cube because it looks the same after rotation through any angle about the diameter. A cube looks the same only if it is rotated through certain angels about specific axes, such as  $90^\circ$ ,  $180^\circ$ , or  $270^\circ$  about an axis passing through the centers of any of its opposite faces, or by  $120^\circ$  or  $240^\circ$  about an axis passing through any of the opposite corners. Here are also examples of different molecules which remain the same after certain symmetry operations:  $\text{NH}_3$ ,  $\text{H}_2\text{O}$ ,  $\text{C}_6\text{H}_6$ ,  $\text{CBrClF}$ . In general, an action which leaves the object looking the same after a transformation is called



a symmetry operation. Typical symmetry operations include rotations, reflections, and inversions. There is a corresponding symmetry element for each symmetry operation, which is the point, line, or plane with respect to which the symmetry operation is performed. For instance, a rotation is carried out around an axis, a reflection is carried out in a plane, while an inversion is carried out in a point.

---

### 3.3 Symmetry operations

---

The classification of objects according to symmetry elements corresponding to operations that leave at least one common point unchanged gives rise to the point groups. These are five kinds of symmetry operations and five kinds of symmetry elements of this kind. These symmetry operations are as follows.

- The identity,  $E$ , consists of doing nothing: the corresponding symmetry element is an entire object. In general, any object undergo this symmetry operation. The example of the molecule which has only the identity symmetry operation is  $C_3H_6O_3$ , DNA, and  $CHClBrF$ .
- The  $n$ -fold rotation about an  $n$ -fold axis of symmetry,  $C_n$  is a rotation through the angle  $360^\circ/n$ . Particularly, the operation  $C_1$  is a rotation through  $360^\circ$  which is equivalent to the identity  $E$ .  $H_2O$  molecule has one twofold axis,  $C_2$ .  $NH_3$  molecule has one threefold axis,  $C_3$  which is associated with two symmetry operations:  $120^\circ$  rotation  $C_3$  and  $240^\circ$  (or  $-120^\circ$ ) rotation  $C_2$ .  $C_6H_6$  molecule has one sixfold axis  $C_6$  and six twofold axes  $C_2$ . If a molecule possess several rotational axes, then the one of them with the greatest value of  $n$  is called the principal axis. All linear molecules including all diatomics has  $C_\infty$  axis because rotation on any angle remains the molecule the same.
- The reflection in a mirror plane,  $\sigma$  may contain the principal axis of a molecule, or be perpendicular to it. If the plane contains the principal axis, it is called vertical and denoted  $\sigma_v$ . For instance,  $H_2O$  molecule has

two vertical planes of symmetry and  $\text{NH}_3$  molecule has three. A vertical mirror plane which bisects the angle between two  $C_2$  axes is called a dihedral plane and is denoted by  $\sigma_d$ . If the plane of symmetry is perpendicular to the principal axis, it is called horizontal and denoted  $\sigma_h$ . For instance,  $\text{C}_6\text{H}_6$  molecule has a  $C_6$  principal axis and a horizontal mirror plane.

- The inversion through the center of symmetry is the operation which transforms all coordinates of the object according to the rule:  $(x, y, z) \rightarrow (-x, -y, -z)$ . For instance, a sphere, or a cube has a center of inversion, but  $\text{H}_2\text{O}$ , and  $\text{NH}_3$  have not.  $\text{C}_6\text{H}_6$  molecule has a center of inversion.
- The  $n$ -fold improper rotation about an  $n$ -fold axis of symmetry,  $S_n$  is a combination of two successive transformations. The first transformation is a rotation through  $360^\circ/n$  and the second transformation is a reflection through a plane perpendicular to the axis of the rotation. Note that neither operation alone needs to be a symmetry operation. For instance,  $\text{CH}_4$  molecule has three  $S_4$  axes.

---

### 3.4 Representation of group

---

representation of a group of the type we shall be interested in may be defined as a set of matrices, each corresponding to a single operation in the group, that can be combined among themselves in a manner parallel to the way in which the group elements—in this case, the symmetry operations combine. Thus, if two symmetry operations in a symmetry group, say  $C_2$  and  $\sigma$ , combine to give a product  $C_2'$ , then the matrices corresponding to  $C_2$  and  $\sigma$  must multiply together to give the matrix corresponding to  $C_2'$ . But we have already seen that, if the matrices corresponding to all of the operations have been correctly written down, they will naturally have this property.

As an example, let us work out a representation of the group  $C_2$ , which group consists of the operations  $E$ ,  $C_2$ ,  $\sigma_v$ ,  $\sigma_v'$ , a. Let us say that the  $C_2$  axis coincides with the  $z$  axis of a Cartesian coordinate system, and let  $\sigma_v$  be the  $xz$  plane and  $\sigma_v'$  be the  $yz$  plane. The matrices representing the transformations effected on a general point can easily be seen to be as follows:

$$E: \begin{bmatrix} 1 & 0 & 0 \\ 0 & 1 & 0 \\ 0 & 0 & 1 \end{bmatrix} \qquad C_2: \begin{bmatrix} -1 & 0 & 0 \\ 0 & -1 & 0 \\ 0 & 0 & 1 \end{bmatrix}$$

$$\sigma_v: \begin{bmatrix} 1 & 0 & 0 \\ 0 & -1 & 0 \\ 0 & 0 & 1 \end{bmatrix} \qquad \sigma_v': \begin{bmatrix} -1 & 0 & 0 \\ 0 & 1 & 0 \\ 0 & 0 & 1 \end{bmatrix}$$

now the group multiplication table is:

	$E$	$C_2$	$\sigma_v$	$\sigma_v'$
$E$	$E$	$C_2$	$\sigma_v$	$\sigma_v'$
$C_2$	$C_2$	$E$	$\sigma_v'$	$\sigma_v$
$\sigma_v$	$\sigma_v$	$\sigma_v'$	$E$	$C_2$
$\sigma_v'$	$\sigma_v'$	$\sigma_v$	$C_2$	$E$

It can easily be shown that the matrices multiply together in the same fashion. For example,

$$\sigma_v C_2 = \sigma_v'$$

$$\begin{bmatrix} 1 & 0 & 0 \\ 0 & -1 & 0 \end{bmatrix} \begin{bmatrix} -1 & 0 & 0 \\ 0 & -1 & 0 \end{bmatrix} = \begin{bmatrix} -1 & 0 & 0 \\ 0 & 1 & 0 \end{bmatrix}$$

Again, each element in the group  $C_2$  is its own inverse, so the same must be true of the matrices. This is easily shown to be so; for example,

$$\begin{bmatrix} \mathbf{1} & \mathbf{0} & \mathbf{0} \\ \mathbf{0} & -\mathbf{1} & \mathbf{0} \end{bmatrix} \begin{bmatrix} \mathbf{1} & \mathbf{0} & \mathbf{0} \\ \mathbf{0} & -\mathbf{1} & \mathbf{0} \end{bmatrix} = \begin{bmatrix} \mathbf{1} & \mathbf{0} & \mathbf{0} \\ \mathbf{0} & \mathbf{1} & \mathbf{0} \end{bmatrix}$$

A question that naturally arises at this point is: How many representations can be found for any particular group, say  $C_{2v}$ , to continue with that as an example? The answer is: A very large number, limited only by our ingenuity in devising ways to generate them. There are first some very simple ones, obtained by assigning 1 or -1 to each operation, namely,

$E$	$C_2$	$\sigma_v$	$\sigma_v'$
1	1	1	-1
1	-1	1	1
1	-1	-1	-1
1	1	-1	1

Then there are many representations of high order. For example, if we were to assign three small unit vectors directed along the  $x$ ,  $y$ , and  $z$  axes to each of the atoms in  $H_2O$  and write down matrices representing the changes and interchanges of these upon applying the operations, a set of four  $9 \times 9$  matrices constituting a representation of the group would be obtained. Using  $CH_2Cl_2$  in the same way, we could obtain a representation consisting of  $15 \times 15$  matrices. However, for any group only a limited number of representation are of fundamental significance and we shall now discuss the origin and properties of these.

Suppose that we have a set of matrices,  $E, A, B, C, \dots$ , which form a representation of group. If we make the same similarity transformation on each matrix, we obtain a new set of matrices, namely,

$$E' = D^{-1} E D$$

$$A' = D^{-1} A D$$

$$B' = D^{-1} B D$$

....

It is easy to prove that the new set of matrices is also a representation of the group. Suppose that

$$AB = D$$

then

$$\begin{aligned} A^1 B^1 &= (2^{-1} A 2)(2^{-1} B 2) = 2^{-1} A (2 2^{-1}) B 2 \\ &= 2^{-1} (AB) 2 = 2^{-1} D 2 = D \end{aligned}$$

Clearly, all products in the set of matrices  $E^1, A^1, B^1$  will run parallel to those in the representation  $E, A, B$  hence the primed set also constitutes a representation.

Let us now suppose that, when the matrix  $A$  is transformed to  $A^1$  using  $D$  or some other matrix, we find  $A^1$  to be a block-factored matrix, namely,

$$A^1 = D^{-1} A D = \begin{array}{c} \boxed{A'_1} \\ \boxed{A'_2} \\ \boxed{A'_3} \\ \boxed{A'_4} \\ \boxed{A'_5} \end{array}$$

for example. If now each of the matrices  $A^1, B^1, E^1$ , and so forth is blocked out in the same way, then corresponding blocks of each matrix can be multiplied together separately. Thus we can write such equation as:

$$\begin{aligned} A'_1 B'_1 &= D'_1 \\ A'_2 B'_2 &= D'_2 \\ A'_4 B'_4 &= D'_4 \end{aligned}$$

Therefore the various sets of matrices

$$\begin{aligned} E^1, A^1, B^1, D^1, \dots \\ E^2, A^2, B^2, D^2, \dots \end{aligned}$$

are in themselves representations of the group. We then call the set of matrices,  $E, A, B, E, D, \dots$ , a reducible representation, because it is possible using some matrix,  $D$  in this case, to transform each matrix in the set into a new one so that all of the new ones can be taken apart in the same way to give two or more representations of smaller dimension. If it is not possible to find a similarity transformation which will reduce all of the matrices of a given representation in the above manner, the representation is said to be irreducible. It is the irreducible representations of a group that are of fundamental importance, and their main properties will now be described.

---

### 3.5 The Great Orthogonality Theorem

---

All of the properties of group representations and their characters, which are important in dealing with problems in valence theory and molecular dynamics, can be derived from one basic theorem concerning the elements of the matrices which constitute the irreducible representations of a group. In order to state this theorem, which we shall do without proof, some notation must be introduced. The order of a group will, as before, be denoted by  $h$ . The dimension of the  $i$ th representation, which is the order of each of the matrices which constitute it, will be denoted by  $l_i$ . The various operations in the group will be given the generic symbol  $R$ . The element in the  $m$ th row and the  $n$ th column of the matrix corresponding to an operation  $R$  in the  $i$ th irreducible representation will be denoted  $\Gamma(R)_{mn}$ . Finally, it is necessary to take the complex conjugate (denoted by  $*$ ) of one factor on the left-hand side whenever imaginary or complex numbers are involved.

The great orthogonality theorem may then be stated as follows:

$$\sum_R [\Gamma_i(R)_{mn}] [\Gamma_j(R)_{m'n'}]^* = h \delta_{ij} \delta_{mm'} \delta_{nn'} / \sqrt{l_i l_j}$$

.....(1)

This means that in the set of matrices constituting any one irreducible representation any set of corresponding matrix elements, one from each matrix, behaves as the component of a vector in  $h$ -dimensional space such that all these vectors are mutually orthogonal, and each is normalized so that the square of its length equals  $h/l_i$ . This interpretation of (1) will perhaps be more obvious if we take

(1) apart into three simpler equations, each of which is contained within it. We shall omit the explicit designation of complex conjugates for simplicity, but it should be remembered that they must be used when complex numbers are involved. The three simpler equations are as follows:

$$\sum_{\mathbf{R}} \Gamma_i(\mathbf{R})_{mn} \Gamma_j(\mathbf{R})_{mn} = 0 \quad \text{if } i \neq j \dots\dots\dots(2)$$

$$\sum_{\mathbf{R}} \Gamma_i(\mathbf{R})_{mn} \Gamma_i(\mathbf{R})_{m'n'} = 0 \quad \text{if } m \neq m' \quad \text{and/or} \quad n \neq n' \dots\dots\dots(3)$$

$$\sum_{\mathbf{R}} \Gamma_i(\mathbf{R})_{mn} \Gamma_i(\mathbf{R})_{mn} = h/l_i \quad \dots\dots\dots(4)$$

Thus, if the vectors differ by being chosen from matrices of different representations, they are orthogonal (2). If they are chosen from the same representation but from different sets of elements in the matrices of this representation, they are orthogonal (3). Finally, (4) expresses the fact that the square of the length of any such vector equals  $h/l_i$ .

Five important rules:

1. The sum of the squares of the dimensions of the irreducible representations of a group is equal to the order of the group, that is,

$$\sum l_i^2 = l_1^2 + l_2^2 + l_3^2 + l_4^2 + \dots\dots = h$$

2. The sum of the squares of the characters in any irreducible representation equals  $h$ , that is,

$$\sum_{\mathbf{R}} \chi_i(\mathbf{R})^2 = h$$

3. The vectors whose components are the characters of two different irreducible representations are orthogonal, that is,

$$\sum_{\mathbf{R}} \chi_i(\mathbf{R}) \chi_j(\mathbf{R}) = 0 \quad \text{if } i \neq j$$

4. In a given representation (reducible or irreducible) the characters of all matrices belonging to operations in the same class are identical.

5. The number of irreducible representations of a group is equal to the number of classes in the group.

Illustration of five rules:

Important Practical Relationship

Properties of characters of representations:

**Illustration of five rules:**

Let us now consider the irreducible representations of several typical groups to see how these rules apply. The group  $C_{2v}$  consists of four elements, and each is in a separate class. Hence (rule 5) there are four irreducible representations for this group. But it is also required (rule 1) that the sum of the squares of the dimensions of these representations equal  $h$ . Thus we are looking for a set of four positive integers,  $l_1, l_2, l_3,$  and  $l_4,$  which satisfy the relation

$$l_1^2 + l_2^2 + l_3^2 + l_4^2 = 4$$

Clearly the only solution is

$$l_1 = l_2 = l_3 = l_4 = 1$$

Thus the group  $C_{2v}$  has four one-dimensional irreducible representations.

We can actually work out the characters of these four irreducible representations- which are in this case the representations themselves because the dimensions are 1- on the basis of the vector properties of the representations and the rules derived above. One suitable vector in 4-space which has a component of 1 corresponding to E will obviously be

	$E$	$C_2$	$\sigma_v$	$\sigma'_v$
$\Gamma_1$	1	1	1	1

for



$$\sum_R [X_1(R)]^2 = 1^2 + 1^2 + 1^2 + 1^2 = 4$$

thus satisfying rule 2. Now all other representations will have to be such that

$$\sum_R [X_i(R)]^2 = 4$$

which can be true only if each  $X_i(R) = \pm 1$ . Moreover, in order for each of the other representations to be orthogonal to  $\Gamma_1$  (rule 3 and 4.3-7), there will have to be two + 1's and two - 1 's. Thus

$$(1)(-1) + (1)(-1) + (1)(1) + (1)(1) = 0$$

Therefore we will have

	$E$	$C_2$	$\sigma_v$	$\sigma'_v$
$\Gamma_1$	1	1	1	1
$\Gamma_2$	1	-1	-1	1
$\Gamma_3$	1	-1	-1	-1
$\Gamma_4$	1	1	-1	-1

All of these representations are also orthogonal to one another. For example, taking  $\Gamma_2$  and  $\Gamma_4$ , we have

$$(1)(1) + (-1)(1) + (-1)(-1) + (1)(-1) = 0$$

and so on. These are then the four irreducible representations of the group  $C_{2v}$ .

As another example of the working of the rules, let us consider the group  $C_{3v}$ . This consists of the following elements, listed by classes:

$$E \quad C_3 \quad 3 \sigma_v$$

We therefore know at once that there are three irreducible representations.

If we denote their dimensions by  $l_1, l_2$ , and  $l_3$ , we have (rule 1)

$$l_1^2 + l_2^2 + l_3^2 = h = 6$$

The only values of the  $\chi$ , that will satisfy this requirement are 1, 1, and 2. Now once again, and always in any group, there will be a one-dimensional representation whose characters are all equal to 1. Thus we have

	$E$	$2C_3$	$3\sigma_v$
$\Gamma_1$	1	1	1

Note that (from 4.3-9)

$$1^2 + 2(1)^2 + 3(1)^2 = 6$$

We now look for a second vector in 6-space all of whose components are equal to  $\pm 1$  which is orthogonal to  $\Gamma_1$ : The components of such a vector must consist of three +1's and three -1's. Since  $\chi(E)$  must always be positive and since all elements in the same class must have representations with the same character, the only possibility here is

	$E$	$2C_2$	$3\sigma_v$
$\Gamma_1$	1	1	1
$\Gamma_2$	1	-1	-1

Now our third representation will be of dimension 2. Hence  $\chi_3(E) = 2$ .

In order to find out the values of  $\chi_3(C_3)$  and  $\chi_3(\sigma_v)$  we make use of the orthogonality relationships (rule 3, 4.3-7):

$$\sum_R \chi_1(R) \chi_3(R) = [1][2] + 2[1]\chi_3(C_3) + 3[1]\chi_3(\sigma_v) = 0$$

$$\sum_R \chi_2(R) \chi_3(R) = [1][2] + 2[1]\chi_3(C_3) + 3[-1]\chi_3(\sigma_v) = 0$$

Solving these, we obtain

$$2\chi_3(C_3) + 3\chi_3(\sigma_v) = -2$$

$$\underline{-[2\chi_3(C_3) + 3\chi_3(\sigma_v) = -2]}$$

$$6\chi_3(\sigma_v) = 0$$

$$\chi_3(\sigma_v) = 0$$

and

$$2x_3(C_3) + 3(0) = -2$$

$$2x_3(C_3) = -1$$

Thus the complete set of characters of the irreducible representations is

	$E$	$2C_2$	$3\sigma_v$
$\Gamma_1$	1	1	1
$\Gamma_2$	1	1	-1
$\Gamma_3$	1	-1	0

We may note that there is still a check on the correctness of r 3: the square of the length of the vector it defines should be equal to h (rule 2), and we see that this is so:

$$2^2 + 2(-1) + 3(0)^2 = 6$$

### Important Practical Relationship

There is a relationship between any reducible representation of a group and the irreducible representations of that group. In terms of practical application of group theory to molecular problems, this relationship is of pivotal importance. We know already that for any reducible representation it is possible to find some similarity transformation which will reduce each matrix to one consisting of blocks along the diagonal, each of which belongs to an irreducible representation of the group. We also know that the character of a matrix is not changed by any similarity transformation. Thus  $\chi(R)$ , the character of the matrix corresponding to operation in a reducible representation, may be expressed as follows:

$$\chi_i(R) = \sum_j a_j \chi_j(R) \dots \dots \dots (5)$$

where  $a_j$  represents the number of times the block constituting the  $j$ th irreducible representation will appear along the diagonal when the reducible representation is

completely reduced by the necessary similarity transformation. Now we need not to bother about the difficult question of how to find out what matrix is required to reduce completely the reducible representation in order to find the values of the  $a_j$ . We can obtain the required relationship by working only with the characters of all representations in the following way. We multiply each side of (5) by  $\chi_i(R)$  and then sum each side over all operations, namely,

$$\begin{aligned}\sum_R \chi(R) \chi_i(R) &= \sum_R \sum_j a_j \chi_j(R) \chi_i(R) \\ &= \sum_j \sum_R a_j \chi_j(R) \chi_i(R)\end{aligned}$$

Now for each of the terms in the sum over  $j$ , we have

$$\sum_R a_j \chi_j(R) \chi_i(R) = a_j \sum_R \chi_j(R) \chi_i(R) = a_j h \delta_{ij}$$

since the sets of characters  $\chi_j(R)$  and  $\chi_i(R)$  define orthogonal vectors, the squares of whose lengths equal  $h$ . Thus, in summing over all  $j$ , only the sum over  $R$  in which  $i = j$  can survive, and in that case we have

$$\sum_R \chi_j(R) \chi_i(R) = h a_j$$

which we rearrange to read

$$a_j = 1/h \sum_R \chi_j(R) \chi_i(R)$$

Thus we have an explicit expression for the number of times the  $i$ th irreducible representation occurs in a reducible representation where we know only the characters of each representation.

### **Illustrative Examples**

Let us take an example. For the group  $C_{3v}$  we give below the characters of the irreducible representations,  $\Gamma_1$ ,  $\Gamma_2$ , and  $\Gamma_3$  and the characters of two reducible representations,  $\Gamma_a$  and  $\Gamma_b$ :

$C_{3v}$	$E$	$2C_2$	$3\sigma_v$
$\Gamma_1$	1	1	1
$\Gamma_2$	1	1	-1
$\Gamma_3$	2	-1	0
$\Gamma_a$	5	2	-1
$\Gamma_b$	7	1	-3

Using 4.3-1, we find for  $\Gamma_a$

$$a_1 = \frac{1}{6}[1(1)(5) + 2(1)(2) + 3(1)(-1)] = 1$$

$$a_2 = \frac{1}{6}[1(1)(5) + 2(1)(2) + 3(-1)(-1)] = 2$$

$$a_3 = \frac{1}{6}[1(2)(5) + 2(1)(2) + 3(0)(-1)] = 1$$

and for  $\Gamma_b$

$$a_1 = \frac{1}{6}[1(1)(7) + 2(1)(1) + 3(1)(-1)] = 0$$

$$a_2 = \frac{1}{6}[1(1)(7) + 2(1)(1) + 3(-1)(-3)] = 3$$

$$a_3 = \frac{1}{6}[1(2)(7) + 2(-1)(1) + 3(0)(-3)] = 2$$

The numbers in italics are the numbers of elements in each class. The results obtained above will be found to satisfy 4.3-10, as of course they must. for  $\Gamma_a$  we have

	$E$	$2C_2$	$3\sigma_v$
$\Gamma_1$	1	1	1
$\Gamma_2$	1	1	-1
$\Gamma_2$	1	-1	-1
$\Gamma_3$	2	-1	0
$\Gamma_a$	5	2	-1

and for  $\Gamma_b$

	$E$	$2C_2$	$3\sigma_v$
$\Gamma_2$	1	1	-1
$\Gamma_2$	1	1	-1
$\Gamma_2$	1	1	-1
$\Gamma_3$	2	-1	0
$\Gamma_3$	2	-1	0
$\Gamma_b$	7	1	-3

---

### 3.6 Character Table

---

In group theory, a branch of abstract algebra, a character table is a two-dimensional table whose rows correspond to irreducible group representations, and whose columns correspond to conjugacy classes of group elements. The entries consist of characters, the trace of the matrices representing group elements of the column's class in the given row's group representation.

In chemistry, crystallography, and spectroscopy, character tables of point groups are used to classify e.g. molecular vibrations according to their symmetry, and to predict whether a transition between two states is forbidden for symmetry

reasons. Throughout all of our applications of group theory to molecular symmetry we will utilize devices called character tables. In this section the meaning and indicate the source of the information given in these tables has been discussed. For this purpose we shall examine in detail a representative character table, one for the group  $C_{3v}$ , reproduced below. The four main areas of the table have been assigned Roman numerals for reference in the following discussion.

$C_{3v}$	$E$	$2C_3$	$3\sigma_v$			
$A_1$	1	1	1	$z$	$x^2 + y^2, z^2$	
$A_2$	1	1	-1	$R_z$		
$E$	2	-1	0	$(x, y)(R_x, R_y)$	$(x^2 - y^2, xy)(xz, yz)$	
	II		I	III		IV

In the top row are these entries: In the upper left corner is the Schoenflies symbol for the group. Then, along the top row of the main body of the table, are listed the elements of the group, gathered into classes.

**Area I.** In area I of the table are the characters of the irreducible representations of the group. These have been fully discussed in preceding sections of this chapter and require no additional comment here.

**Area II.** We have previously designated the  $i$ th representation, or its set of characters, by the symbol  $F$ , in a fairly arbitrary way. Although this practice is still to be found in some places and is common in older literature, most books and papers—in fact, virtually all those by English-speaking authors—now use the kind of symbols found in the  $C_{3v}$  table above and all tables in Appendix II. This nomenclature was proposed by R. S. Mulliken, and the symbols are normally called Mulliken symbols. Their meanings are as follows:

1. All one-dimensional representations are designated either A or B; two-dimensional representations are designated E; three-dimensional species are designated  $T$  (or sometimes  $F$ ).
2. One-dimensional representations that are symmetric with respect to rotation by  $2\pi/n$  about the principal  $C_n$  axis [symmetric meaning:  $\chi(C_n) = 1$ ] are

designated A, while those antisymmetric in this respect [ $\chi(C_n) = -1$ ] are designated B.

3. Subscripts 1 and 2 are usually attached to A's and B's to designate those which are, respectively, symmetric and antisymmetric with respect to a  $C_2$  perpendicular to the principal axis or, if such a  $C_2$  axis is lacking, to a vertical plane of symmetry.
4. Primes and double primes are attached to all letters, when appropriate, to indicate those which are, respectively, symmetric and antisymmetric with respect to  $\sigma_v$ .
5. In groups with a center of inversion, the subscript  $g$  (from the German *gerade*, meaning even) is attached to symbols for representations which are symmetric with respect to inversion and the subscript  $u$  (from the German *ungerade*, meaning uneven) is used for those which are antisymmetric to inversion.
6. The use of numerical subscripts for  $E$ 's and  $T$ 's also follows certain rules, but these cannot be easily stated precisely without some mathematical development. It will be satisfactory here to regard them as arbitrary labels.

**Area III.** In area III we will always find six symbols:  $x, y, z, R_x, R_y, R_z$ . The first three represent the coordinates  $x, y,$  and  $z,$  while the  $R$ 's stand for rotations about the axes specified in the subscripts. We shall now show in an illustrative but by no means thorough way why these symbols are assigned to certain representations in the group  $C_{3v}$ , and this should suffice to indicate the basis for the assignments in other groups.

Any set of algebraic function or vectors may serve as the basis for a representation of a group. In order to use them for a basis, we consider them to be the components of a vector and then determine the matrices which show how that vector is transformed by each symmetry operation. The resulting matrices, naturally, constitute a representation of the group.

**Area IV.** In this part of the table are listed all of the squares and binary products of coordinates according to their transformation properties. These results are quite easy to work out using the same procedure as for  $x, y,$  and  $z,$  except that the amount



of algebra generally increases, though not always. For example, the pair of functions  $xz$  and  $yz$  must have the same transformation properties as the pair  $x, y$ , since  $z$  goes into itself under all symmetry operations in the group. Accordingly,  $(xz, yz)$  are found opposite the  $E$  representation.

### **Properties of characters of representations:**

Complex conjugation acts on the character table: since the complex conjugate of a representation is again a representation, the same is true for characters, and thus a character that takes on non-trivial complex values has a conjugate character.

Some properties of the group  $G$  can be deduced from its character table:

The order of  $G$  is given by the sum of the squares of the entries of the first column (the degrees of the irreducible characters). Moreover, the sum of the squares of the absolute values of the entries in any column gives the order of the centralizer of an element of the corresponding conjugacy class.

All normal subgroups of  $G$  (and thus whether or not  $G$  is simple) can be recognised from its character table. The kernel of a character  $\chi$  is the set of elements  $g$  in  $G$  for which  $\chi(g) = \chi(1)$ ; this is a normal subgroup of  $G$ . Each and every normal subgroup of  $G$  is the intersection of the kernels of some of the irreducible characters of  $G$ .

The derived subgroup of  $G$  is the intersection of the kernels of the linear characters of  $G$ . In particular,  $G$  is Abelian if and only if all its irreducible characters are linear.

It follows that the prime divisors of the orders of the elements of each conjugacy class of a finite group can be deduced from its character table (an observation of Graham Higman).

The character table does not in general determine the group up to isomorphism: e.g., the quaternion group  $Q$  and the dihedral group of 8 elements ( $D_4$ ) have the same character table. Brauer asked whether the character table, together with the knowledge of how the powers of elements of its conjugacy classes are distributed,

determines a finite group up to isomorphism. The linear characters form a character group, which has important number theoretic connections.

### 3.7 Some examples of character tables

1.  $C_2$  character table.

$C_2$ (2)	$E$	$C_2$	$h = 2$	
A	1	1	$z, R_z$	$x^2, y^2, z^2, xy$
B	1	-1	$x, y, R_x, R_y$	$yz, zx$

2.  $C_3$  character table.

$C_3$ (3)	$E$	$C_3$	$C_3^2$	$\varepsilon = \exp(2\pi i/3)$	$h = 3$
A	1	1	1	$z, R_z$	$x^2 + y^2, z^2$
E	$\begin{Bmatrix} 1 & \varepsilon & \varepsilon^* \\ 1 & \varepsilon^* & \varepsilon \end{Bmatrix}$			$(x, y)(R_x, R_y)$	$(x^2 - y^2, xy) (yz, zx)$

3.  $C_4$  character table.

$C_4$ (4)	$E$	$C_4$	$C_2$	$C_4^3$	$h = 4$	
A	1	1	1	1	$z, R_z$	$x^2 + y^2, z^2$
B	1	-1	1	-1		$x^2 - y^2, xy$
E	$\begin{Bmatrix} 1 & i & -1 & -i \\ 1 & -i & 1 & i \end{Bmatrix}$				$(x, y)(R_x, R_y)$	$(yz, zx)$

4.  $C_{2v}$  character table.

$C_{2v} (2mm)$	$E$	$C_2$	$\sigma_v (xz)$	$\sigma'_v (yz)$	$h = 4$	
$A_1$	1	1	1	1	$z$	$x^2, y^2, z^2$
$A_2$	1	1	-1	-1	$R_z$	$xy$
$B_1$	1	-1	1	-1	$x, R_y$	$zx$
$B_2$	1	-1	-1	1	$y, R_x$	$yz$

5.  $C_{3v}$  character table.

$C_{3v} (3m)$	$E$	$2C_3$	$3\sigma_v$	$h = 6$		
$A_1$	1	1	1	$z$	$x^2 + y^2, z^2$	
$A_2$	1	1	-1	$R_z$		
$E$	2	-1	0	$(x, y) (R_x, R_y)$	$(x^2 - y^2, xy)(zx, yz)$	

6.  $C_{4v}$  character table.

$C_{4v} (4mm)$	$E$	$2C_4$	$C_2$	$2\sigma_v$	$2\sigma_d$	$h = 8$	
$A_1$	1	1	1	1	1	$z$	$x^2 + y^2, z^2$
$A_2$	1	1	1	-1	-1	$R_z$	
$B_1$	1	-1	1	1	-1		$x^2 - y^2$
$B_2$	1	-1	1	-1	1		$xy$
$E$	2	0	-2	0	0	$(x, y) (R_x, R_y)$	$(zx, yz)$

7.  $C_{5v}$  character table.

$C_{5v}$	$E$	$2C_5$	$2C_5^2$	$5\sigma_v$	$h = 10, \alpha = 72^\circ$		
$A_1$	1	1	1	1	$z$	$x^2 + y^2, z^2$	
$A_2$	1	1	1	-1	$R_z$		
$E_1$	2	$2 \cos \alpha$	$2 \cos 2\alpha$	0	$(x, y) (R_x, R_y)$	$(zx, yz)$	
$E_2$	2	$2 \cos 2\alpha$	$2 \cos \alpha$	0		$(x^2 - y^2, xy)$	

8.  $C_{6v}$  character table.

$C_{6v}$ (6mm)	E	$2C_6$	$2C_3$	$C_2$	$3\sigma_v$	$3\sigma_d$	$h = 12$
$A_1$	1	1	1	1	1	1	$z$ $x^2 + y^2, z^2$
$A_2$	1	1	1	1	-1	-1	$R_z$
$B_1$	1	-1	1	-1	1	-1	
$B_2$	1	-1	1	-1	-1	1	
$E_1$	2	1	-1	-2	0	0	$(x, y) (R_x, R_y) (zx, yz)$
$E_2$	2	-1	-1	2	0	0	$(x^2 - y^2, xy)$

9.  $C_{\infty v}$  character table.

$C_{\infty v}$	E	$2C_\phi$	$\infty\sigma_v$	$h = \infty$
$A_1 (\Sigma^+)$	1	1	1	$z$ $x^2 + y^2, z^2$
$A_2 (\Sigma^-)$	1	1	-1	$R_z$
$E_1 (\Pi)$	2	$2 \cos \phi$	0	$(x, y) (R_x, R_y) (zx, yz)$
$E_2 (\Delta)$	2	$2 \cos 2\phi$	0	$(xy, x^2 - y^2)$

10.  $D_2$  character table.

$D_2$ (222)	E	$C_2(z)$	$C_2(y)$	$C_2(x)$	$h = 4$
A	1	1	1	1	$x^2, y^2, z^2$
$B_1$	1	1	-1	-1	$z, R_z$ $xy$
$B_2$	1	-1	1	-1	$y, R_y$ $zx$
$B_3$	1	-1	-1	1	$x, R_x$ $yz$

11.  $D_3$  character table.

$D_3$ (32)	E	$2C_3$	$3C_2$	$h = 6$
$A_1$	1	1	1	$x^2 + y^2, z^2$
$A_2$	1	1	1	$z, R_z$
E	2	-1	0	$(x, y) (R_x, R_y) (x^2 - y^2, xy) (zx, yz)$

12.  $D_{2h}$  character table.

$D_{2h}$ ( $mmm$ )	$E$	$C_2(z)$	$C_2(y)$	$C_2(x)$	$i$	$\sigma(xy)$	$\sigma(xz)$	$\sigma(yz)$	$h = 8$
$A_g$	1	1	1	1	1	1	1	1	$x^2, y^2, z^2$
$B_{1g}$	1	1	-1	-1	1	1	-1	-1	$R_z$ $xy$
$B_{2g}$	1	-1	1	-1	1	-1	1	-1	$R_y$ $zx$
$B_{3g}$	1	-1	-1	1	1	-1	-1	1	$R_x$ $yz$
$A_u$	1	1	1	1	-1	-1	-1	-1	
$B_{1u}$	1	1	-1	-1	-1	-1	1	1	$z$
$B_{2u}$	1	-1	1	-1	-1	1	-1	1	$y$
$B_{3u}$	1	-1	-1	1	-1	1	1	-1	$x$

13.  $D_{3h}$  character table.

$D_{3h}$ ( $6m2$ )	$E$	$2C_3$	$3C_2$	$\sigma_h$	$2S_3$	$3\sigma_v$	$h = 12$
$A'_1$	1	1	1	1	1	1	$x^2 + y^2, z^2$
$A'_2$	1	1	-1	1	1	-1	$R_z$
$E'$	2	-1	0	2	-1	0	$(x, y)$ $(x^2 - y^2, xy)$
$A''_1$	1	1	1	-1	-1	-1	
$A''_2$	1	1	-1	-1	-1	1	$z$
$E''$	2	-1	0	-2	1	0	$(R_x, R_y)$ $(zx, yz)$

14.  $D_{4h}$  character table.

$D_{4h}$ ( $4/mmm$ )	$E$	$2C_4$	$C_2$	$2C'_2$	$2C''_2$	$i$	$2S_4$	$\sigma_h$	$2\sigma_v$	$2\sigma_d$	$h = 16$
$A_{1g}$	1	1	1	1	1	1	1	1	1	1	$x^2 + y^2, z^2$
$A_{2g}$	1	1	1	-1	-1	1	1	1	-1	-1	$R_z$
$B_{1g}$	1	-1	1	1	-1	1	-1	1	1	-1	$x^2 - y^2$
$B_{2g}$	1	-1	1	-1	1	1	-1	1	-1	1	$xy$
$E_g$	2	0	-2	0	0	2	0	-2	0	0	$(R_x, R_y)$ $(zx, yz)$
$A_{1u}$	1	1	1	1	1	-1	-1	-1	-1	-1	
$A_{2u}$	1	1	1	-1	-1	-1	-1	-1	1	1	$z$
$B_{1u}$	1	-1	1	1	-1	-1	1	-1	-1	1	
$B_{2u}$	1	-1	1	-1	1	-1	1	-1	1	-1	
$E_u$	2	0	-2	0	0	-2	0	2	0	0	$(x, y)$

### 15. $D_{5h}$ character table.

$D_{5h}$	$E$	$2C_5$	$2C_5^2$	$5C_2$	$\sigma_h$	$2S_5$	$2S_5^2$	$5\sigma_v$	$h = 20, \alpha = 72^\circ$
$A_1'$	1	1	1	1	1	1	1	1	$x^2 + y^2, z^2$
$A_2''$	1	1	1	-1	1	1	1	-1	$R_z$
$E_1'$	2	$2\cos\alpha$	$2\cos 2\alpha$	0	2	$2\cos\alpha$	$2\cos 2\alpha$	0	$(x, y)$
$E_2'$	2	$2\cos 2\alpha$	$2\cos\alpha$	0	2	$2\cos 2\alpha$	$2\cos\alpha$	0	$(x - y^2, xy)$
$A_1''$	1	1	1	1	-1	-1	-1	-1	
$A_2''$	1	1	1	-1	-1	-1	-1	1	$z$
$E_1''$	2	$2\cos\alpha$	$2\cos 2\alpha$	0	-2	$-2\cos\alpha$	$-2\cos 2\alpha$	0	$(R_x, R_y)$ $(zx, yz)$
$E_2''$	2	$2\cos 2\alpha$	$2\cos\alpha$	0	-2	$-2\cos 2\alpha$	$-2\cos\alpha$	0	

## 3.8 Summary

This chapter discusses with the symmetry operations, representations of groups, the great orthogonality theorem, character tables. One can understand these topics after reading this chapter.

## 3.9 Review Questions

1. Discuss symmetry operations.
2. What do you mean by representation of group? discuss it in detailed.
3. Write detailed notes on the great orthogonality theorem.
4. What do you mean by character table? Discuss various areas of character table.
5. Write short note on properties of character table.
6. Draw the character table for the  $C_{2v}$  and  $C_{3v}$  point group.

## 3.10 Glossary

1. Symmetry: Symmetry has two meanings. The first is a vague sense of harmonious and beautiful proportion and balance. The second is an exact mathematical "patterned self-similarity" that can be demonstrated with the rules of a formal system, such as geometry or physics.
2. Point group: point group is a group of geometric symmetries (isometries) that keep at least one point fixed. Point groups can exist in a Euclidean

space with any dimension, and every point group in dimension  $d$  is a subgroup of the orthogonal group

3. Irreducible representation: It is a nontrivial representation with no nontrivial proper subrepresentations. Similarly, an irreducible module is another name for a simple module.

---

### **3.11 References and Suggested Readings**

---

1. Chemical application of group theory by F. A Cotton
2. Shriver and Atkin's inorganic chemistry fifth edition.
3. Physical chemistry by P. Atkins and J. D. Paula, Ninth edition

---

# Unit - 4 : Group Theory and Quantum Mechanics

---

## Structure of unit

- 4.1 Objective
- 4.2 Introduction
- 4.3 Wave function as basis for irreducible representations
- 4.4 The direct product
- 4.5 How Direct Products Are Used
- 4.6 Identifying nonzero matrix elements
- 4.7 Spectral Transition Probabilities
- 4.8 Summary
- 4.9 Review Questions
- 4.10 Glossary
- 4.11 References and Suggested Readings

---

## 4.1 Objective

---

This chapter is introduced into the syllabus so that one can understand the relation between group theory and quantum mechanics. In another words, in this chapter quantum mechanics is being correlated with the group theory.

---

## 4.2 Introduction

---

In mathematics and abstract algebra, group theory studies the algebraic structures known as groups. The concept of a group is central to abstract algebra: other well-known algebraic structures, such as rings, fields, and vector spaces can all be seen as groups endowed with additional operations and axioms. Groups recur throughout mathematics, and the methods of group theory have influenced many parts of algebra. Linear algebraic groups and Lie groups are two branches of group



theory that have experienced advances and have become subject areas in their own right. Various physical systems, such as crystals and the hydrogen atom, can be modelled by symmetry groups. Thus group theory and the closely related representation theory have many important applications in physics and chemistry.

Quantum mechanics is a branch of physics which deals with physical phenomena at nanoscopic scales where the action is on the order of the Planck constant. It departs from classical mechanics primarily at the quantum realm of atomic and subatomic length scales. Quantum mechanics provides a mathematical description of much of the dual particle-like and wave-like behavior and interactions of energy and matter. Quantum mechanics provides a substantially useful framework for many features of the modern periodic table of elements including the behavior of atoms during chemical bonding and has played a significant role in the development of many modern technologies.

In advanced topics of quantum mechanics, some of these behaviors are macroscopic and emerge at only extreme energies or temperatures. For example, the angular momentum of an electron bound to an atom or molecule is quantized. In contrast, the angular momentum of an unbound electron is not quantized. In the context of quantum mechanics, the wave–particle duality of energy and matter and the uncertainty principle provide a unified view of the behavior of photons, electrons, and other atomic-scale objects.

The mathematical formulations of quantum mechanics are abstract. A mathematical function, the wavefunction, provides information about the probability amplitude of position, momentum, and other physical properties of a particle. Mathematical manipulations of the wavefunction usually involve bra–ket notation which requires an understanding of complex numbers and linear functionals. The wavefunction formulation treats the particle as a quantum harmonic oscillator, and the mathematics is akin to that describing acoustic resonance. Many of the results of quantum mechanics are not easily visualized in terms of classical mechanics. For instance, in a quantum mechanical model the lowest energy state of a system, the ground state, is non-zero as opposed to a more "traditional" ground state with zero kinetic energy (all particles at rest). Instead of a

traditional static, unchanging zero energy state, quantum mechanics allows for far more dynamic, chaotic possibilities

---

### 4.3 Wave function as basis for irreducible representations

---

The wave equation for any physical system is

$$H\Psi = E\Psi \quad (1)$$

Here  $H$  is the Hamiltonian operator, which indicates that certain operations are to be carried out on a function written to its right. The wave equation states that, if the function is an eigenfunction, the result of performing the operations indicated by  $H$  will yield the function itself multiplied by a constant that is called an eigenvalue. Eigenfunctions are conventionally denoted ' $\Psi$ ', and the eigenvalue, which is the energy of the system, is denoted  $E$ .

The Hamiltonian operator is obtained by writing down the expression for the classical energy of the system, which is simply the sum of the potential and kinetic energies for systems of interest to us, and then replacing the momentum terms by differential operators according to the postulates of wave mechanics. We need not concern ourselves with this construction of the Hamiltonian operator in any detail. The only property of it which we shall have to use explicitly concerns its symmetry with respect to the interchange of like particles in the system to which it applies. The particles in the system will be electrons and atomic nuclei. If any two or more particles are interchanged by carrying out a symmetry operation on the system, the Hamiltonian must be unchanged. A symmetry operation carries the system into an equivalent configuration, which is, by definition, physically indistinguishable from the original configuration. Clearly then, the energy of the system must be the same before and after carrying out the symmetry operation. Thus we say that any symmetry operator,  $R$ , commutes with the Hamiltonian operator, and we can write

$$RH = HR \quad (2)$$

The Hamiltonian operator also commutes with any constant factor  $c$ . Thus

$$Hc\Psi = cH\Psi = cE\Psi \quad (3)$$

It has been more or less implied up to this point that for any eigenvalue  $E$  there is one appropriate eigenfunction  $E_i$ . This is often true, but there are also many cases in which several eigenfunctions give the same eigenvalue, for example,

$$\begin{aligned}
 H\psi_{i1} &= E_i \psi_{i1} \\
 H\psi_{i2} &= E_i \psi_{i2} \\
 \dots &\quad \dots \\
 H\psi_{ik} &= E_i \psi_{ik}
 \end{aligned} \tag{4}$$

In such cases we say that the eigenvalue is degenerate, and in the particular example given above we would say that the energy  $E$  is  $k$ -fold degenerate. Now in the case of a degenerate eigenvalue, not only does the initial set of eigenfunctions provide correct solutions to the wave equation, but any linear combination of these is also a solution giving the same eigenvalue. This is easily shown as follows:

$$\begin{aligned}
 H \sum_j a_{ij} \psi_{ij} &= H a_{i1} \psi_{i1} + H a_{i2} \psi_{i2} + H a_{i3} \psi_{i3} + \dots + H a_{ik} \psi_{ik} \\
 &= E a_{i1} \psi_{i1} + E a_{i2} \psi_{i2} + E a_{i3} \psi_{i3} + \dots + E a_{ik} \psi_{ik} \\
 &= E \sum_j a_{ij} \psi_{ij}
 \end{aligned} \tag{5}$$

One more important property of eigenfunctions must be mentioned. Eigenfunctions are so constructed as to be orthonormal, which means that

$$\int \psi_i^* \psi_j dt = \delta_{ij} \tag{6}$$

where the integration is to be carried out over all of the coordinates, collectively represented by  $t$ , which occur in ' $\psi_i$ ' and ' $\psi_j$ '. When an eigenfunction belonging to the eigenvalue  $E_i$  is expressed as a linear combination of a set of eigenfunctions, we have, from 6,

$$\int \psi_i^* \psi_j dt = \int \sum_j (a_{ij} \psi_{ij}^*) \sum_j (a_{ij} \psi_{ij}) dt$$

Now all products where  $i \neq j$  will vanish, for example,

$$\int a_{ij} a_{ij'} \psi_{ij}^* \psi_{ij'} dt = a_{ij} a_{ij'} \int \psi_{ij}^* \psi_{ij'} dt = 0$$

and, assuming that each  $\psi_{ij}$  is normalized, we are left with

$$\int \sum_j a_{ij} a_{ij} \Psi_{ij}^* \Psi_{ij} dt = \sum_j a_{ij}^2 = 1 \quad (7)$$

We can now show that the eigenfunctions for a molecule are bases for irreducible representations of the symmetry group to which the molecule belongs. Let us take first the simple case of non degenerate eigenvalues. If we take the wave equation for the molecule and carry out a symmetry operation,  $R$ , upon each side, then, from (1) and (2) we have

$$HR\Psi_i = E_i R\Psi_i \quad (8)$$

Thus  $R\Psi_i$  is itself an eigenfunction. Since  $\Psi$  is normalized, we must require, in order that  $R\Psi_i$  also be normalized,

$$R\Psi_i = \pm \Psi_i$$

Hence, by applying each of the operations in the group to an eigenfunction  $\Psi_i$  belonging to a nondegenerate eigenvalue, we generate a representation of the group with each matrix  $\Gamma_i(R)$ , equal to  $\pm 1$  are one dimensional, they are obviously irreducible.

If we take the wave equation for the case where  $E_1$  is  $k$ -fold degenerate, then we must write, in analogy to (8).

$$HR\Psi_{il} = \pm E_i R\Psi_{il} \quad (9)$$

But here  $R\Psi_{il}$  may in general be any linear combination of the  $\Psi_{ij}$  that is,

$$R\Psi_{il} = \sum_{j=1}^k r_{ij} \Psi_{ij} \quad (10)$$

For some other operation,  $S$ , we have similarly,

$$S\Psi_{ij} = \sum_{m=1}^k s_{mj} \Psi_{im} \quad (11)$$

Because  $R$  and  $S$  are members of a symmetry group, there must be an element  $T = SR$ ; its effect on  $\Psi_{il}$  can be expressed as

$$T\Psi_{ij} = \sum_{m=1}^k t_{ml} \Psi_{im} \quad (12)$$

However, by combining the preceding expressions for the separate effects of  $S$  and  $R$ , we obtain

$$SR\psi_{ij} = S \sum_{m=1}^k r_{jl} \psi_{ij} = \sum_{j=1}^k \sum_{m=1}^k S_{mj} r_{jl} \psi_{im} \quad (13)$$

Comparing (12) with (13), we see that

$$t_{ml} = \sum_{j=1}^k S_{mj} r_{jl}$$

Let us consider the  $2p_x$  and  $2p_y$  orbitals of the nitrogen atom in ammonia, which belongs to the group  $C_{3v}$ . These orbitals are represented or described by the following eigenfunctions:

$$p_x = \psi_r \sin\theta \cos\phi$$

$$p_y = \psi_r \sin\theta \sin\phi$$

where  $\psi_r$  is angle independent and thus a constant insofar as symmetry operations are concerned; we shall therefore omit it henceforth.  $\theta$  and  $\phi$  are angles in a polar coordinate system  $\theta$  stands for an angle measured down from a reference axis, say the  $z$  axis, and  $\phi$  denotes an angle measured in the counterclockwise direction from the  $x$  axis in the  $xy$  plane. Let us now work out the matrices that represent the transformations of these functions by each of the symmetry operations in the group  $C_{3v}$ . We consider what happens to a line whose direction is fixed initially by the angles  $\theta$  and  $\phi$ . First of all we note that none of the operations in the group will affect  $\theta$ , so that  $\theta_2$ , the value of  $\theta$  after application of a symmetry operation, will always equal  $\theta_1$ . Hence

$$\sin\theta = \sin\theta_1$$

If we rotate by  $2\pi/3$  about the  $z$  axis, however, we have

$$\phi_2 = \phi_1 + 2\pi/3$$

and hence

$$\cos\phi_2 = \cos(\phi_1 + 2\pi/3) = \cos\phi_1 \cos 2\pi/3 - \sin\phi_1 \sin 2\pi/3$$

$$\begin{aligned}
&= -\frac{1}{2} \cos \phi_1 - \frac{\sqrt{3}}{2} \sin \phi_1 \\
\sin \phi_2 &= \sin(\phi_1 + 2\pi/3) = \sin \phi_1 \cos 2\pi/3 + \cos \phi_1 \sin 2\pi/3 \\
&= -\frac{1}{2} \sin \phi_1 + \frac{\sqrt{3}}{2} \cos \phi_1
\end{aligned}$$

If we reflect in the  $xz$  plane, we have

$$\begin{aligned}
\phi_2 &= -\phi_1 \\
\cos \phi_2 &= \cos \phi_1 \\
\sin \phi_2 &= -\sin \phi_1
\end{aligned}$$

We can now use this information to work out the required matrices.

$E$ :

$$\begin{aligned}
Ep_x &= E(\sin \theta_1 \cos \phi_1) = \sin \theta_2 \cos \phi_2 = \sin \theta_1 \cos \phi_1 = p_x \\
Ep_y &= E(\sin \theta_1 \sin \phi_1) = \sin \theta_2 \sin \phi_2 = \sin \theta_1 \sin \phi_1 = p_y
\end{aligned}$$

$C_3$ :

$$\begin{aligned}
C_3 p_x &= C_3(\sin \theta_1 \cos \phi_1) = \sin \theta_2 \cos \phi_2 \\
&= (\sin \theta_1) \left(-\frac{1}{2}\right) (\cos \phi_1 + \sqrt{3} \sin \phi_1) \\
&= -\frac{1}{2} \sin \theta_1 \cos \phi_1 - \frac{\sqrt{3}}{2} \sin \theta_1 \sin \phi_1 \\
&= -\frac{1}{2} p_x - \frac{\sqrt{3}}{2} p_y
\end{aligned}$$

$$\begin{aligned}
C_3 p_y &= C_3(\sin \theta_1 \sin \phi_1) = \sin \theta_2 \sin \phi_2 \\
&= (\sin \theta_1) \left(-\frac{1}{2}\right) (\sin \phi_1 - \sqrt{3} \cos \phi_1) \\
&= \frac{\sqrt{3}}{2} \sin \theta_1 \cos \phi_1 - \frac{1}{2} \sin \theta_1 \sin \phi_1 \\
&= \frac{\sqrt{3}}{2} p_x - \frac{1}{2} p_y
\end{aligned}$$

$\sigma_v$ :

$$\begin{aligned}
\sigma_v p_x &= \sigma_v(\sin \theta_1 \cos \phi_1) = \sin \theta_2 \cos \phi_2 = \sin \theta_1 \cos \phi_1 = p_x \\
\sigma_v p_y &= \sigma_v(\sin \theta_1 \sin \phi_1) = \sin \theta_2 \sin \phi_2 = -\sin \theta_1 \sin \phi_1 = -p_y
\end{aligned}$$

Expressing these results in matrix notation, we write

$$\begin{bmatrix} 1 & 0 \\ 0 & 1 \end{bmatrix} \begin{bmatrix} p_x \\ p_y \end{bmatrix} = E \begin{bmatrix} p_x \\ p_y \end{bmatrix} \quad \chi(E) = 2$$

$$\begin{bmatrix} -1/2 & -\sqrt{3}/2 \\ \sqrt{3}/2 & -1/2 \end{bmatrix} \begin{bmatrix} p_x \\ p_y \end{bmatrix} = C_3 \begin{bmatrix} p_x \\ p_y \end{bmatrix} \quad \chi(C_3) = -1$$

$$\begin{bmatrix} 1 & 0 \\ 0 & -1 \end{bmatrix} \begin{bmatrix} p_x \\ p_y \end{bmatrix} = \sigma_v \begin{bmatrix} p_x \\ p_y \end{bmatrix} \quad \chi(\sigma_v) = 0$$

The characters are seen to be those of the  $E$  representation of  $C_{3v}$ . Thus we see that the  $p_x$  and  $p_y$  orbitals, as a pair, provide a basis for the  $E$  representation. It will be noted that the coordinates  $x$  and  $y$  are shown as transforming according to the  $E$  representation in the character table for the group  $C_{3v}$ . Thus the functions  $\sin\theta \cos\phi$  and  $\sin\theta \sin\phi$  transform in the same way as  $\underline{x}$  and  $\underline{y}$ . This reason the  $p$  orbital that has an eigenfunction  $\sin\theta \cos\phi$  is called  $p_x$  the one that has an eigenfunction  $\sin\theta \sin\phi$  is called  $p_y$ .

---

#### 4.4 The direct product

---

Suppose that  $R$  is an operation in the symmetry group of a molecule and  $X_1, X_2, \dots, X_m$  and  $Y_1, Y_2, \dots, Y_n$  are two sets of functions (perhaps eigenfunctions of the wave equation for the molecule), which are bases for representations of the group. As shown earlier, we may write

$$RX_i = \sum_{j=1}^m x_{ji} X_j$$

$$RY_k = \sum_{l=1}^n y_{lk} Y_l$$

It is also true that

$$RX_i Y_k = \sum_{j=1}^m \sum_{l=1}^n x_{ji} y_{lk} X_j Y_l = \sum_j \sum_l z_{jl,ik} X_j Y_l$$

Thus the set of functions  $X_i Y_k$  called the direct product of  $X_i$  and  $Y_k$  forms a basis for a representation of the group. The  $Z_{jl,ik}$  are the elements of a matrix  $Z$  of order  $(mn) \times (mn)$ .

We now have a very important theorem about the characters of the  $Z$  matrices for the various operations in the group:

The characters of the representation of a direct product are equal to the products of the characters of the representations based on the individual sets of functions.

PROOF: This theorem is easily proved as follows:

$$X_Z(R) = \sum_{ji} Z_{ji,ji} = \sum_{j=1}^m \sum_{l=1}^n X_{jj} Y_{ll} = X_x(R) X_y(R)$$

Thus, if we want to know the characters  $X(R)$  of a representation that is the direct product of two other representations with characters  $X_1(R)$  and  $X_2(R)$ , these are given by

$$X(R) = X_1(R) X_2(R)$$

for each operation  $R$  in the group.

For example, the direct products of some irreducible representations of the group  $C_{4v}$  are as follows:



$C_{4v}$	$E$	$2C_2$	$2C_4$	$2\sigma_v$	$2\sigma_d$
$A_2$	1	1	1	1	1
$A_2$	1	1	1	-1	-1
$B_1$	1	1	-1	1	-1
$B_2$	1	1	-1	-1	1
$E$	2	-2	0	0	0
$A_2A_2$	1	1	1	1	-1
$B_1E$	2	-2	0	0	0
$A_1EB_2$	2	-2	0	0	0
$E^2$	4	4	0	0	0

It should be clear from the associative property of matrix multiplication that what has been said regarding direct products of two representations can be extended to direct products of any number of representations.

In general, though not invariably the direct product of two or more irreducible representations will be a reducible representation. For example, the direct product representations of the group given above reduce in the following way:

$$\begin{aligned}
 A_1A_2 &= A_2 & E^2 &= A_1 + A_2 + B_1 + B_2 \\
 B_1E &= E \\
 A_1EB_2 &= E
 \end{aligned}$$

---

## 4.5 How direct products are used

---

we shall now explain the importance of direct products in the solution of problems in molecular quantum mechanics. Whenever we have an integral of the product of two functions, for example,

$$\int f_A f_B d\tau$$

the value of this integral will be equal to zero unless the integrand is invariant under all operations of the symmetry group to which the molecule belongs or unless some term in it, if it can be expressed as a sum of terms, remains invariant. This is

generalization of the familiar case in which an integrand is a function of only one variable, In that case, if  $y = f(x)$ , the integral

$$\int_{-x}^x y dx$$

equals zero if  $y$  is an odd function, that is, if  $f(x) = -f(-x)$ . In this simple case we say that  $y$  is not invariant to the operation of reflecting all points in the second and third quadrants into the first and fourth quadrants and vice versa.

Now we say that the integrand  $f_A f_B$  is invariant to all symmetry operations, this means that it forms a basis for the totally symmetric representation. But from what has been said above, we know how to determine the irreducible representations occurring in the representation  $\Gamma_{AB}$  for which  $f_A f_B$  forms a basis if we know the irreducible representations for which  $f_A$  and  $f_B$  separately form bases. In general:

$\Gamma_{AB}$  = a sum of irreducible representations

only if one of the irreducible representations occurring, in the sum is the totally symmetric one will the integral have a value other than zero. There is a theorem concerning whether the totally symmetric representation will be present in this sum:

The representation of a direct product  $\Gamma_{AB}$  will contain the totally symmetric representation only if the irreducible  $\Gamma_A$  = the irreducible  $\Gamma_B$ .

PROOF: The  $i$ th irreducible representation,  $\Gamma_i$  occurs in a reducible representation say  $\Gamma_{AB}$ , is given by

$$a_i = \frac{1}{h} \sum_R X_{AB}(R) X_i(R)$$

If  $a_i$  and  $X_i$  refer to the totally symmetric representation, for which all  $X_i(R)$  equal 1, we have

$$a_1 = \frac{1}{h} \sum_R X_{AB}(R)$$

But

$$X_{AB}(R) = X_A(R) X_B(R)$$

Hence

$$a_1 = \frac{1}{h} \sum_R X_A(R) X_B(R)$$

According to the properties of characters of irreducible representations as components of vectors, we obtain

$$a_1 = \delta_{AB} \text{ Q.E.D.}$$

We also see that if  $\Gamma_1$  occurs at all it will occur only once. Many other examples may be discussed to develop familiarity with the manipulation of direct products.

### Illustrative Example

#### 1. Group $D_4$

The character table for this group should be very familiar, since it was derived in toto earlier. It should be obvious that the direct product of any two different irreducible representations must yield a representation containing two -1's, which will not, therefore be an  $A_1$  representation. It is also apparent that no direct product of  $A_1$ ,  $A_2$ ,  $B_1$  or  $B_2$  with  $E$  can be other than  $E$ . The only remaining direct product is  $E \times E$ . This has the characters

$E$	$2C_4$	$C_2$	$2C_2^{11}$	$2C_2^{11}$
4	0	4	0	0

It should contain the  $A_1$  representation, and it does:

$$a_{A_1} = \frac{1}{8} [4 + 0 + 4 + 0 + 0] = 1$$

From the foregoing discussion of the integrals of products of two functions it is easy to derive some important rules regarding integrands that are products of three, four, or more functions. The case of a triple product is of particular importance. In order for the integral

$$\int f_A f_B f_C d\tau$$

to be nonzero, the direct product of the representation of  $f_A$ ,  $f_B$  and  $f_C$  must be o(contain the totally symmetric representation That his an happen only it the representation of the direct product of any two of the function Is or contains the same representation as is given by the third function follow directly from this theorem. This corollary is applicable chiefly in dealing with matrix elements of the type

$$\int \psi_i P \psi_j d\tau \quad (14)$$

where  $\psi_i$ , and  $\psi_j$  are wave functions, and  $P$  is some quantum mechanical operator.

---

## 4.6 Identifying nonzero matrix elements

---

Integrals of the general type (14) occur frequently in quantum mechanical problems. They are often termed matrix elements, since they occur as such

If we take the wave equation

$$H \psi_i = E \psi_i$$

left-multiply it by  $\psi_i$  integrate both sides, and rearrange slightly, we obtain

$$\frac{\int \psi_i H \psi_i d\tau}{\int \psi_i \psi_i d\tau} = E$$

we thus have an explicit expression for an energy, which can be thought of as the energy of interaction between two states described by the wave function  $\psi_i$  and  $\psi_j$ . if the integral that occurs in the numerator of the left hand side of this equation is in fact required to have a value identically equal to zero, it will be helpful to know this at the earliest possible stage of a calculation so that no computational effort will be wasted on it. This information may be obtained very simply from a knowledge of the irreducible representations to which the wave functions  $\psi_i$  and  $\psi_j$  belong.

we note first that the Hamiltonian operator must have the full symmetry of the molecule; it is simply an operator expression for the energy of the molecule, and clearly the energy of the molecule cannot change in either sign or magnitude as a result of a symmetric representation, and the symmetry of the entire integrand  $\psi_i$

$H \psi_j$  depends entirely on the representations contained in the direct product of the representation  $\psi_i$  and  $\psi_j$ . The totally symmetric representation can occur in this direct product representation only if  $\psi_i$  and  $\psi_j$  belong to the same irreducible representation. Thus we have the completely general and enormously useful theorem that:

An energy integral  $\int \psi_i H \psi_i d\tau$  may be nonzero only if  $\psi_i$  and  $\psi_j$  belong to the same irreducible representation of the molecular point group.

---

## 4.7 Spectral Transition Probabilities

---

Perhaps the second commonest case in which the simple question of whether or not a matrix element is required by symmetry considerations to vanish occurs in connection with selection rules for various types of transition from one stationary state of a system to another with the gain or loss of a quantum of energy. If the energy difference between the states is represented by  $E_i - E_j$ , then radiation of frequency  $\nu$  will be either absorbed or emitted by the transition, if it is allowed, with  $\nu$  being required to satisfy the equation

$$h\nu = E_i - E_j$$

In general the intensity,  $I$ , of a transition from a state described by  $\psi_i$  to another described by  $\psi_j$  is given by an equation of the type

$$I \propto \int \psi_i \mu \psi_j d\tau \quad (15)$$

The symbol  $\mu$  is a transition moment operator; of which there are various kinds, namely, those corresponding to changes in electric or magnetic dipoles higher electric or magnetic multiples, or polarizability tensors.

The commonest type of transition, and the only one to be considered right now, is the electric dipole-allowed transition. In this type the charge distributions in the two states differ in a manner corresponding to an electric dipole.

Such a transition can therefore couple with electromagnetic radiation by interaction with the oscillating electric vector and thereby transfer energy to or from

the electromagnetic field. Both theory and experiment show that normally this is by far the most powerful intensity-giving process, and the statement that a transition is allowed, without further qualification, means explicitly "electric dipole allowed."

The electric dipole operator has the form

$$\mu = \sum_i e_i x_i + \sum_i e_i y_i + \sum_i e_i z_i$$

where  $e_i$  represents the charge on the  $i$ th particle and  $x_i, y_i, z_i$  are its Cartesian coordinates. When this expression is introduced into (15), we obtain a result which is usefully expressed as three separate equations because of the orthogonality of the Cartesian coordinates:

$$\begin{aligned} I_x &\propto \int \psi_i x \psi_j d\tau \\ I_y &\propto \int \psi_i y \psi_j d\tau \\ I_z &\propto \int \psi_i z \psi_j d\tau \end{aligned} \tag{16}$$

In these equations scalar quantities such as the  $e_j$  have been omitted, and summation over all particles is assumed.

These equations mean that the transition from the  $i$ th to the  $j$ th state (or the reverse) may acquire its intensity in any of three ways namely, by interacting with an electric vector oscillating in the  $x$ ,  $y$ , or the  $z$  direction. If it is only the integral  $\int \psi_i x \psi_j d\tau$  that is nonzero, we say that the transition is polarized in the  $x$  direction or that it is  $x$ , polarized. In cases of sufficiently high molecular symmetry, where  $x$  and  $y$  jointly form the basis for an irreducible representation, the integrals involving  $x$  and  $y$  will not be independent of each other. If both are nonzero the transition is said to be  $xy$  polarized. In problems with some kind of cubic or higher symmetry (point groups  $T, T_h, T_d, O, O_h, I, I_h$ ), where the three Cartesian coordinates jointly form a basis for some three-dimensional representation, no polarization effect exists. Radiation with an electric vector in any direction will excite the transition if it is allowed at all. Thus the problem of deciding whether a certain transition is electric dipole allowed, and what the polarization is, reduces to that of deciding which, if any, of the three integrals in (16) are nonzero. We can

always ascertain to what representations the Cartesian coordinates belong by inspection of the character table of the molecular point group. Then we have the following rule:

*An electric dipole transition will be allowed with x, or Z polarization if the direct product of the representations of the two states concerned is or contains the irreducible representation to which x, y, or z, respectively, belongs.*

### Illustrative Example

- Metal-Based Electronic Excitations of  $MO_2X_8^{4-}$  Species

The  $MO_2X_8^{4-}$  ions, for example,  $MO_2X_8^{4-}$  have the square parallelepiped structure shown below, and therefore belong to point group  $D_{4h}$ . Their highest occupied molecular orbital (HOMO) is a  $\delta$  orbital and the lowest unoccupied molecular orbital (LUMO) is a  $\delta^*$  orbital. These two orbitals are composed almost entirely of the atomic  $d_{xy}$  orbitals, combined as shown below.

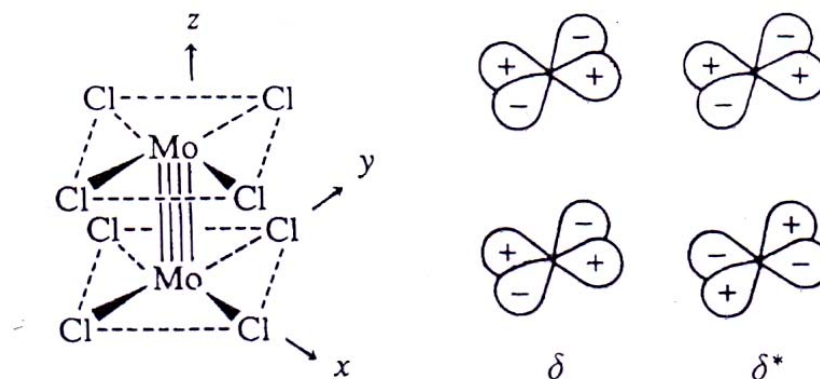

We can ask whether the  $\delta \rightarrow \delta^*$  transition of an electron is allowed and, if so, with what polarization (a coordinate system is shown). We must first determine the irreducible representations for which each of the orbitals,  $\delta$  and  $\delta^*$ , forms a basis. This can easily be done using the  $D_{4h}$  character table.

Each of these orbitals forms the basis for a one-dimensional representation (and thus an irreducible one); when subjected to each of the symmetry operations (or one from each class) the following results are obtained. 1 means the orbital goes

into itself (no signs changed) and -1 means it goes into the negative of itself (all signs changed):

	$E$	$2C_4$	$C_2$	$2C'_2$	$2C''_2$	$1$	$2S_4$	$\sigma_h$	$2\sigma_v$	$2\sigma_d$
$\delta$	1	-1	1	1	-1	1	-1	1	1	-1
$\delta^*$	1	-1	1	-1	1	-1	1	-1	1	-1

Reference to the  $D_{4h}$  character table shows that these are of  $B_{1g}(\delta)$  and  $B_{2g}(\delta^*)$  Symmetries.

The intensity of a  $\bar{\delta} \rightarrow \bar{\delta}^*$  transition will be governed by the magnitude of the integral(s).

$$\int \Psi_{\delta}(x, y, z) \Psi_{\delta^*} d\tau$$

Our task here is to determine whether any of the three Cartesian components is nonzero. Since, in  $D_{4h}$  the  $z$  vector transforms according to the  $A_{2u}$  representation and  $x$  and  $y$  jointly according to the  $E_u$  representation, we need to know whether either of the direct products,  $B_{1g} \times A_{2u} \times B_{2u}$  or  $B_{1g} \times E_u \times B_{2u}$  contains the  $A_{1g}$  representation. It is a simple matter to show that the first one is equal to  $A_{1g}$  while the second is equal to  $E_g$ . Thus, the  $\bar{\delta} \rightarrow \bar{\delta}^*$  transition is electric-dipole allowed with  $z$  polarization and forbidden for radiation with electric vector in the  $xy$  plane.

---

## 4.8 Summary

---

This chapter is introduced into the syllabus so that one can understand the relation between group theory and quantum mechanics. In another words, in this chapter quantum mechanics is being correlated with the group theory.

---

## 4.9 Review Questions

---

1. How wave function can be used as a basis for irreducible presentation?. Describe in details.



2. What do you mean by the direct product?
3. Explain how direct products are used.

---

## 4.10 Glossary

---

1. Quantum mechanics: it is a branch of physics which deals with physical phenomena at nanoscopic scales where the action is on the order of the Planck constant.
2. Wave function: A wave function or wavefunction (also named a state function) in quantum mechanics describes the quantum state of a system of one or more particles, and contains all the information about the system. Quantities associated with measurements, like the average momentum of a particle, are derived from the wavefunction.
3. Eigenfunction: In mathematics, an eigenfunction of a linear operator,  $A$ , defined on some function space, is any non-zero function  $f$  in that space that returns from the operator exactly as is, except for a multiplicative scaling factor.
4. Eigen value: An eigenvector of a square matrix  $A$  is a non-zero vector  $v$  that, when the matrix is multiplied by  $v$ , yields a constant multiple of  $v$ , the multiplier being commonly denoted by  $\lambda$ . That is:

$$A v = \lambda v$$

5. The number  $\lambda$  is called the eigenvalue of  $A$  corresponding to  $v$ .

---

## 4.11 References and Suggested Readings

---

1. Chemical application of group theory by F. A Cotton
2. Shriver and Atkin's inorganic chemistry fifth edition.
3. Physical chemistry by P. Atkins and J. D. Paula, Ninth edition

---

# Unit - 5 : Molecular Orbital Theory (MOT)

---

## Structure of Unit

- 5.0 Objectives
- 5.1 Introduction
- 5.2 Molecular Orbital Theory (MOT)
- 5.3 Basic Principles of MOT
- 5.4 Relative order of the energy of  $\psi_A$ ,  $\psi_B$ ,  $\psi_b$  and  $\psi_a$
- 5.5 Energy Level Diagram for Molecular Orbitals
- 5.6 Molecular Orbital Configuration of some Homonuclear Diatomic Molecules
- 5.7 Molecular Orbital Configuration of some Hetero Nuclear Diatomic Molecules
- 5.8 MO's of AB<sub>4</sub> type
- 5.9 Summary
- 5.10 Review Questions
- 5.11 References and Suggested Readings

## 5.0 Objectives

---

- This unit is being added in the paper so that one can know about the molecular orbital theory. In this unit following topics are try to cover:
- What are the basic principles of molecular orbital theory?
- Various energy level diagrams for molecular orbitals
- Molecular orbital diagrams of various types of molecules

## 5.1 Introduction

---

In chemistry, molecular orbital (MO) theory is a method for determining molecular structure in which electrons are not assigned to individual bonds between atoms, but are treated as moving under the influence of the nuclei in the whole molecule. Because electrons are the fundamental constituents of matter involved in bonding,

their involvement in bonding has been studied exhaustively by chemists. Electrons are shared among individual atoms in a molecule to form covalent chemical bonds. Generally, up to three bonds can form between atoms in a molecule. Single, or sigma covalent bonds result from the interaction between the nuclei of two discrete atoms; multiple bonds then can result due to the additional formation of pi bonds between overlapping orbitals of like symmetries. Electrons in sigma bonds are located between the nuclei, while electrons in pi bonds are delocalized in regions above and below the nuclei.

The spatial and energetic properties of electrons within atoms are fixed by quantum mechanics to form orbitals that contain these electrons. While atomic orbitals contain electrons ascribed to a single atom, molecular orbitals, which surround a number of atoms in a molecule, contain valence electrons between atoms. Molecular orbital theory, which was proposed in the early twentieth century, revolutionized the study of bonding by approximating the positions of bonded electrons—the molecular orbitals—as Linear Combinations of Atomic Orbitals (LCAO). These approximations are made by applying the Density Functional Theory (DFT) and Hartree–Fock (HF) models to the Schrödinger equation.

MO theory applies the wavelike behavior of electrons as predicted by quantum mechanics, in that electrons no longer deterministically are given defined coordinates, but rather are given probable locations according to the mathematical wavefunctions defining all the possible positions of the electrons. These wavefunctions, or electron eigenstates, quantitatively describe the atomic orbital basis in which an electron temporarily can reside.

---

## **5.2 Molecular Orbital Theory (MOT)**

---

Hund and Mulliken have developed an approach to bond formation which is based upon the effects of the various electron field upon each other and which employs molecular orbital rather than atomic orbitals. Each such orbital characterizing the molecule as a whole is described by a definite combination of quantum numbers and possesses a relative energy value.

According to this theory the atomic orbitals combine and form a resultant orbital known as the molecular orbital in which the identity of both the atomic orbitals is lost. All the electrons pertaining to both the atoms are considered to be moving along the entire molecule under the influence of all the nuclei.

This may be illustrated by the following figure.

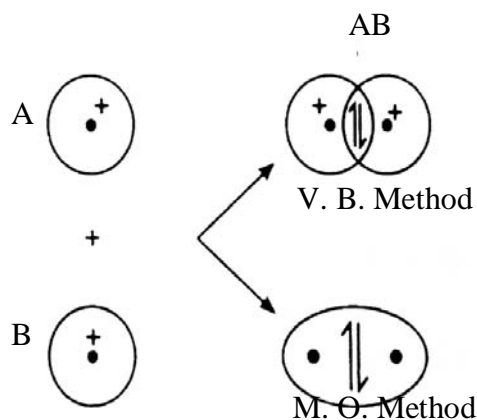

Figure: Formation of molecular orbital by valence bond method and molecular orbital method

---

### 5.3 Basic Principles of MOT

---

1. When nuclei of two atoms come close to each other, their atomic orbitals interact resulting in the formation of molecular orbitals (M.O.). In molecule atomic orbitals of atoms lose their identity after the formation of molecular orbitals.
2. Each M.O. may be described by the wave function  $\Psi$ , which is known as M.O. wave function.  $\Psi^2$  represents the probability density or electron density.
3. Each M.O. wave function ( $w$ ) is associated with a set of quantum number which represents the energy and shape of the occupied M.O.
4. Each  $\Psi$  is associated with a definite energy value. The total energy of the molecule is the sum of the energies of the occupied M.O.

5. Electrons tend to fill the M.O. in the same way, as they filled in the atomic orbitals following the Aufbau principle, Hund's rule and Pauli's exclusion principle.
6. Each electron in a M.O. belongs to all the nuclei present in the molecule.
7. Each electron moving in the M.O. is having clockwise or anticlockwise (i.e.  $+1/2$  or  $-1/2$ ) spin.

### Salient Features of Molecular Orbital Theory

When two isolated atomic orbitals (A.Os.) (or their wave function) of two atoms having similar energy and symmetry combine linearly combination of atomic orbital (LCAO) method (described below) two M.Os. are obtained. If both the atoms are of the same element that is called homo-nuclear diatomic molecule or ion (e.g.  $H_2$ ,  $H_2^+$ ,  $H_2^-$ ,  $N_2$ ,  $O_2$ ,  $O_2^+$ ,  $O_2^-$  etc.). If both the atoms are of the different elements, that is called hetero-nuclear diatomic molecule or ion (e.g. CO, NO, HF,  $CN^-$ ,  $NO^+$ ,  $NO^-$  etc.)

When three A.Os. of similar energy and same symmetry combine with one another, three M.Os. are obtained. Therefore it may be concluded that number of M.O.s obtained is always equal to number of A.Os. combining together.



Figura: Representation of an electron wave

(ii) Linear Combination of Atomic Orbitals (LCAO): The molecular orbitals can be obtained by the method of LCAO. Let two atoms A and B form AB molecule (hetero-diatomic molecule). Their A.Os. are represented by  $\Psi_A$  and  $\Psi_B$  respectively. There are following two ways of their combination.

(a) Additive overlap: It is also known as positive overlap or ++ overlap. In this type of linear combination, the positive lobe (i.e. the lobe having + sign) of  $\Psi_A$  overlaps with the positive lobe of  $\Psi_B$  thus a molecular orbital is formed. This molecular orbital has lower energy than that of atomic orbitals of atoms A and B due to attraction between the nuclei of A and B. Such type of molecular orbitals are known as bonding molecular orbitals (BMO) and represented as  $\Psi^b$ .

(b) Subtractive overlap : It is also known as negative overlap or + - overlap. In this type of linear combination, the positive lobe of  $\Psi_A$  overlaps with the negative lobe (i.e. the lobe having negative (-) sign) of  $\Psi_B$  thus a molecular orbital is formed. This molecular orbital has higher energy than that of atomic orbitals of atoms A and B due to repulsion between the nuclei of A and B. Such type of molecular orbitals are known as anti bonding molecular orbitals (ABMO) and represented as  $\Psi^a$  or  $\Psi^*$ .

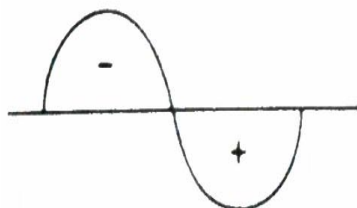
On the basis of above discussion, the formation of BMO and ABMO by the linear combination of  $\Psi_A$  and  $\Psi_B$  may be represented as:

$$\Psi^b = \Psi_A + \Psi_B \text{ (+ + overlap) } \dots\dots\dots(1)$$

$$\Psi^a = \Psi_A - \Psi_B \text{ (+ - overlap) } \dots\dots\dots(2)$$

when we show the contribution made by  $\Psi_A$  and  $\Psi_B$  in  $\Psi^b$  and  $\Psi^a$  molecular orbitals the above equations may be written as:

$$\Psi^b = \frac{1}{\sqrt{2}} (\Psi_A + \Psi_B)$$

$$\Psi^a = \frac{1}{\sqrt{2}} (\Psi_A - \Psi_B)$$

The relative order of the energy of  $\Psi_A$ ,  $\Psi_B$ ,  $\Psi^b$  and  $\Psi^a$  may be shown pictorially as follows:

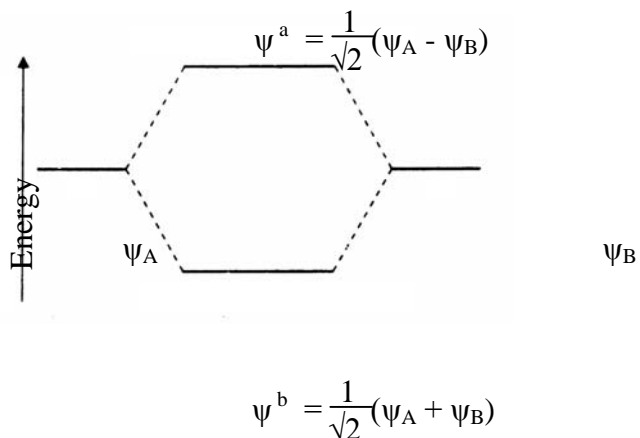

Figure: Relative order of the energy  $\psi_A$ ,  $\psi_B$ ,  $\psi^b$  and  $\psi^a$ .

---

### 5.4 Relative order of the energy of $\psi_A$ , $\psi_B$ , $\psi^b$ and $\psi^a$

---

It is to be noted that in the case of bonding orbital electron density is concentrated between the two nuclei of the two atoms. While in the case of anti bonding orbital nuclei of the two atoms come close to each other due to same charge and absence of the electron density, the nuclei repel each other. We know that square of the wave function ( $\Psi^2$ ) is known as probability of finding the electrons hence we square the eq. (1) and (2) we get

$$(\psi^b)^2 = \psi_A^2 + \psi_B^2 + 2 \psi_A \psi_B \dots\dots\dots(3)$$

$$(\psi^a)^2 = \psi_A^2 + \psi_B^2 - 2 \psi_A \psi_B \dots\dots\dots(4)$$

It is clear from eq. (3) that the value of  $(\psi^b)^2$  is greater than the sum of  $\psi_A^2$  and  $\psi_B^2$ . It means that the probability of finding the electrons in the MOs obtained by the linear combination in accordance with eq. (1) is greater than that in either of the AOs  $\psi_A$  and  $\psi_B$ . In other words the energy of  $\psi^b$  is lower than either of  $\psi_A$  and  $\psi_B$ . Hence this orbital forms stable chemical bond and named as bonding molecular orbital.

In the same way we can say that from eq. (4) that the value of  $(\Psi^a)^2$  is lesser than  $\Psi_A^2 + \Psi_B^2$ . It means that the probability of finding the electron in the MOs obtained by the linear combination in accordance with eq. (2) is lesser than that in either of the AOs  $\Psi_A$  and  $\Psi_B$ . In other words the energy of  $\Psi^b$  is higher than either of  $\Psi_A$  and  $\Psi_B$ . Hence this orbital cannot form a stable chemical bond and is named as anti-bonding molecular orbital.

The physical pictures of these MOs are shown in figure on next page. In the picture dotted lines are shown for isolated A.Os. [ $\Psi_A^2$  and  $\Psi_B^2$ ] while solid lines are shown for BMO (in figure, a) and ABMO (in figure, b). In figure, (a) it is clear that in BMO the electron charge density or probability of finding an electron is maximum in the region lying between the nuclei of A and B atoms. In other words

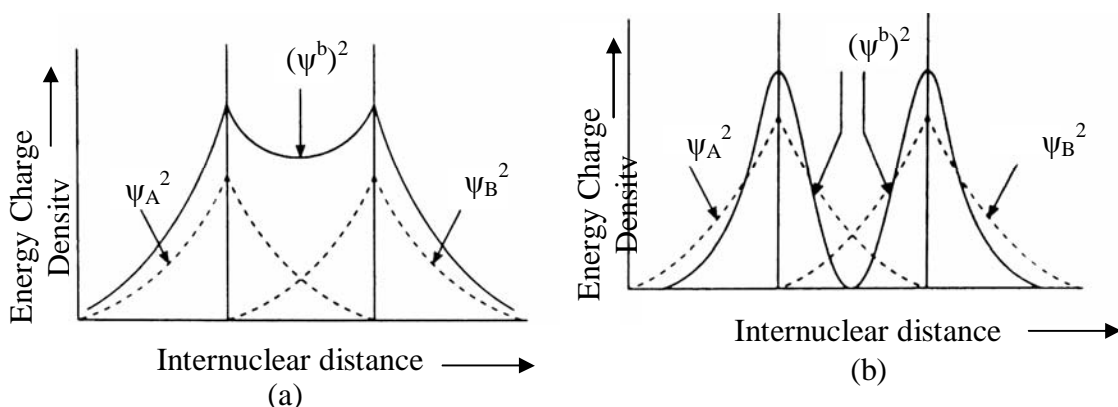

it is a stable bond between atoms A and B. In figure, (b), it is clear that in ABMO the electron density or probability of finding the electron is minimum in the region lying between the nuclei of A and B atoms. Since the two nuclei repel each other hence no bond is formed. The middle point in which the electron charge density is zero is known as node point or the plane is called nodal plane.

#### Pictorial Representation of Combination of Atomic Orbitals to form Molecular

Orbitals : Here we discuss the combination of different atomic orbitals s- and p-orbitals as follows:

(i) Combination of s-orbitals: When two s-orbitals overlap with each other we get two molecular orbitals known as BMO and ABMO. Obviously first one is due to



additive combination (or + + overlap) and second one is due to subtractive combination (or + - overlap). In + + overlap the electron charge density in the region between the two nuclei would get intensified.

Thus high charge density in between the two nuclei shields them from mutual repulsion and holds them together at the observed distance from each other while in + — overlap the electron charge density would get removed from the middle of the two nuclei. Thus there will be no shielding of the nuclei or repulsion between two nuclei would be increased thereby increasing the energy of the molecular orbital formed.

If is atomic orbitals overlap with each other, the BMO is represented as  $\sigma$  (is) orbital. The sign  $\sigma$  signifies that the orbital is symmetrical about the molecular axis and the script (is) indicates that it is formed by the combination of is atomic orbitals, while ABMO is designated as  $\sigma^*$  (1s).

In the same way if 2s or 3s atomic orbitals combine to form BMO and ABMO. these will be designated by a  $\sigma$  (2s) and  $\sigma^*$  (2s) or  $\sigma$  (3s) and  $\sigma^*$  (3s).

The formation of  $\sigma$  (s) and  $\sigma^*$  (s) molecular orbitals are shown in the following figure.

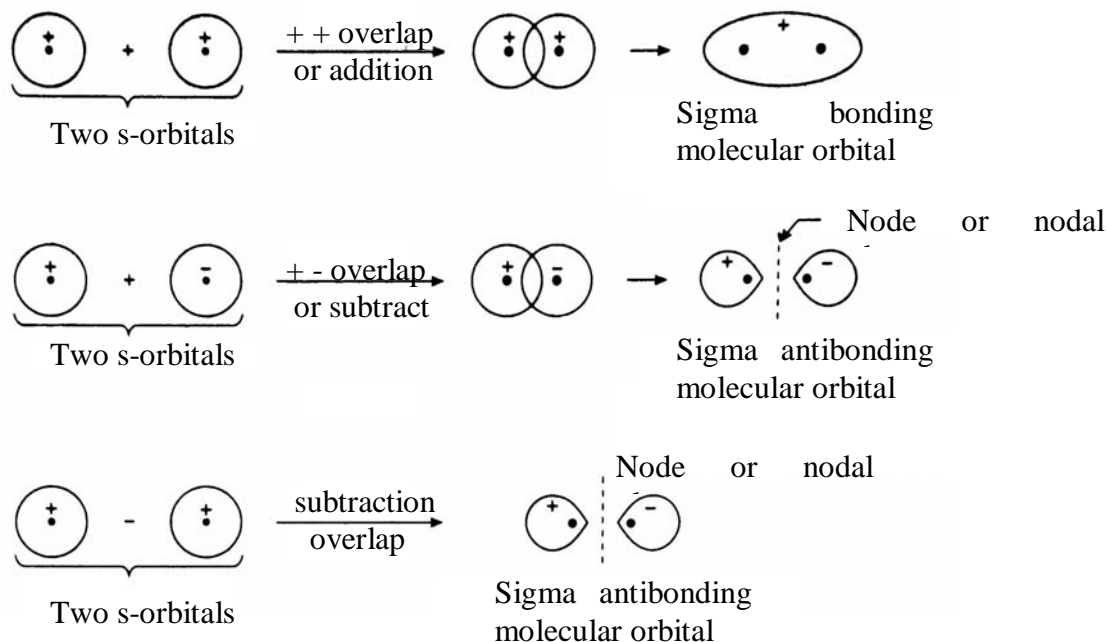

Figure: Formation of  $\sigma(2s)$  and  $\sigma^*(2s)$  molecular orbital by  $++$  and  $+ -$  overlapping.

(ii) Combination of p-orbitals: There are three p-orbitals ( $p_x$ ,  $p_y$ , and  $p_z$ ) in p-subshell. These can overlap and be combined either end to end to give  $\sigma$ -molecular orbitals or side to side to give  $\pi$ -molecular orbitals. Here both types of combinations are described.

(a) Combination of p orbitals: Let x-axis be the molecular axis. Therefore when two atomic orbitals overlap on x-axis, then two sigma molecular orbitals are formed.

One of these is sigma BMO [i.e.  $\sigma(p_x)$ ] having lower energy (due to  $++$  overlap) than that of  $p_x$ -atomic orbitals and the other is sigma ABMO [i.e.  $\sigma^*(p_x)$ ] having higher energy (due to  $+ -$  overlap) than that of  $p_x$ -atomic orbitals. The sigma  $\sigma^*$ ,  $p_x$  etc. signifies as above. The formation of these molecular orbitals is shown in the following figure.

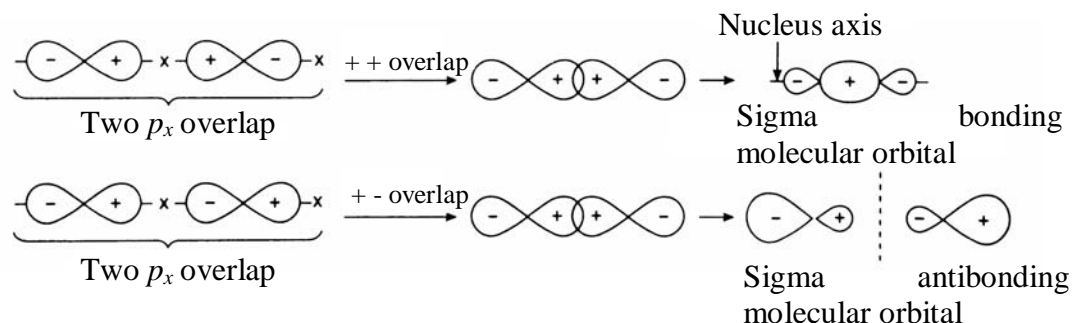
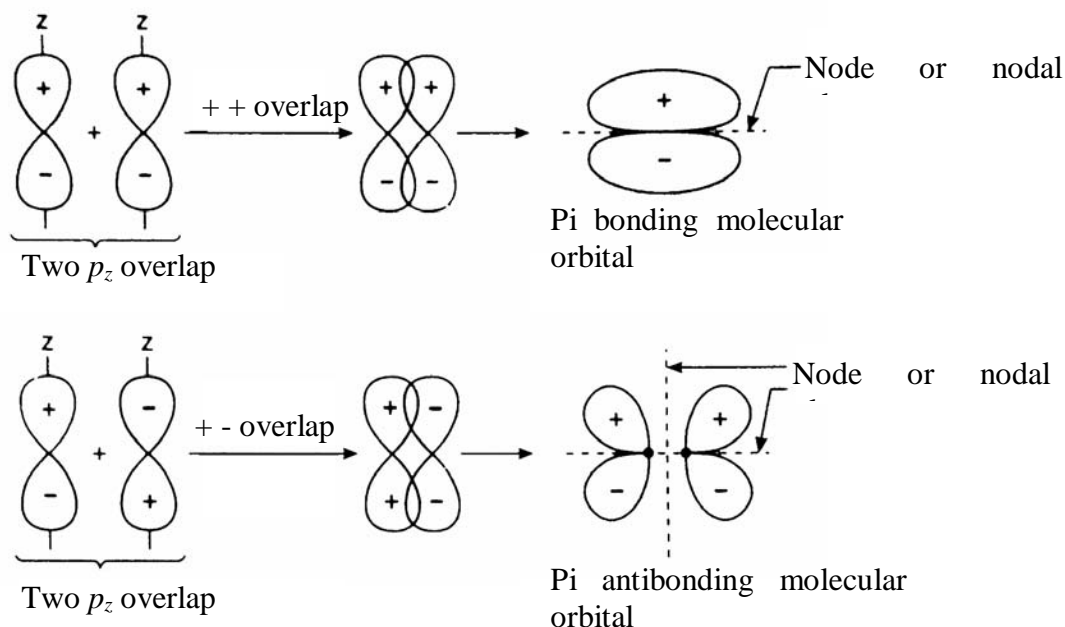

Figure: Formation of  $\sigma(2s)$  and  $\sigma^*(2s)$  molecular orbital by  $++$  and  $+ -$  overlapping.

It may be noted that the overlap between two s-orbitals; s and one  $p_x$  orbital and two  $p_x$  orbitals along the molecular axis is called as head-to-head, head-on, end-on or linear overlap.

(b) Combination of  $p_y$ , or  $p_z$  orbitals : Since x-axis is considered as molecular axis hence y- and z-axes are perpendicular to molecular axis. When two  $p_y$  or  $p_z$  orbitals overlap together along the molecular axis (i.e. x-axis) two pi molecular orbitals are formed. One of these is pi BMO [i.e.  $\Pi(p_y)$  or  $\Pi(p_z)$ ] having lower energy (due to ++ overlap) than that of  $p_y$  or  $p_z$  atomic orbitals and the other is pi ABMO [i.e.  $\Pi^*$



( $p_y$ ) or  $\Pi^*(p_z)$ ] having higher energy (due to + - overlap). The sign  $\Pi^*$ ,  $p_y$  or  $p_z$  etc. signifies as above. The formation of these molecular orbitals is shown in the following figure.

Figure: Formation of  $\Pi(p_z)$  and  $\Pi^*(p_z)$  molecular orbital by ++ and +- overlapping.

Similarly we can show the formation of  $\Pi(p_y)$  and  $\Pi^*(p_y)$  pi molecular orbitals.

(iii) Combination of s- and p-orbitals : Since x-axis is considered as molecular axis hence when one s- and one p-orbital overlap on x-axis two molecular orbitals are formed one of these is sigma BMO [i.e.  $\Sigma(sp)$ ] having lower energy (due to ++ overlap) than s- and p-orbitals involved in overlapping and the other is sigma ABMO [i.e.  $\Sigma^*(sp)$ ] having higher energy (due to + - overlap) than s- and p-

orbitals involved in overlapping. The formation of these molecular orbitals is shown in the following figure.

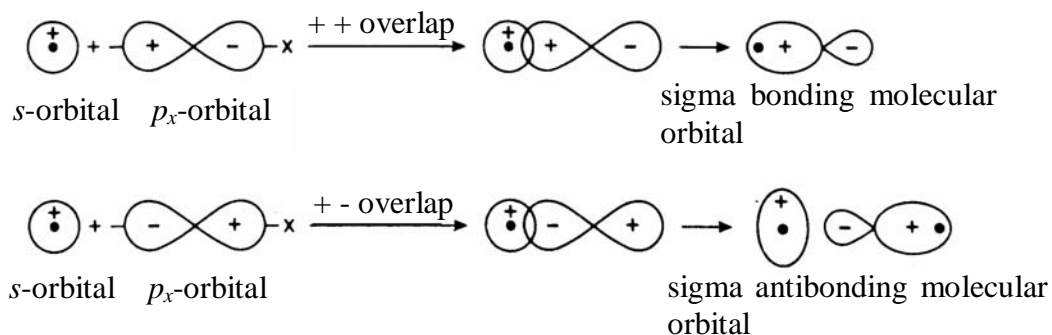

Figure: Formation of  $\sigma(sp)$  and  $\sigma^*(sp)$  molecular orbital by + + and + - overlapping of one *s* and one *p* orbital.

### Conditions for the Combination of Atomic Orbitals

It is important to note that any two atomic orbitals will not essentially combine to form molecular orbitals. Actually there are certain limitations to combine the atomic orbitals. These are as follows

- (i) The energy of the combining atomic orbitals should be same or almost same: Therefore in the formation of homonuclear diatomic molecule such as A<sub>2</sub>, 1s-1s, 2s-2s overlap is possible but 1s-2s or 1s-2p overlap is not possible due to difference in energy of the atomic orbitals of the same element. However in the case of heteronuclear diatomic molecule such as AB this type of overlap may be possible.
- (ii) The combination of atomic orbitals is possible only if overlap takes place upto considerable extent: Because such type of overlap increases electron density between the two nuclei which minimize their mutual repulsion and bond becomes stronger.
- (iii) The atomic orbitals should have the same symmetry about the molecular axis: In other words if two atomic orbitals are of same or almost same energy, they will not combine with each other if they do not have same

symmetry. On this basis we can say that  $s$ - $s$ ,  $s$ - $p_x$ ,  $p_x$ - $p_x$ ,  $p_y$ - $p_y$  and  $p_z$ - $p_x$  combinations are possible. But  $s$ - $p_y$ ,  $p_x$ - $p_y$  and  $p_x$ - $p_z$  type combinations are not possible. Because in these types of overlap  $+$   $+$  overlap region is cancelled by  $+$   $-$  overlap region, therefore no molecular orbital is formed (non-bonding molecular orbital). This idea may be shown by the following figures.

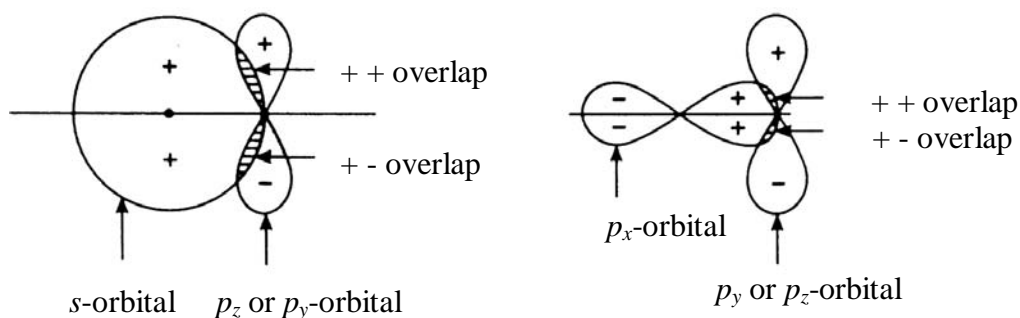

(a)  $s$ - $p_y$  or  $s$ - $p_z$  overlap

(a)  $p_x$ - $p_y$  or  $p_x$ - $p_z$  overlap

Figure: Limitation of overlap of atomic orbital of different symmetry.

**Bond order:** The bond order (B.O.) in diatomic molecules is half of the difference between the total number of the bonding electron ( $N_b$ ) and antibonding electrons ( $N_a$ ). Therefore

As the bond order increases stability of the bond increases and bond length decreases.

If bond order is zero, the molecule does not exist. If bond order is 0.5, the atoms of the molecule are linked by one electron only e.g.,  $H_2^+$  it may be written as  $[H \cdot H]^+$ . The bond order of  $H_2^-$  and  $He_2^+$  is also 0.5, but in this case there are three electrons therefore they may be represented as  $[H \dots H]^-$  and  $[He \dots He]^+$  respectively. If bond order is 1.5 or 2.5 it indicates that one bond is formed by three electrons e.g.,  $O_2^-$  (B.O. 1.5). The ions  $N_2^+$  and  $O_2^+$  both have B.O. 2.5

**Magnetic Properties:** The species (molecule or ion) which have unpaired electrons are paramagnetic while those have paired electrons are diamagnetic. The magnetic moment ( $\mu_{\text{eff}}$ ) related with number of unpaired electrons as

$$\mu_{\text{eff}} = \sqrt{n(n+2)} \text{ B. M.}$$

where n is number of unpaired electrons.

## 5.5 Energy Level Diagram for Molecular Orbitals

The energy level of these orbitals have been determined experimentally from spectroscopic data. The order of their increasing energy is given below and shown in the figure.

$$\sigma(1s) < \sigma^*(1s) < \sigma(2s) < \sigma^*(2s) < \sigma(2p_z) < \pi(2p_y) = \pi(2p_x) < \pi^*(2p_x) = \pi^*(2p_y) < \sigma^*(2p_z)$$

The electrons in the molecular orbitals are filled in this order.

It is observed that for some elements (Li, Be, B, C and N) the above energy level is not correct. For these elements the energy level of  $\sigma(2p_z)$  MO is higher than it  $\pi(2p_z)$  or it  $\pi(2p_x)$  MOs. This is due to the mixing of  $2s$  and  $2p_z$  AOs as discussed below.

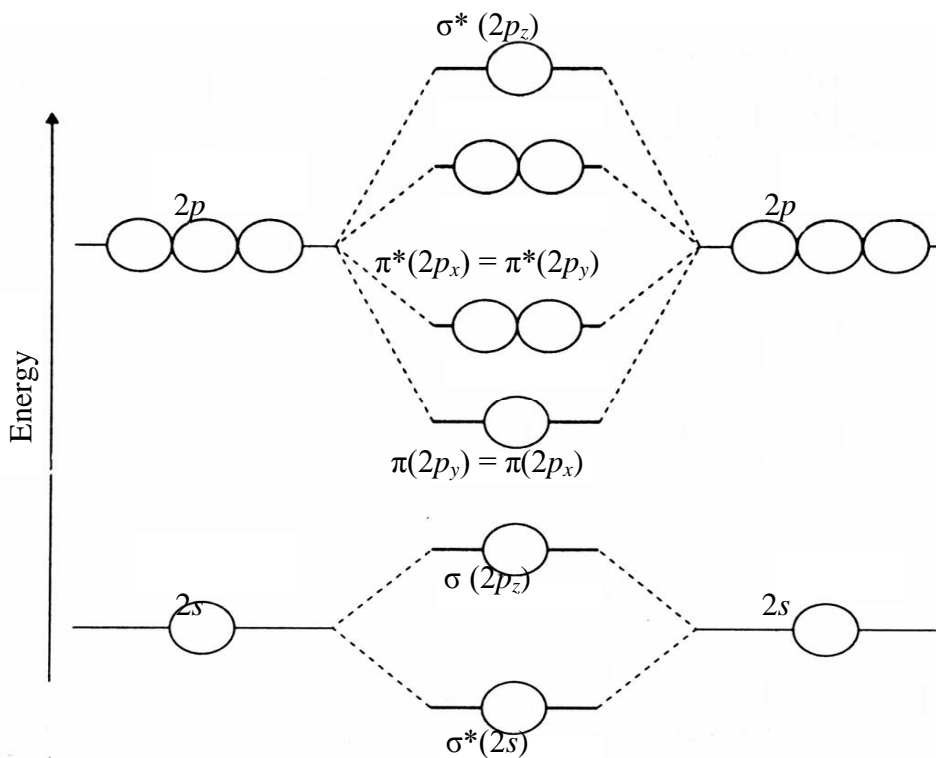

**Mixing of Orbitals :** We know that due to the combination of  $2s$  AOs of two atoms  $\sigma(2s)$  and  $\sigma^*(2s)$  MOs are formed. In the same way by the combination of  $2p_z$  AOs of two atoms  $\sigma(2p_z)$  and  $\sigma^*(2p_z)$  are formed. But if the difference between  $2s$  and  $2p$  AOs is smaller, then there is possibility of the mixing of  $2s$  and  $2p_z$  AOs to acquire  $sp$  character. Under this condition neither  $\sigma(2s)$  and  $\sigma^*(2s)$  MOs retain pure  $s$  character nor  $\sigma(2p_z)$  and  $\sigma^*(2p_z)$  MOs retain pure  $p$  character. Due to this  $s$ - $p$  mixing the energies of these four MOs change in such a way that  $\sigma(2s)$  and  $\sigma^*(2s)$  become more stable (attain lower energy level) and  $\sigma(2p_z)$  and  $\sigma^*(2p_z)$  become less stable (attain higher energy level) as shown in next page. Because  $\pi(p)$  orbitals are not involved in mixing therefore their energy levels remain unchanged as shown in the figure. Due to this fact a new sequence of energy of MOs is obtained, which is given below:

$$\sigma(1s) < \sigma^*(1s) < \sigma(2s) < \sigma^*(2s) < \pi(2p_x) = \pi(2p_y) < \sigma(2p_z) < \pi^*(2p_x) = \pi^*(2p_y) < \sigma^*(2p_z)$$

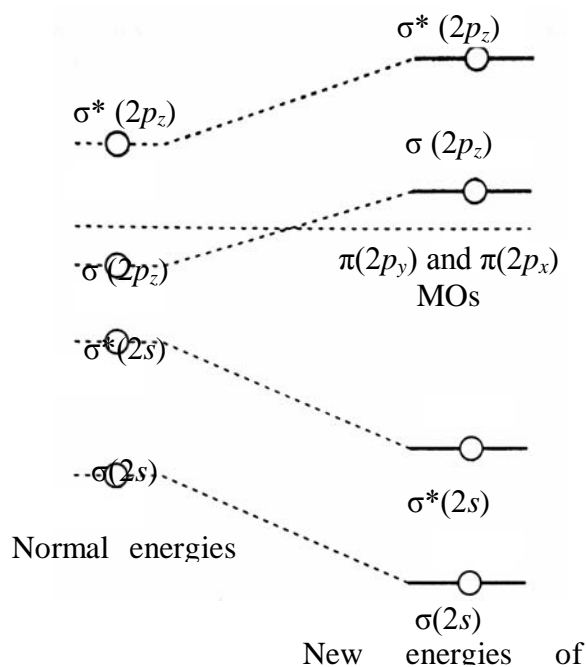

Figure: Change in energy level of MOs during the mixing of  $s$  and  $p_z$  AOs.

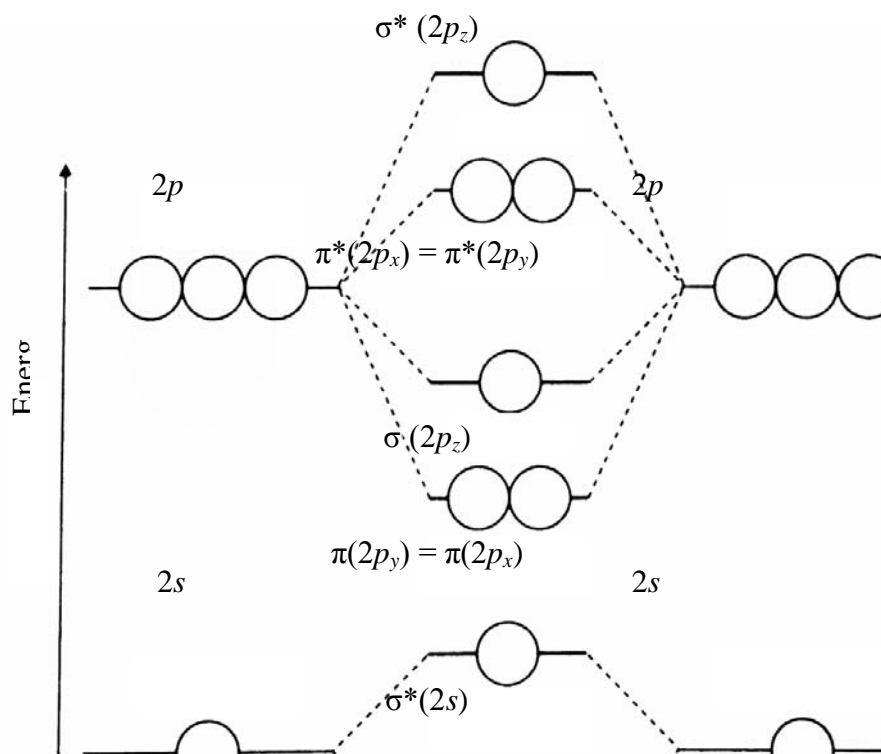

Figure: energy levels of different MOs resulting from the mixing of  $s$  and  $p_z$  AOs.

It is very important to note that the above sequence of the energy level is for Li, Be, B, C, N atoms. The reason is that the difference in energy levels between  $2s$  and  $2p_z$  AOs for these atoms is lower while that for O and F is very large as reported in the following table.

Atoms	Li	Be	B	C	N	O	F
Difference between energies of $2p_z$ AOs (kJ/mol)	178	262	449	510	570	1430	1970



## 5.6 Molecular Orbital Configuration of some Homonuclear Diatomic Molecules

Now we describe the MOs configuration of some homonuclear diatomic molecules and explain their properties specially with respect to bond energy, bond length, magnetic character etc.

**1. Hydrogen molecule (H<sub>2</sub>):** The electronic configuration of hydrogen atom is 1s<sup>1</sup>. When hydrogen molecule is formed by the combination of two hydrogen atoms we have two electrons of same energy which occupy a (1s) MO. According to Pauli's exclusion principle these two electrons should have opposite spin. Thus MO configuration of H<sub>2</sub> may be presented as below:

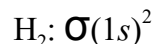

Since there are only two bonding electrons hence the bond order =  $\frac{1}{2} (2 - 0) = 1$ . It means here is a single bond in hydrogen molecule. The bond dissociation energy of H<sub>2</sub> molecule has been found to be 458 kJ/mol and bond length is 0.74 Å.

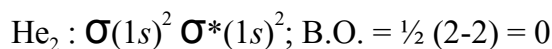
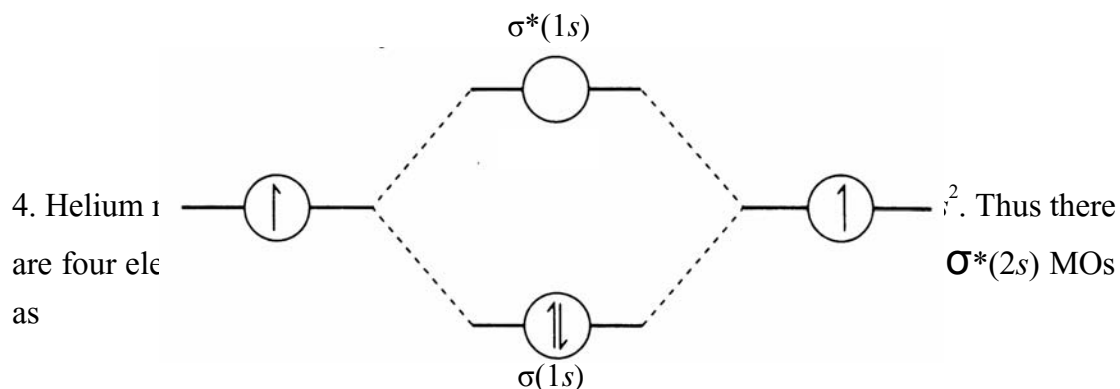

Because in this case bond order is zero therefore He<sub>2</sub> molecule does not exist.

**5. Lithium molecule (Li<sub>2</sub>):** The electronic configuration of lithium is 1s<sup>2</sup> 2s<sup>1</sup>. Thus in Li<sub>2</sub> molecule there are six electrons out of which four electrons belong to K

shells and only two electrons are to be distributed in MOs. Thus MO configuration of  $\text{Li}_2$  is as

$$\text{Li}_2 : K K \sigma(2s^2); \text{B.O.} = \frac{1}{2} (2-0) = 1$$

it means  $\text{Li}_2$  molecule exists and there is single bond (Li—Li) in lithium molecule. The bond energy of  $\text{Li}_2$  molecule is low (105 kJ/mol) and its bond length is large (2.67 Å).

Now the question is, why the bond energy of  $\text{Li}_2$  is quite lower than that of  $\text{H}_2$  or the bond length of  $\text{Li}_2$  is quite larger than that of  $\text{H}_2$ . The reason is that, in the case of  $\text{Li}_2$  molecule 2s AOs overlap which is less effective than the overlapping of 1s-1s AOs. At the same time due to the presence of inner 1s orbitals  $\sigma(2s)$  MO is shielded by these orbitals. Hence the attraction between the nuclei and the electrons in  $\sigma(2s)$  MO is less.

6. Beryllium molecule ( $\text{Be}_2$ ) : The electronic configuration of beryllium is  $1s^2 2s^2$ . It means there are eight electrons in proposed  $\text{Be}_2$  molecule out of which four electrons belong to K-shells and four electrons are distributed in  $\sigma(2s)$  and  $\sigma^*(2s)$  MOs. Thus the MO configuration of  $\text{Be}_2$  is as

$$\text{Be}_2 = K K \sigma(2s^2) K K \sigma^*(2s^2); \text{B.O.} = \frac{1}{2} (2-2) = 0$$

Because in this case bond order is zero therefore  $\text{Be}_2$  molecule does not exist.

7. Boron molecule ( $\text{B}_2$ ) : The electronic configuration of boron is  $1s^2 2s^2 2p^2$ . It means there are ten electrons in  $\text{B}_2$  molecule, out of which four electrons belong to K-shells and six electrons are distributed as  $\sigma(2s)$ ,  $\sigma^*(2s)$ ,  $\pi(2p_x)^1$  and  $\pi(2p_y)^1$  MOs. Thus the MO configuration of  $\text{B}_2$  is as

$$\text{B}_2 = K K \sigma(2s^2) \sigma^*(2s^2) \pi(2p_x)^1 \pi(2p_y)^1$$

$$\text{B.O.} = \frac{1}{2} (4-2) = 1$$

Since there are two unpaired electrons in the  $\text{B}_2$  molecules hence it is paramagnetic in nature as expected. It is interesting to note that if we distribute the electrons in different MOs then MO configuration becomes  $K K \sigma(2s^2) \sigma^*(2s^2) \pi(2p_z)^2$ . Since in this case there is no unpaired electron hence the  $\text{B}_2$  molecule

should be diamagnetic but it is not so. Therefore we can say that mixing of orbitals ( $2s$  and  $2p$ ) takes place, where the difference in energy level between  $2s$  and  $2p$  is smaller (e.g.  $\text{Li}_2$ ,  $\text{Be}_2$ ,  $\text{B}_2$ ,  $\text{C}_2$ ,  $\text{N}_2$ ).

The bond dissociation energy and bond length of  $\text{B}_2$  molecule have been found to be  $289 \text{ kJ/mol}$  and  $1.59 \text{ \AA}$  respectively.

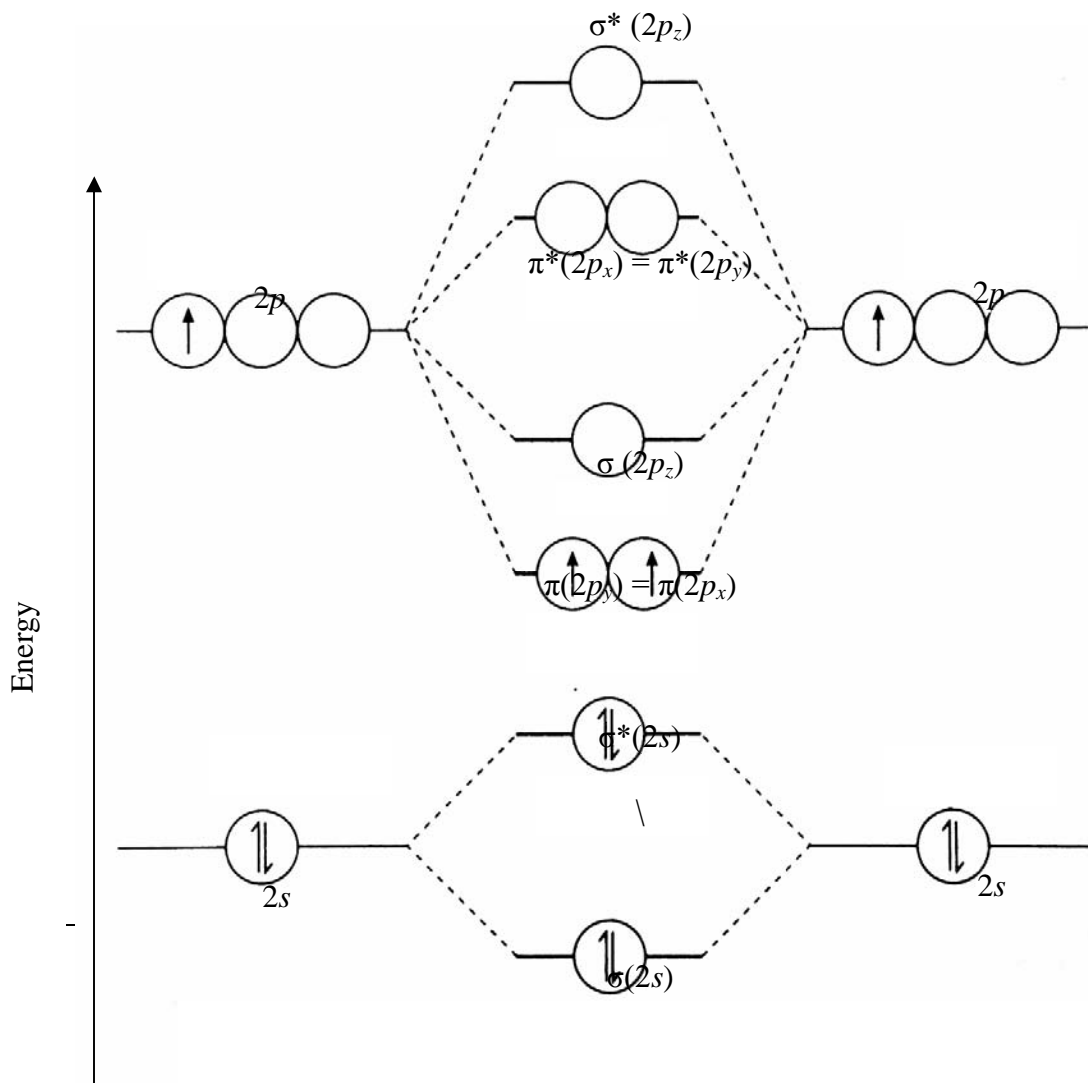

### 5.7 Molecular Orbital Configuration of some Hetero Nuclear Diatomic Molecules

$\text{B}_2$

B

in heteronuclear diatomic molecules the electronegativity of two atoms is different. Therefore the molecular orbital diagram will not be symmetrical like homonuclear diatomic molecules. But the method of distribution of electron is the same. In heteronuclear diatomic molecules the electrons in bonding MO spend more time near (or closer) the more electronegative atom whereas the electrons in antibonding MO spend more time near (or closer) the less electronegative atom. The formation of  $\Psi^b$  and  $\Psi^a$  (bonding and antibonding MOs ) from two AOs having different energies is shown in following figure.

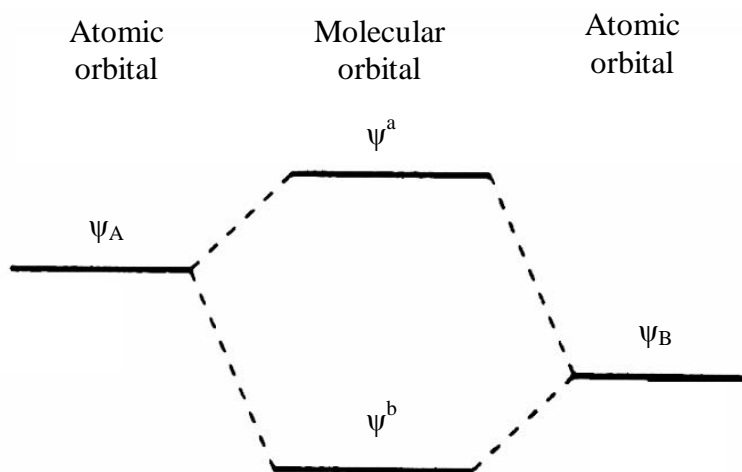

Figure: Formation of bonding and antibonding MO for two AOs of different energies.

Since the two atoms A and B belong to different elements hence they have different electronegativities. Let B be more electronegative than A therefore energy level of B is shown lower in the molecular orbital diagram. While energy level of A is shown higher in the molecular orbital diagram. This is the reason that BMOs receive more contribution from atomic orbitals of atom B and hence will be closer to this atom in energy. On the other hand ABMOs will be closer to atom A. A molecular orbital diagram for such molecules is shown here.

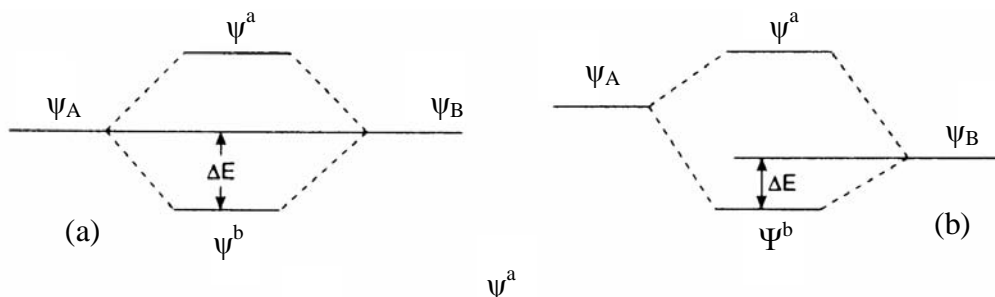

Figure: Relative energy level diagram AOs and MOs for hetero nuclear diatomic molecules.

The basic conditions to combine the different atomic orbitals of hetero nuclear diatomic molecules are the same as for homo nuclear diatomic molecule or ion, such as

- (i) Only atomic orbitals of almost same energy level can combine effectively to form molecular orbitals.
- (ii) There should be maximum overlap of the atomic orbitals.
- (iii) The atomic orbitals must have same symmetry.

Now we describe molecular orbital diagrams of some hetero nuclear diatomic molecules/ions.

**Nitric Oxide molecule (NO) :** The electronic configuration of nitrogen and oxygen atoms is  $1s^2 2s^2 2p^3$  and  $1s^2 2s^2 2p^4$  respectively. As in the above case only 11 electrons are to be adjusted in different MOs. These electrons are distributed as

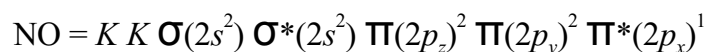

$$\text{B.O.} = \frac{1}{2} (8-3) = 2.5$$

This shows that in NO molecule there are one a and two it bonds less the antibonding effect of one unpaired electron [ $\pi^*(2p)$ ]. Due to the presence of one unpaired electron NO molecule is paramagnetic.

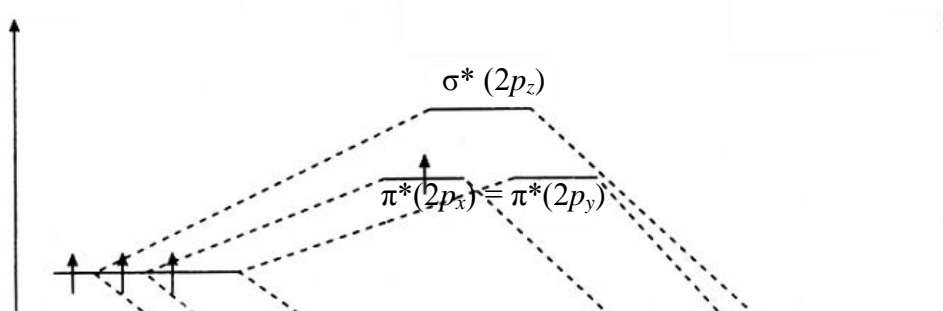

Figure: MO energy level diagram of NO molecule.

If we compare the stability of NO molecule with  $N_2$  and  $O_2$  molecules, we find that in NO molecule there is one electron extra in antibonding orbital as compared to  $N_2$  molecule therefore NO molecule is less stable (bond energy 667.8 kJ/mol) than  $N_2$  molecule (bond energy 945.9 kJ/mol). Similarly we can prove that NO molecule is more stable than  $O_2$  molecule (bond energy 494.6 kJ/mol).

Evidently the bond order (B.O.) for  $NO^+$ ,  $NO^{2+}$  and  $NO^-$  is 3, 2.5 and 2 respectively. Since B.O. is decreasing as  $NO^+ > NO^{2+} > NO^-$  hence bond energy is decreasing as  $NO^+ > NO^{2+} > NO^-$  and bond length is increasing as  $NO^+ < NO^{2+} < NO^-$ .  $NO^+$  cation does not possess unpaired electrons hence it is diamagnetic while  $NO^{2+}$  and  $NO^-$  ions are paramagnetic due to the presence of unpaired electrons.

---

## 5.8 MO's of AB4 type

---

Methane (CH<sub>4</sub>) : The CH<sub>4</sub> molecule has T<sub>d</sub> symmetry. Since there is relationship between a tetrahedron and cube that hence the T<sub>d</sub> point group belongs to the cubic point group family. Under T<sub>d</sub> symmetry, the orbitals of the C atom in CH<sub>4</sub> are classified as follows:

- the 2s orbital has a<sub>1</sub> symmetry;
- the 2p<sub>x</sub>, 2p<sub>y</sub> and 2p<sub>z</sub> orbitals are degenerate and the orbital set has t<sub>2</sub> symmetry.

In order to construct the LGOs of the H<sub>4</sub> fragment in CH<sub>4</sub>, we begin by working out the number of H 1s orbitals left unchanged by each symmetry operation of the T<sub>d</sub> point group. This results in the rows of characters for the A<sub>1</sub> and T<sub>2</sub> representations in the T<sub>d</sub> character table. The four ligand group orbitals therefore have a<sub>1</sub> and t<sub>2</sub> symmetries; the t label designates a triply degenerate set of orbitals. Normalized wavefunctions for these LGOs are given by equations

$$\Psi(a_1) = \frac{1}{2} (\Psi_1 + \Psi_2 + \Psi_3 + \Psi_4)$$

$$\Psi(t_2)_1 = \frac{1}{2} (\Psi_1 - \Psi_2 + \Psi_3 - \Psi_4)$$

$$\Psi(t_2)_2 = \frac{1}{2} (\Psi_1 + \Psi_2 - \Psi_3 - \Psi_4)$$

$$\Psi(t_2)_3 = \frac{1}{2} (\Psi_1 - \Psi_2 - \Psi_3 + \Psi_4)$$

the symmetries of the four ligand group orbitals can be readily matched to those of the 2s, 2p<sub>x</sub>, 2p<sub>y</sub> and 2p<sub>z</sub> atomic orbitals of the C atom. This allows us to construct a qualitative MO diagram in which the interactions between the carbon atomic orbitals and the ligand group orbitals of the H<sub>4</sub> fragment lead to four MOs with delocalized  $\sigma$ -bonding character and four antibonding MOs.

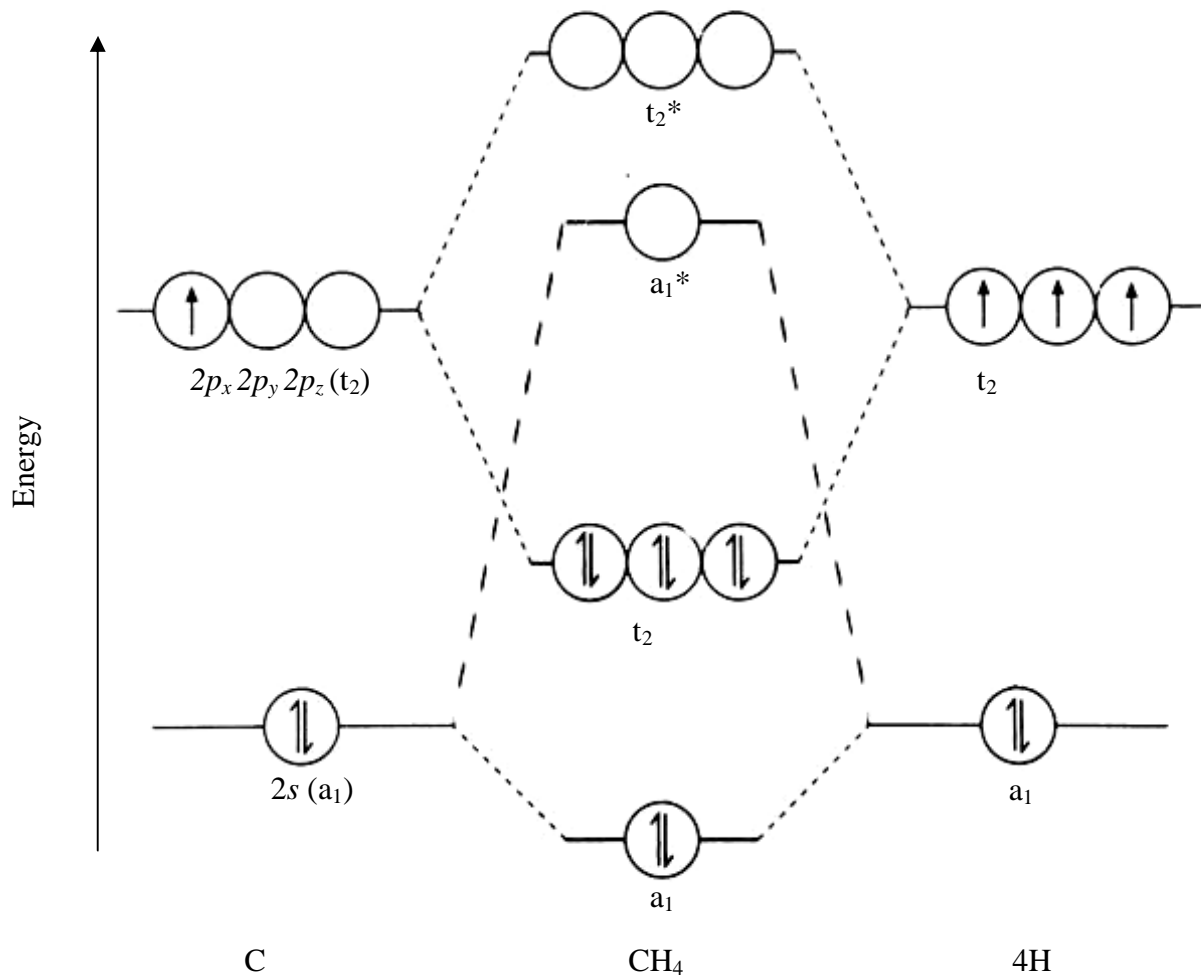

Figure: MO energy level diagram of CH<sub>4</sub> molecule.

---

## 5.9 Summary

---

In this unit following topics are discussed in details:

- What are the basic principles of molecular orbital theory?
- Various energy level diagrams for molecular orbitals



- Molecular orbital diagrams of various types of molecules

---

## 5.10 Review Questions

---

1. What are the basic principles of molecular orbital theory?
2. What are the conditions for the combination of atomic orbitals?
3. What is bond order?
4. Draw energy level diagram for molecular orbitals.
5. How atomic orbitals get mixed according to molecular orbital theory?
6. Calculate the bond order for  $H_2$ ,  $CO_2$  and  $He_2$  molecules.
7. Draw molecular orbital diagram for  $H_2$  molecule and discuss it.
8. Draw energy level diagram for hetero nuclear diatomic molecules.
9. Calculate the bond order for  $NO$  and  $NO^+$ .
10. Discuss molecular orbital theory for methane.

---

## 5.11 Glossary

---

1. MOT: molecular orbital theory is a method for determining molecular structure in which electrons are not assigned to individual bonds between atoms
2. Quantum mechanics: It, also known as quantum physics or quantum theory, is a branch of physics which deals with physical phenomena at nanoscopic scales where the action is on the order of the Planck constant.
3. Pi bond: pi bonds ( $\pi$  bonds) are covalent chemical bonds where two lobes of one involved atomic orbital overlap two lobes of the other involved atomic orbital.
4. Wave function: A wave function or wavefunction (also named a state function) in quantum mechanics describes the quantum state of a system of one or more particles, and contains all the information about the system.

5. Bond order: The bond order (B.O.) in diatomic molecules is half of the difference between the total number of the bonding electron ( $N_b$ ) and antibonding electrons ( $N_a$ )
6. Atomic orbital: An atomic orbital is a mathematical function that describes the wave-like behavior of either one electron or a pair of electrons in an atom.
7. Molecular orbital: a molecular orbital (or MO) is a mathematical function describing the wave-like behavior of an electron in a molecule.

---

## 5.12 References and Suggested Readings

---

1. Concise Inorganic chemistry- J.D. Lee (Blackwell Science) 2001
2. Inorganic Chemistry- F.A. Cotton (Interscience publisher) 2008
3. Inorganic chemistry, principles of structure and reactivity- James E. Huheey (Harper Collins college publishers) 1993
4. Inorganic chemistry- G Sharpe, (Pearson printice hall) 2005
5. Inorganic chemistry- James E. House (Elsevier academic press) 2008
6. [en.wikipedia.org/](http://en.wikipedia.org/)

---

## Unit – 6 : Crystallographic Symmetry

---

### Structure of Unit:

- 6.0. Objective
- 6.1. Introduction
- 6.2. Space lattice and unit cells
- 6.3. Crystal lattice
- 6.4. Glide plane on unit cell Space lattice
- 6.5. Screw axis
- 6.6. Crystallographic Axes
- 6.7. Crystal System
- 6.8. Bravais lattices
- 6.9. Miller indices
- 6.10. Stereographic projection
- 6.11. Summary
- 6.12. Review Questions
- 6.13. References and Suggested readings

---

### 6.0 Objective

---

At the end of the unit learner will be able to

- Understand the Skills of crystal lattice and space lattice
- Acknowledge the importance of cubic planes and stereographic projectors
- Understand the importance of crystallographic planes
- Learn the importance of miller indices

- Identify the bravais lattices

---

## 6.1 Introduction

---

In solid state chemistry crystallography and symmetry is used to characterize crystals, identify repeating parts of molecules, and simplify both data collection and nearly all calculations. Also, the symmetry of physical properties of a crystal such as thermal conductivity and optical activity must include the symmetry of the crystal. This chapter is concerned mostly with the structures of metals, ionic solids, and extended covalent structures; structures which do not contain discrete molecules as such, but which comprise extended arrays of atoms or ions. We look at the structure and bonding in these solids, how the properties of a solid depend on its structure, and how the properties can be modified by changes to the structure.

---

## 6.2 Space lattice and unit cells

---

The physical structure of solid materials of engineering importance depends mainly on the arrangements of the atoms, ions, or molecules that make up the solid and the bonding forces between them. If the atoms or ions of a solid are arranged in a pattern that repeats itself in three dimensions, they form a solid that is said to have a crystal structure and is referred to as a crystalline solid or crystalline material. Examples of crystalline materials are metals, alloys, and some ceramic materials. Atomic arrangements in crystalline solids can be described by referring the atoms to the points of intersection of a network of lines in three dimensions. Such a network is called a space lattice (Fig. 6.2 A), and it can be described as an infinite three-dimensional array of points. Each point in the space lattice has identical surroundings. In an ideal crystal the grouping of lattice points about any given point are identical with the grouping about any other lattice point in the crystal lattice. Each space lattice can thus be described by specifying the atom positions in a repeating unit cell, such as the one heavily outlined in Fig. 6.1a. The size and shape of the unit

cell can be described by three lattice vectors  $\mathbf{a}$ ,  $\mathbf{b}$ , and  $\mathbf{c}$ , originating from one corner of the unit cell (Fig. 6.2 B). The axial lengths  $a$ ,  $b$ , and  $c$  and the interaxial angles  $\alpha$ ,  $\beta$ , and  $\gamma$  are the *lattice constants* of the unit cell.

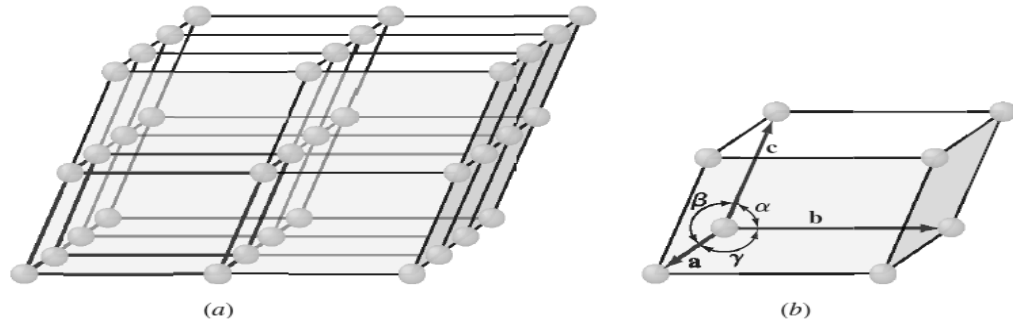

**Crystal lattice:** A crystal is a three dimensional ordered repeating arrangement of constituent unit atoms, molecules or ions. A crystal lattice may be defined as the geometric arrangement of atoms or ions in space. The position occupied by atoms or ions in the crystal lattice sites.

**Unit Cells** It is smallest repeating box like unit in space lattice which when repeated over and over results in the crystal of the substance in three dimensions. These regularly-repeating blocks are now known as *unit cells*.

#### One-and two-dimensional unit cells

The unit cell for the one-dimensional lattice in below Figure lies between the two vertical lines. If we took this unit cell and repeated it over again, we would reproduce the original array. Notice that it does not matter where in the structure we place the moved the lattice points and the unit cell, but repeating this unit cell will still give the same array—we have simply moved the origin of the unit cell.

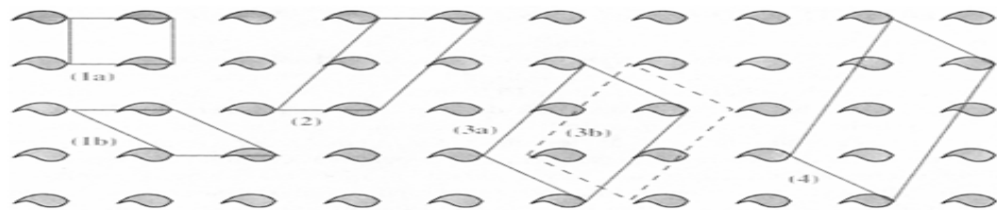

Figure 6.2 (C) Unit cell in a centred-rectangular lattice



Figure 6.2 (D)

### Translations Symmetry Elements

Introduced the idea of symmetry, both in individual molecules and for extended arrays of molecules, such as are found in crystals. Before going on to discuss three-dimensional lattices and unit cells, it is important to introduce two more symmetry elements; these elements involve translation and are only found in the solid state.

---

### 6.3. Glide plane on unit cell

---

The glide plane combines translation with reflection. Figure 6.3 (A) is an example of this symmetry element. The diagram shows part of a repeating three-dimensional structure projected on to the plane of the page; the circle represents a molecule or ion in the structure and there is distance  $a$  between identical positions in the structure. The + sign next to the circle indicates that the molecule lies above the plane of the page in the  $z$  direction. The plane of symmetry is in the  $xz$  plane perpendicular to the paper, and is indicated by the dashed line. The symmetry element consists of reflection through this plane of symmetry, followed by translation. In this case, the translation can be either in the  $x$  or in the  $z$  direction (or along a diagonal), and the translation distance is half of the repeat distance in that direction. In the example illustrated, the translation takes place in the  $x$  direction. The repeat distance between identical molecules is  $a$ , and so the translation is by  $a/2$ , and the symmetry element is called an  $a$  glide. You will notice two things about the molecule generated by this symmetry element: first, it still has a + sign

against it, because the reflection in the plane leaves the  $z$  coordinate the same and second, it now has a comma on it. Some molecules when they are reflected through a plane of symmetry are enantiomorphous, which means that they are not superimposable on their mirror image: the presence of the comma indicates that this molecule could be an enantiomorph.

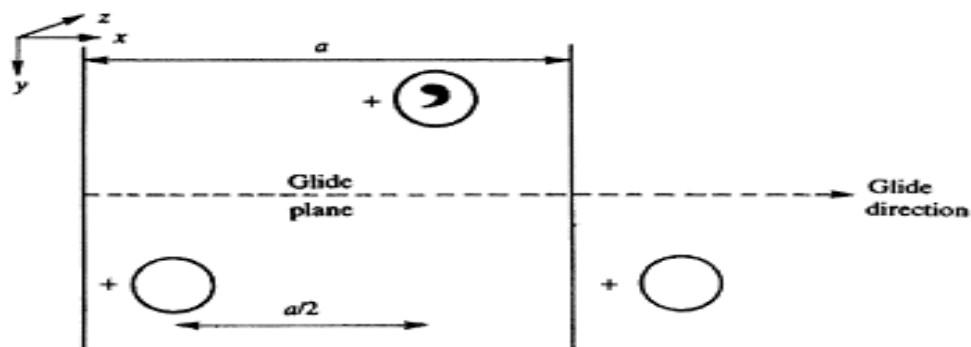

F

figure 6.3 (A) An  $a$  glide perpendicular to  $b$ .

## 6.4. Glide plane on unit cell

The screw axis combines translation with rotation. Screw axes have the general symbol  $n_i$  where  $n$  is the rotational order of the axis (i.e., twofold, threefold, etc.), and the translation distance is given by the ratio  $i/n$ . Figure 6.4 (a) illustrates a  $2_1$  screw axis. In this example, the screw axis lies along  $z$  and so the translation must be

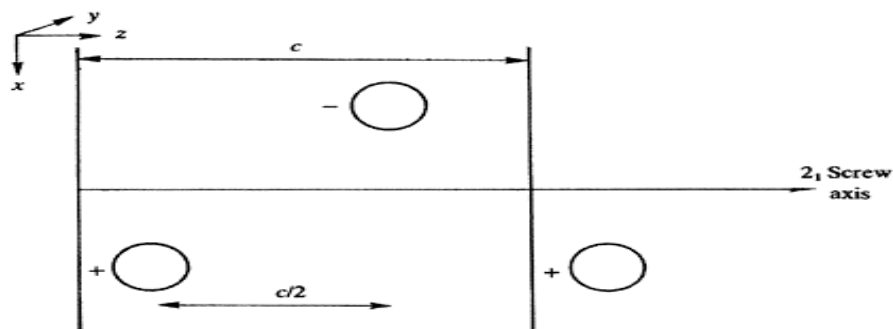

Figure 6.4 (a) A  $2_1$  screw axis along  $z$ .

in the  $z$  direction, by  $c/2$ , where  $c$  is the repeat distance in the  $z$  direction. Notice that in this case the molecule starts above the plane of the paper (indicated by the + sign) but the effect of a twofold rotation is to take it below the plane of the paper (– sign). probably illustrates this more clearly, and shows the different effects that rotational and screw axes of the same order have on a repeating structure. Rotational and screw axes produce objects that are superimposable on the original. All other symmetry elements— glide plane, mirror plane, inversion centre, and inversion axis—produce a mirror image of the original.

---

## 6.5. Three-dimensional unit cells

---

Regularly-repeating blocks are now known as *unit cells*. The dimensions of a unit cell are described by the lengths of the three axes,  $a$ ,  $b$ , and  $c$ , and the three interaxial angles,  $\alpha$ ,  $\beta$ , and  $\gamma$ . In most published papers the axial lengths are expressed in terms of Å (Ångströms), and the interaxial angles are expressed in terms of ° (degrees).

Figure 6.5 (A) Unit cell showing cell parameters.



The 7 crystal systems are listed in Table 1 below. In the lowest symmetry system, triclinic, there are no restrictions on the values of the cell parameters. In the other crystal systems, symmetry reduces the number of unique lattice parameters as shown in the Table. Certain conventions have been followed in tabulating the parameters. In the monoclinic system, one of the axes is unique in the sense that it is perpendicular to the other two axes. This axis is selected by convention as either the  $b$  or  $c$  axis so that either  $\beta$  or  $\gamma$  are  $\geq 90^\circ$ , respectively. Note that  $c$ -unique monoclinic cells are common in French literature and  $b$ -unique cells are common in most other languages. In the tetragonal, trigonal, and hexagonal systems, one axis contains higher symmetry. By convention this axis is selected as the  $c$  axis.

Crystal system	Axial lengths and interaxial angles	Space lattice
Cubic	Three equal axes at right angles $a = b = c, \alpha = \beta = \gamma = 90^\circ$	Simple cubic Body-centered cubic Face-centered cubic
Tetragonal	Three axes at right angles, two equal $a = b \neq c, \alpha = \beta = \gamma = 90^\circ$	Simple tetragonal Body-centered tetragonal
Orthorhombic	Three unequal axes at right angles $a \neq b \neq c, \alpha = \beta = \gamma = 90^\circ$	Simple orthorhombic Body-centered orthorhombic Base-centered orthorhombic Face-centered orthorhombic
Rhombohedral	Three equal axes, equally inclined $a = b = c, \alpha = \beta = \gamma \neq 90^\circ$	Simple rhombohedral
Hexagonal	Two equal axes at $120^\circ$ , third axis at right angles $a = b \neq c, \alpha = \beta = 90^\circ, \gamma = 120^\circ$	Simple hexagonal
Monoclinic	Three unequal axes, one pair not at right angles $a \neq b \neq c, \alpha = \gamma = 90^\circ \neq \beta$	Simple monoclinic Base-centered monoclinic
Triclinic	Three unequal axes, unequally inclined and none at right angles $a \neq b \neq c, \alpha \neq \beta \neq \gamma \neq 90^\circ$	Simple triclinic

---

## 6.6 Crystal systems

---

By assigning specific values for axial lengths and inter axial angles, unit cells of different types can be constructed. Crystallographers have shown that only seven different types of unit cells are necessary to create all point lattices. These crystal systems are listed in Table 1. Many of the seven crystal systems have variations of the basic unit cell. A. J. Bravais<sup>2</sup> showed that 14 standard unit cells could describe all possible lattice networks. These Bravais lattices are four basic types of unit cells: (1) simple, (2) body-centered, (3) face-centered, and (4) base centered. In the cubic system there are three types of unit cells: simple cubic, body centered cubic, and face-centered cubic. In the orthorhombic system all four types are represented. In the tetragonal system there are only two: simple and body-centered. The face-centered tetragonal unit cell appears to be missing but can be constructed from four body-centered tetragonal unit cells. The monoclinic system has simple and base-centered unit cells, and the rhombohedral, hexagonal, and triclinic systems have only one simple type of unit cell.

### ➤ Principal metallic crystal structures

In this chapter the principal crystal structures of elemental metals will be discussed. The principal ionic and covalent crystal structures that occur in ceramic materials will be treated. Most elemental metals (about 90 percent) crystallize upon solidification into three densely packed crystal *body-centered cubic (BCC)* Fig. 6.6(A), *face-centered cubic (FCC)* Fig.6.6(B) and *hexagonal close-packed (HCP)* Fig 6.6(D). The HCP structure is a denser modification of the simple hexagonal crystal structure shown in Fig. 6.11 Most metals crystallize in these dense-packed structures because energy is released as the atoms come closer together and bond more tightly with each other. Thus, the densely packed structures are in lower and more stable energy arrangements. The extremely small size of the unit cells of crystalline metals that are shown in Fig. 6.6 should be emphasized. The cube side of the unit cell of body-centered cubic iron, for example, at room temperature is equal to  $0.287 \times 10^{-9}$  m, or 0.287 nanometer (nm).<sup>3</sup> Therefore, if unit cells of pure iron are lined up side by side, in 1 mm there will be

$$1 \text{ mm} \times \frac{1 \text{ unit cell}}{0.287 \text{ nm} \times 10^{-6} \text{ mm/nm}} = 3.48 \times 10^6 \text{ unit cells!}$$

Let us now examine in detail the arrangement of the atoms in the three principal crystal structure unit cells. Although an approximation, we shall consider atoms in these crystal structures to be hard spheres. The distance between the atoms (inter atomic distance) in crystal structures can be determined experimentally by x-ray diffraction analysis. For example, the interatomic distance between two aluminum atoms in a piece of pure aluminum at 20°C is 0.2862 nm. The radius of the aluminum atom in the aluminum metal is assumed to be half the interatomic distance, or 0.143 nm. The atomic radii of selected metals are listed in Tables 2 to 4.

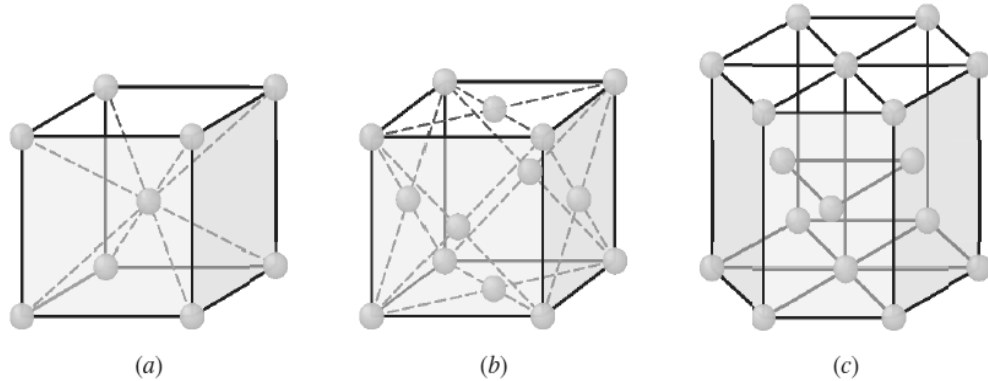

6.6 (A) BCC

6.6 (B) FCC

6.6 (C) HCP

➤ **Body-Centered Cubic (BCC) Crystal Structure:**

First, consider the atomic-site unit cell for the BCC crystal structure shown in Fig.a. In this unit cell the solid spheres represent the centers where atoms are located and clearly indicate their relative positions. If we represent the atoms in this cell as hard spheres, then the unit cell appears as shown in Fig.b. In this unit cell we see that the central atom is surrounded by eight nearest neighbours and is said to have a coordination number of 8. If we isolate a single hard-sphere unit

cell, we obtain the model shown in Fig.c. Each of these cells has the equivalent of two atoms per unit cell. One complete atom is located at the center of the unit cell, and an eighth of a sphere is located at each corner of the cell, making the equivalent of another atom. Thus there is a total of 1 (at the center) + 8 × 1/ 8 (at the corners) = 2 atoms per unit cell. The atoms in the BCC unit cell contact each other across the cube diagonal, as indicated in Fig.d, so that the relationship between the length of the cube side  $a$  and the atomic radius  $R$  is

$$\sqrt{3}a = 4R \text{ or } a = 4R / \sqrt{3}$$

If the atoms in the BCC unit cell are considered to be spherical, an atomic packing factor (APF) can be calculated by using the equation

Atomic packing factor (APF) = volume of atoms in unit cell / volume of unit cell

Metal	Lattice constant $a$ (nm)	Atomic radius $R^*$ (nm)
Chromium	0.289	0.125
Iron	0.287	0.124
Molybdenum	0.315	0.136
Potassium	0.533	0.231
Sodium	0.429	0.186
Tantalum	0.330	0.143
Tungsten	0.316	0.137
Vanadium	0.304	0.132

**Table 2 Selected Metals That Have the BCC Crystal Structure at Room Temperature (20°C) and Their Lattice Constants and Atomic Radii**

Using this equation, the APF for the BCC unit cell (Fig.a) is calculated to be 68 percent. That is, 68 percent of the volume of the BCC unit cell is occupied by atoms and the remaining 32 percent is empty space. The BCC crystal structure is *not* a close-packed structure since the atoms could be packed closer together. Many metals such as iron, chromium, tungsten, molybdenum, and vanadium have

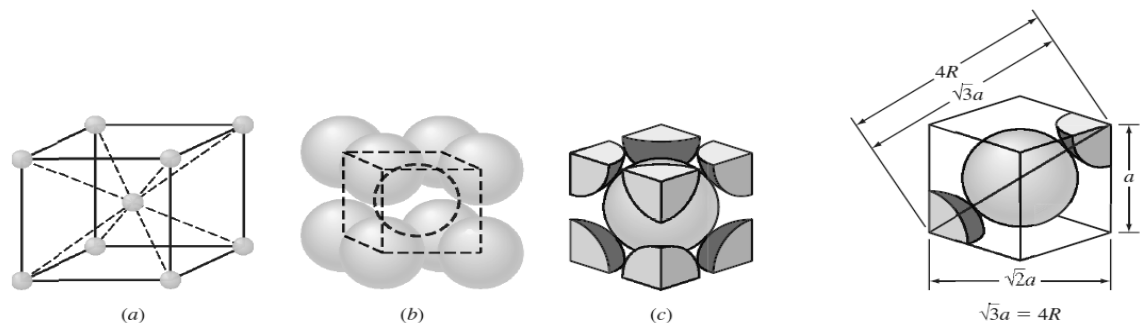

the BCC crystal structure at room temperature. Table 2 lists the lattice constants and atomic radii of selected BCC metals.

Fig.(a) Atomic-site unit cell (b)Hard-sphere unit cell (c) Isolated unit cell. (d) BCC unit cell showing relationship between the lattice constant  $a$  and the atomic radius  $R$ .

➤ **Face-Centered Cubic (FCC) Crystal Structure:**

Consider next the FCC lattice-point unit cell of Fig.a. In this unit cell there is one lattice point at each corner of the cube and one at the center of each cube face. The hard-sphere model of Fig.b indicates that the atoms in the FCC crystal structure are packed as close together as possible. The APF for this close packed structure is 0.74 as compared to 0.68 for the BCC structure, which is not close-packed. The FCC unit cell as shown in Fig.c has the equivalent of four atoms per unit cell. The eight corner octants account for one atom ( $8 \times 1/8 = 1$ ), and the six half-atoms on the cube faces contribute another three atoms, making a total of four atoms per unit cell. The atoms in the FCC unit cell contact each other across the cubic face diagonal, as indicated in Fig.d, so that the relationship between the length of the cube side  $a$  and the atomic radii

$$\sqrt{2}a = 4R \text{ or } a = 4R/\sqrt{2}$$

Metal	Lattice constant $a$ (nm)	Atomic radius $R^*$ (nm)
Aluminum	0.405	0.143
Copper	0.3615	0.128
Gold	0.408	0.144
Lead	0.495	0.175
Nickel	0.352	0.125
Platinum	0.393	0.139
Silver	0.409	0.144

**Table 3 Selected Metals That Have the FCC Crystal Structure at Room Temperature (20°C) and Their Lattice Constants and Atomic Radii**

The APF for the FCC crystal structure is 0.74, which is greater than the 0.68 factor for the BCC structure. The APF of 0.74 is for the closest packing possible

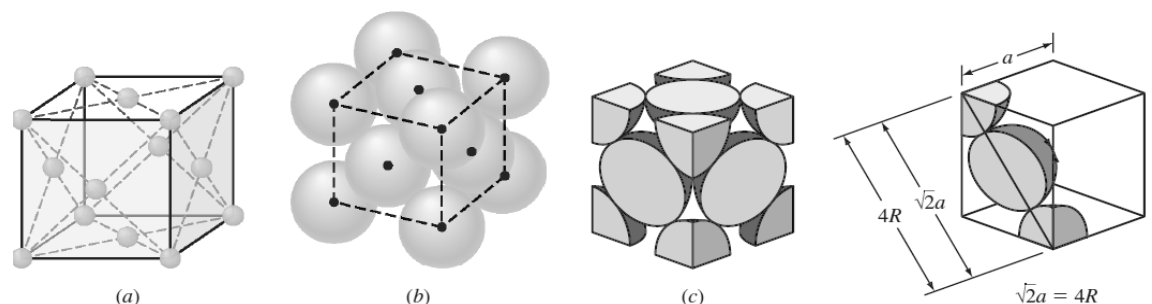

of “spherical atoms.” Many metals such as aluminum, copper, lead nickel, and iron at elevated temperatures (912 to 1394°C) crystallize with the FCC crystal structure. Table 3 lists the lattice constants and atomic radii for some selected FCC metals.

Fig.(a) atomic-site unit cell (b) hard-sphere unit cell (c) isolated unit cell. (d) FCC unit cell showing relationship between the lattice constant  $a$  and atomic radius  $R$ . Since the atoms touch across the face diagonals  $2a = 4R$ .

➤ **Hexagonal Close-Packed (HCP) Crystal Structure:**

The third common metallic crystal structure is the HCP structure shown in Fig. Metals do not crystallize into the simple hexagonal crystal structure shown in Fig.6.7 because the APF is too low. The atoms can attain a lower energy and a more stable condition by forming the HCP structure of below Fig. The APF of the HCP crystal structure is 0.74, the same as that for the FCC crystal structure since in both structures the atoms are packed as tightly as possible. In both the HCP and FCC crystal structures each atom is surrounded by 12 other atoms, and thus both structures have a coordination number of 12. The differences in the atomic packing in FCC and HCP crystal structures will be discussed in Sec. 6.10 The isolated HCP unit cell is shown in below Fig. and has the equivalent of six

Metal	Lattice constants (nm)		Atomic radius $R$ (nm)	$c/a$ ratio	% deviation from ideality
	$a$	$c$			
Cadmium	0.2973	0.5618	0.149	1.890	+15.7
Zinc	0.2665	0.4947	0.133	1.856	+13.6
Ideal HCP				1.633	0
Magnesium	0.3209	0.5209	0.160	1.623	-0.66
Cobalt	0.2507	0.4069	0.125	1.623	-0.66
Zirconium	0.3231	0.5148	0.160	1.593	-2.45
Titanium	0.2950	0.4683	0.147	1.587	-2.81
Beryllium	0.2286	0.3584	0.113	1.568	-3.98

atoms per unit cell. Three atoms form a triangle in the middle layer, as indicated by the atomic sites in below Fig.a. There are six  $1/6$ -atom sections on both the top and bottom layers, making an equivalent of two more atoms ( $2 \times 6 \times 1/6 = 2$ ).

**Table 4 Selected Metals That Have the HCP Crystal Structure at Room Temperature (20°C) and Their Lattice Constants, Atomic Radii, and  $c/a$  Ratios**

Finally, there is one-half of an atom in the center of both the top and bottom layers, making the equivalent of one more atom. The total number of atoms in the HCP crystal structure unit cell is thus  $3 + 2 + 1 = 6$ . The ratio of the height  $c$  of the hexagonal prism of the HCP crystal structure to its basal side  $a$  is called the  $c/a$  ratio (Fig.a). The  $c/a$  ratio for an ideal HCP crystal structure consisting of uniform spheres packed as tightly together as possible is 1.633. Table 4 lists some important HCP metals and their  $c/a$  ratios. Of the metals listed, cadmium and zinc have  $c/a$  ratios higher than ideality, which indicates that the atoms in these structures are slightly elongated along the  $c$  axis of the HCP unit cell. The metals magnesium, cobalt, zirconium, titanium, and beryllium have  $c/a$  ratios less than

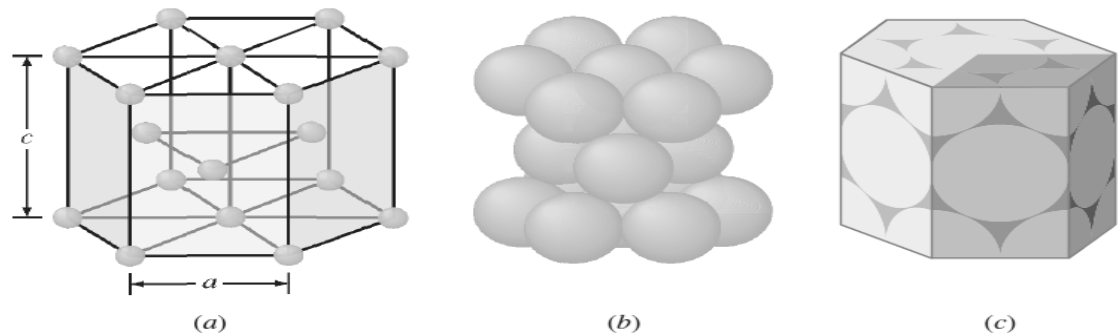

the ideal ratio. Therefore, in these metals the atoms are slightly compressed in the direction along the  $c$  axis. Thus, for the HCP metals listed in Table 4 there is a certain amount of deviation from the ideal hard-sphere model.

Fig. (a) Atomic-site unit cell

(b) Hard-sphere unit cell

(c) Isolated unit cell

## 6.7. Bravais lattices

The number of lattices that can fill two- or three-dimensional space with periodically repeating units without leaving gaps or cause overlaps is limited. Therefore, there is a finite number of different crystal structures, and different crystalline solids may crystallise according to the same pattern. The *metrics* of the lattice may be different, but the *symmetry* is the same in such cases. Lattices

which fill space without gaps are called *Bravais lattices*. There are five of them in two dimensions and 14 in three dimensions.

### 6.11.(A) Bravais lattices in two dimensions

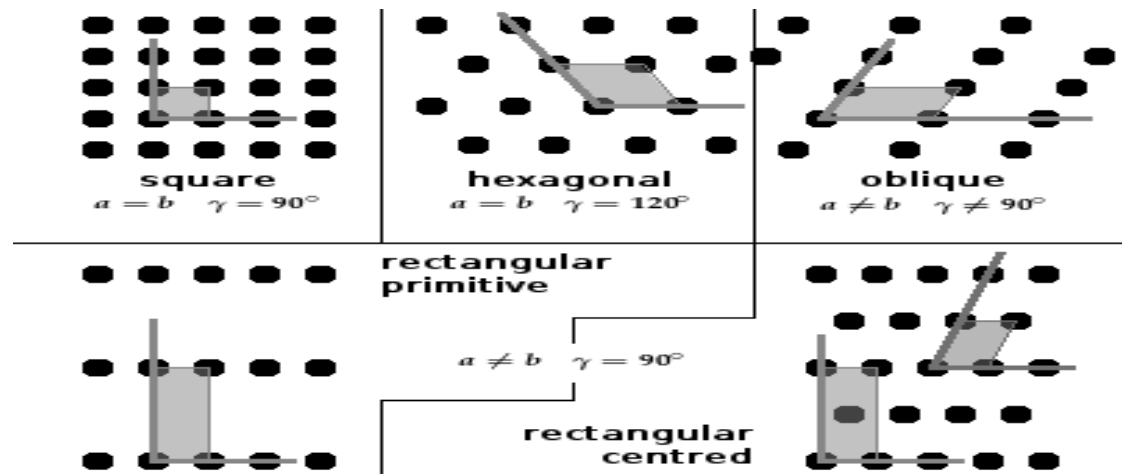

The most general and least symmetric Bravais lattice in two dimensions is the *oblique* lattice. If the angle between the two lattice vectors is  $90^\circ$ , the higher symmetry of the cell gives rise to a distinct Bravais lattice, either *rectangular* or *square* depending on whether the unit cell vectors have different length or not. In the case of a rectangular lattice, we can distinguish between a *primitive rectangular* lattice and a *centred rectangular* lattice, which has an extra lattice point (atom) at the centre. The centred rectangular lattice could be set up as a primitive lattice with lower symmetry (unit cell shown in green), but convention prefers the more symmetric description. Finally, if the lattice vectors are the same length and the angle is  $120^\circ$ , we have another special case with higher symmetry, the *hexagonal* lattice.



### 6.11. (B) Symmetry elements in two dimensions

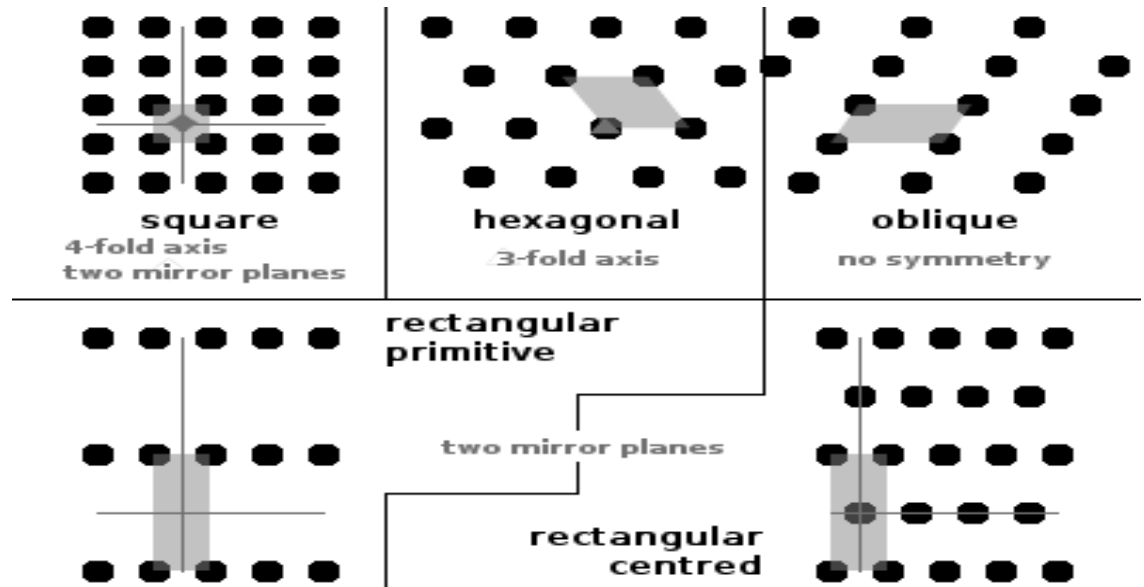

Clearly, the difference between the Bravais lattices boils down to symmetry. If the lattice vectors are at right angles, the unit cell can be folded over along lines intersecting either lattice vector at its centre: there are *mirror lines* crossing each pair of edges of the unit cell in the middle, and the two mirror lines intersect at the centre of the cell. This explains the special position of the central point in the centred rectangular lattice - it is located at the centre of symmetry of the cell and always maps onto itself under any symmetry operation.

In two dimensions, the effect of a mirror line and a rotation by  $180^\circ$  is the same, so the rectangular lattices both have a two-fold rotation axis at their centre. In the case of the square lattice, it is even a four-fold axis - turning the cell by  $90^\circ$  maps it onto itself because both lattice vectors are the same length. This is indicated by a green diamond shape in the diagram. There is also a four-fold axis in each corner of the cell: a  $90^\circ$  rotation around any of the lattice points again maps the lattice (though not the specific unit cell) onto itself. The hexagonal lattice has a three-fold symmetry by rotating in  $120^\circ$  steps around a lattice point, indicated by a triangular marker.

### 6.11. (C) Bravais lattices in three dimensions

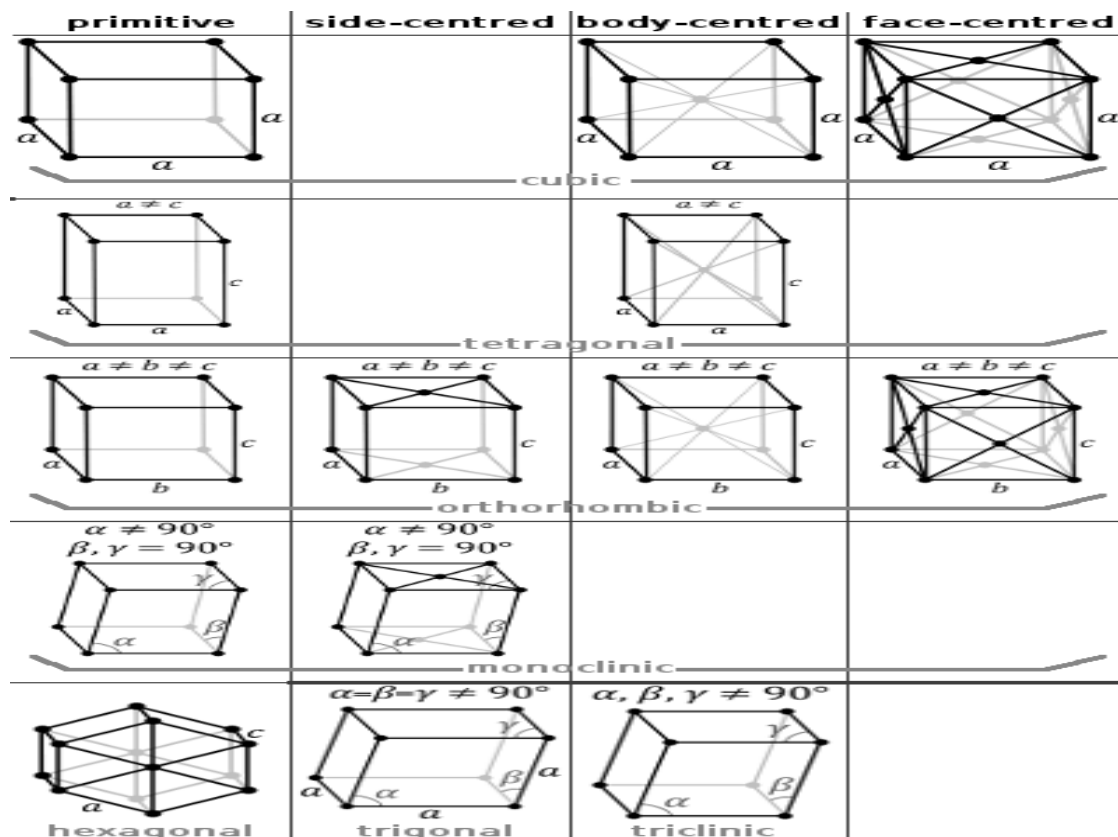

The same symmetry principles apply in three dimensions. The concept of a centred lattice expands into three distinct cases, depending on whether the additional point is at the centre of the unit cell (*body-centred*), of one face and, because of the translational periodicity, its opposite (*side-centred*) or on all its faces (*face-centred*).

By convention, the lattice vectors are named  $a$ ,  $b$  and  $c$  and the angles are given the Greek letter corresponding to the lattice vector that is *not* spanning the angle, *i.e.* the angle between  $a$  and  $c$  is  $\beta$ . The equivalent of the two-dimensional oblique lattice in three dimensions is the *triclinic* Bravais lattice. All angles are irregular

and the three lattice vectors have different lengths. More symmetric lattices arise when some or all angles are  $90^\circ$  or  $120^\circ$  or when two or all three lattice vectors have the same length.

Among the lattices with exclusively right angles are the *orthorhombic*, *tetragonal* and cubic lattices depending on whether there are three, two or just one distinct lattice vectors in terms of their length. If only two angles are  $90^\circ$ , the cell is monoclinic, resulting in four rectangular and two skewed faces to the unit cell. If none of the angles is a right angle, the cell is *trigonal* if all lattice vectors are the same length but *triclinic* if they are different. Finally, the *hexagonal* lattice has one angle at  $120^\circ$  and two at  $90^\circ$ .

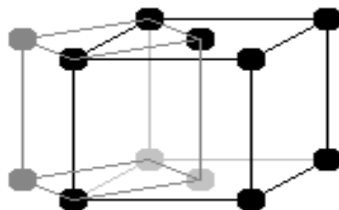

The gaps in the table arise because the missing lattices can be expressed in terms of one of the others by choosing a different unit cell. For example, a side-centred cubic lattice is the same as a primitive tetragonal one with a smaller unit cell based on four of the corner atoms and four side-centred atoms of the cubic cell.

---

## 6.12 Miller indices for crystallographic planes in cubic unit cells

---

Sometimes it is necessary to refer to specific lattice planes of atoms within a crystal structure, or it may be of interest to know the crystallographic orientation of a plane or group of planes in a crystal lattice. To identify crystal planes in cubic crystal structures, the *Miller notation system* is used. The *Miller indices of a crystal plane* are defined as the *reciprocals of the fractional intercepts (with fractions cleared) that the plane makes with the crystallographic  $x$ ,  $y$ , and  $z$  axes of the three nonparallel edges of the cubic unit cell*. The cube edges of the unit cell represent unit lengths, and the intercepts of the lattice planes are measured in terms of these unit lengths.

The procedure for determining the Miller indices for a cubic crystal plane is as follows:

1. Choose a plane that does *not* pass through the origin at  $(0, 0, 0)$ .
2. Determine the intercepts of the plane in terms of the crystallographic  $x$ ,  $y$ , and  $z$  axes for a unit cube. These intercepts may be fractions.
3. Form the reciprocals of these intercepts.
4. Clear fractions and determine the *smallest* set of whole numbers that are in the same ratio as the intercepts.

These whole numbers are the Miller indices of the crystallographic plane and are enclosed in parentheses without the use of commas. The notation  $(hkl)$  is used to indicate Miller indices in a general sense, where  $h$ ,  $k$ , and  $l$  are the Miller indices of a cubic crystal plane for the  $x$ ,  $y$ , and  $z$  axes, respectively. Figure 6.12 shows three of the most important crystallographic planes of cubic crystal structures. Let us first consider the shaded crystal plane in Fig6.12a, which has the intercepts  $1$ ,  $\infty$ ,  $\infty$  for the  $x$ ,  $y$ , and  $z$  axes, respectively. We take the reciprocals of these intercepts to obtain the Miller indices, which are therefore  $1, 0, 0$ . Since these numbers do not involve fractions, the Miller indices for this plane are  $(100)$ , which is read as

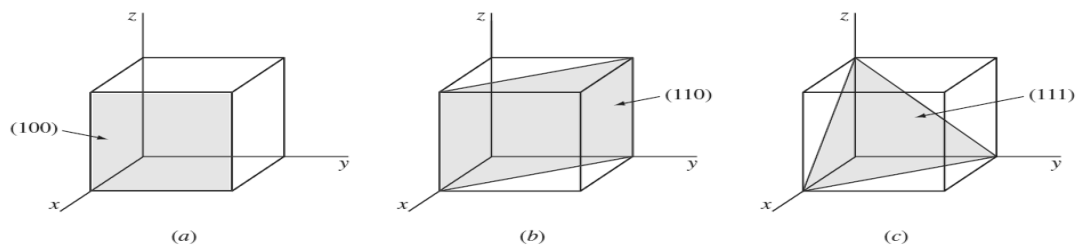

Miller indices of some important cubic crystal planes: (a)  $(100)$ , (b)  $(110)$ , and (c)  $(111)$

the one-zero-zero plane. Next let us consider the second plane shown in Fig6.12b. The intercepts of this plane are  $1, 1, \infty$ . Since the reciprocals of these numbers are

1, 1, 0, which do not involve fractions, the Miller indices of this plane are (110). Finally, the third plane (Fig.12c) has the intercepts 1, 1, 1, which give the Miller indices (111) for this plane. Consider now the cubic crystal plane shown in Fig. 3.14 which has the intercepts  $1/3$ ,  $2/3$ , 1. The reciprocals of these intercepts are 3,  $3/2$ , 1. Since fractional intercepts are not allowed, these fractional intercepts must be multiplied by 2 to clear the  $3/2$  fraction.

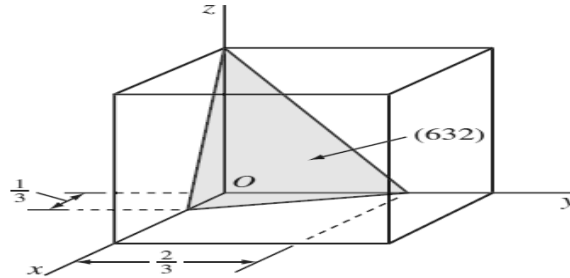
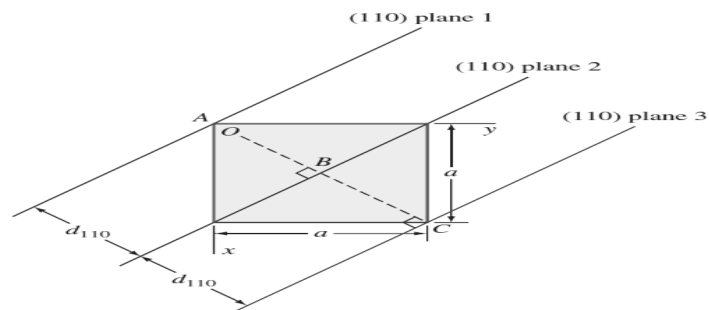

Fig.

Cubic crystal plane (632), which has fractional intercepts.

Thus, the reciprocal intercepts become 6, 3, 2 and the Miller indices are (632). If the crystal plane being considered passes through the origin so that one or more intercepts are zero, the plane must be moved to an equivalent position in the same unit cell and the plane must remain parallel to the original plane. This is possible because all equispaced parallel planes are indicated by the same Miller indices. If sets of equivalent lattice planes are related by the symmetry of the crystal system, they are called *planes of a family or form*, and the indices of one plane of the family are enclosed in braces as  $\{hkl\}$  to represent the indices of a family of symmetrical planes. For example, the Miller indices of the cubic surface planes (100), (010), and (001) are designated collectively as a family or form by the notation  $\{100\}$ .



Top view of cubic unit cell showing the distance between (110) crystal planes,  $d_{110}$

An important relationship for the cubic system, and only the cubic system, is that the direction indices of a direction perpendicular to a crystal plane are the same as the Miller indices of that plane. For example, the [100] direction is perpendicular to the (100) crystal plane. In cubic crystal structures the interplanar spacing between two closest parallel planes with the same Miller indices is designated  $d_{hkl}$ , where  $h$ ,  $k$ , and  $l$  are the Miller indices of the planes. This spacing represents the distance from a selected origin containing one plane and another parallel plane with the same indices that is closest to it. For example, the distance between (110) planes 1 and 2,  $d_{110}$ , in Fig. 3.15 is AB. Also, the distance between (110) planes 2 and 3 is  $d_{110}$  and is length BC in Fig. 3.15. From simple geometry, it can be shown that for cubic crystal structures

$$d_{hkl} = a/\sqrt{h^2 + k^2 + l^2}$$

where  $d_{hkl}$  = interplanar spacing between parallel closest planes with Miller indices  $h$ ,  $k$ , and  $l$

$a$  = lattice constant (edge of unit cube)

$h, k, l$  = Miller indices of cubic planes being considered

---

## 6.13 Stereographic Projection in Crystallography

---

Drawing the three-dimensional symmetry operations on a two-dimensional surface such as this page has been a difficult problem. One way to overcome this problem is through the use of a *stereographic projection*. Such figures are also effective in describing the angular relations among the faces of a crystal.

To construct a stereographic projection, imagine that the object with a given symmetry or surface is at the center of a sphere. Consider the sphere to have a polar axis that is bisected by an equatorial plane. Project features of interest on the object from the center, out to the surface of the sphere. Then project the points on the surface of the sphere through the equatorial plane to the point where the polar axis intersects the sphere in the opposite hemisphere. The stereographic projection

is then given by the equatorial plane and all intersections of the plane by the projected points. If the projection point started in the northern hemisphere then its projection onto the equatorial plane is represented as a plus. Points originating in the southern hemisphere are denoted with a circle. Sometimes points generated by improper symmetry operations are also denoted with a comma to indicate opposite handedness.

The unit cell axis with highest symmetry is usually selected as the polar axis. Rotation axes not in the equatorial plane are drawn with the symbol representing the type of axis at the projection point on the equatorial plane. Rotation axes in the equatorial plane are drawn outside of the projection terminating in arrows. Mirror planes are drawn as thickened lines. Inversion centers are drawn as open circles in the center of the polar axis.

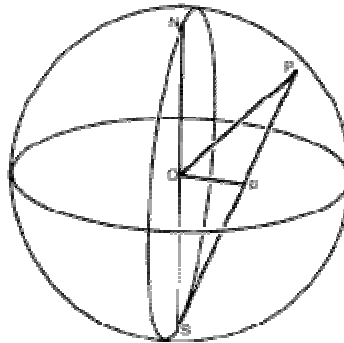

**Figure** The point p is the stereographic projection of the point P on the sphere

---

## Summary

---

This Chapter increase the knowledge of atomic arrangements in crystalline solids. In metals the most common crystal structure unit cells are: *body-centered cubic* (BCC), *face-centered cubic* (FCC), and *hexagonal close-packed* (HCP), (which is a dense variation of the simple hexagonal structure).

---

## Review Questions

---

1. Define a crystal structure. Give examples of materials that have crystal

- structures?
2. What is the coordination number for the atoms in the BCC crystal structure?
  3. Define a unit cell of a space lattice. What lattice constants define a unit cell?
  4. What are the 14 Bravais unit cells?
  5. How are the indices for a crystallographic direction in a cubic unit cell determined?
  6. Draw the following directions in a BCC unit cell and list the position coordinates of the atoms whose centers are intersected by the direction vector: (a) [100] (b) [110] (c) [111]
  7. Determine the Miller-Bravais direction indices of the  $-a$ ,  $-a_2$ , and  $-a_3$  directions?

---

## Reference and Suggested reading

---

1. Inorganic Chemistry - James E Huheey (Principle of Stc.&Reactivity)
2. Solid State Chemistry & its applications (1<sup>st</sup> edition)- Anthony R.West (Wiley Publication)
3. This is a brief description of *Neumann's Principle*. See [http://reference.iucr.org/dictionary/Neumann's principle](http://reference.iucr.org/dictionary/Neumann's_principle)
4. [nanoscienceandnanodevicelab.weebly.com/uploads/7/6/.../chapter\\_3.pdf](http://nanoscienceandnanodevicelab.weebly.com/uploads/7/6/.../chapter_3.pdf) W. G. Moffatt, G. W. Pearsall, and J. Wulff, "The Structure and Properties of Materials" vol. I: "Structure" Wiley



---

# Unit - 7 :Hydrogen Group

---

## Structure of Unit:

- 7.0 Objectives
- 7.1 Introduction
- 7.2 Hydrogen
- 7.3 Compounds of Hydrogen
- 7.4 Hydride classification
- 7.5 Phosphene (PH<sub>3</sub>)
- 7.6 Antimony Hydride (SbH<sub>2</sub>)
- 7.7 Arsanic Hydride (AsH<sub>2</sub>)
- 7.8 Selenides
- 7.9 Tellurides
- 7.10 Summery
- 7.11 Review Question
- 7.12 Reference and Suggested readings

---

## 7.0 Objectives

---

At the end of the unit learner will be able to

- Deep knowledge about Hydrogen element.
- Know about hydrides and their classification.
- Learn about different hydrides, their properties, the methods of synthesis, applications, and specially toxicity of different hydrides.

---

## 7.1 Introduction

---

This chapter deal with the hydrogen and its compounds. Hydrogen is a chemical element which is denoted by symbol H and atomic number 1. With an atomic weight of 1.00794 u, hydrogen is the lightest element on the periodic table. Its mono atomic form (H) is the most abundant chemical substance in the universe, constituting roughly 75% of all baryonic mass. Non-remnant stars are mainly composed of hydrogen in its plasma state.  $H_2$  is not very reactive under standard conditions so it does form compounds with most elements. Hydrogen can form compounds with elements that are more electronegative, such as halogens (e.g., F, Cl, Br, I), or oxygen; in these compounds hydrogen takes on a partial positive charge. When bonded to fluorine, oxygen, or nitrogen, hydrogen can participate in a form of medium-strength noncovalent bonding called hydrogen bonding, which is critical to the stability of many biological molecules.

---

## 7.2 Hydrogen

---

Hydrogen is a chemical element which is denoted by symbol H and atomic number 1. With an atomic weight of 1.00794 u, hydrogen is the lightest element on the periodic table. Its mono atomic form (H) is the most abundant chemical substance in the universe, constituting roughly 75% of all baryonic mass. Non-remnant stars are mainly composed of hydrogen in its plasma state. The most common isotope of hydrogen, termed protium, has a single proton and zero neutrons. Hydrogen is a colourless, odorless, on-toxic, nonmetallic, highly combustible diatomic gas with the molecular formula  $H_2$  at standard temperature and pressure. Since hydrogen readily forms covalent compounds with most non-metallic elements, most of the hydrogen on Earth exists in molecular forms such as in the form of water ororganic compounds. Hydrogen plays a particularly important role in acid–base reactions. In ionic compounds, hydrogen can take the form of a negative charge (i.e., anion) known as a hydride, or as a positively charged (i. e. cation) species denoted by the symbol  $H^+$ . The hydrogen cation is written as though composed of a bare proton, but in reality, hydrogen cations in ionic compounds are always more complex

species than that would suggest. The hydrogen atom known as the simplest atom has had considerable theoretical application. For example, the hydrogen atom is the only neutral atom with an analytic solution to the Schrödinger equation. Hydrogen gas was first artificially produced via the mixing of metals with acids. Industrial production is mainly from the steam reforming of natural gas, and less often from more energy-intensive hydrogen production methods like the electrolysis of water. Most hydrogen is employed near its production site, with the two largest uses being fossil fuel processing and ammonia production, mostly for the fertilizer. Hydrogen is a concern in metallurgy as it can embitter many metals, complicating the design of pipelines and storage tanks.

---

## 7.3 Compounds of Hydrogen

---

### Covalent and organic compounds

H<sub>2</sub> is not very reactive under standard conditions so it does form compounds with most elements. Hydrogen can form compounds with elements that are more electronegative, such as halogens (e.g., F, Cl, Br, I), or oxygen; in these compounds hydrogen takes on a partial positive charge. When bonded to fluorine, oxygen, or nitrogen, hydrogen can participate in a form of medium-strength noncovalent bonding called hydrogen bonding, which is critical to the stability of many biological molecules. Hydrogen also forms compounds with less electronegative elements, such as the metals and metalloids, in which it takes on a partial negative charge. These compounds are often known as hydrides. Hydrogen forms a vast collection of compounds with carbon called the hydrocarbons, and an even vaster array with heteroatoms that, because of their general association with living things, are called organic compounds. By some definitions, "organic" compounds are only required to contain carbon. However, most of them also contain hydrogen, and because it is the carbon-hydrogen bond which gives this class of compounds most of its particular chemical characteristics, carbon-hydrogen bonds are required in some definitions of the word "organic" in chemistry. Millions of hydrocarbons are known, and they are usually formed by complicated synthetic pathways, which seldom involve elementary hydrogen.

## Protons and acids

Oxidation of hydrogen removes its electron and gives  $H^+$ , which contains no electrons and a nucleus which is usually composed of one proton. That is why  $H^+$  is frequently called a proton. Under the Bronsted-Lowry theory, acids are proton donors, while bases are proton acceptors. The term 'proton' is sometimes used loosely and metaphorically to refer to positively charged or cationic hydrogen attached to other species in this fashion, and as such is denoted " $H^+$ " without any implication that any single protons exist freely as a species. To avoid the inference of the naked "solvated proton" in solution, acidic aqueous solutions are sometimes considered to contain a less unlikely fictitious species, termed the "hydronium ion" ( $H_3O^+$ ). However, even in this case, such solvated hydrogen cations are more realistically conceived as being organized into clusters that form species closer to  $H_9O^{+4}$ . Other oxonium ions are found when water is in acidic solution with other solvents.

## Hydrides

Compounds of hydrogen are called hydrides, a term that is used fairly loosely. The term "hydride" suggests that the H atom has acquired a negative or anionic character, denoted  $H^-$ , and is used when hydrogen forms a compound with a more electropositive element. The existence of the hydride anion, suggested by Gilbert N. Lewis in 1916 for group I and II salt-like hydrides, was demonstrated by Moers in 1920 by the electrolysis of molten lithium hydride (LiH), producing a stoichiometry quantity of hydrogen at the anode. For hydrides other than group I and II metals, the term is quite misleading, considering the low electronegativity of hydrogen. An exception in group II hydrides is  $BeH_2$ , which is polymeric. In lithium aluminium hydride, the  $AlH_4^-$  anion carries hydridic centers firmly attached to the Al(III). Although hydrides can be formed with almost all main-group elements, the number and combination of possible compounds varies widely; for example, there are over 100 binary borane hydrides known, but only one binary aluminium hydride. Binary indium hydride has not yet been identified, although larger complexes exist. Hydrides can also serve as bridging ligands that link two metal centers in a coordination complex. This function is particularly

common in group 13 elements, especially in boranes (boron hydrides) and aluminium complexes, as well as in clustered carboranes.

---

## 7.4 Hydride classification

---

Every element of the periodic table (except some noble gases) forms one or more hydrides. These substances have been classified into three main types according to the nature of their bonding:

- Ionic hydrides, which have significant ionic bonding character.
- Covalent hydrides, which include the hydrocarbons and many other compounds which covalently bond to hydrogen atoms.
- Interstitial hydrides, which may be described as having metallic bonding.

While these divisions have not been used universally, they are still useful to understand differences in hydrides.

### Ionic hydrides

In ionic or saline hydride, a hydrogen atom bound to an extremely electropositive metal, generally an alkali metal or alkaline earth metal. In these materials the hydrogen atom is viewed as a pseudo halide. Saline hydrides are insoluble in conventional solvents, reflecting their non molecular structures. Most ionic hydrides exist as "binary" materials involving only two elements including hydrogen. Ionic hydrides are used as heterogeneous bases and reducing reagents in organic synthesis.

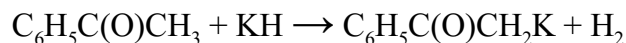

Typical solvents for such reactions are ethers. Water and other protic solvents cannot serve as a medium for ionic hydrides because the hydride ion is a stronger base than hydroxide and most hydroxyl anions. Hydrogen gas is liberated in a typical acid-base reaction.

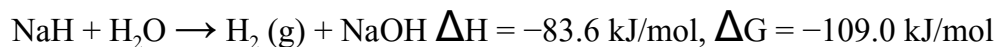

Often alkali metal hydrides react with metal halides. Lithium aluminium hydride (often abbreviated as LAH) arises from reactions of lithium hydride with aluminium chloride.

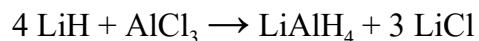

### **Covalent Hydrides**

The first major group is covalent hydrides, which is when a hydrogen atom and one or more non-metals form compounds. This occurs when hydrogen covalently bonds to a more electropositive element by sharing electron pairs. These hydrides can be volatile or non-volatile. Volatile simply means being readily able to be vaporized at low temperatures. One such example of a covalent hydride is when hydrogen bonds with chlorine and forms hydrochloric acid (HCl). Examples are listed below:

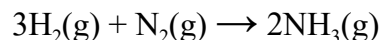
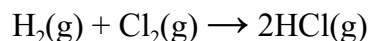

The hydrides of nonmetals on the periodic table become more electronegative as you move from group 13 to 17. This means that they are less capable of donating an electron, and want to keep them because their electron orbital becomes fuller. Instead of donating a  $\text{H}^-$ , they would instead donate a  $\text{H}^+$  because they are more acidic.

Covalent or Molecular hydrides are classified on the basis of the presence of the total number of electrons and bonds in their Lewis structures as:

#### **1. Electron-deficient hydrides**

#### **2. Electron-precise hydrides**

#### **3. Electron-rich hydrides**

An electron-deficient hydride has very few electrons, less than that required for representing its conventional Lewis structure e.g. diborane ( $\text{B}_2\text{H}_6$ ). In  $\text{B}_2\text{H}_6$ , there are six bonds in all, out of which only four bonds are regular two centered-two electron bonds. The remaining two bonds are three centered-two electron bonds

i.e., two electrons are shared by three atoms. Hence, its conventional Lewis structure cannot be drawn. An electron-precise hydride has a sufficient number of electrons to be represented by its conventional Lewis structure e.g. CH<sub>4</sub>. The Lewis structure can be written as:

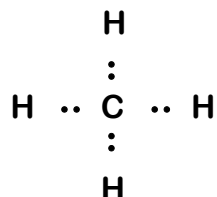

Four regular bonds are formed where two electrons are shared by two atoms. An electron-rich hydride contains excess electrons as lone pairs e.g. NH<sub>3</sub>.

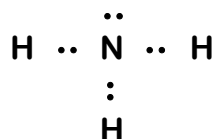

There are three regular bonds in ammonia with a lone pair of electrons on the nitrogen atom.

### **Metallic Hydrides**

The next category of hydrides are metallic hydrides, also known as interstitial hydrides. Hydrogen bonds with transition metals. One interesting and unique characteristic of these hydrides are that they can be nonstoichiometric, meaning basically that the fraction of H atoms to the metals are not fixed. Nonstoichiometric compounds have a variable composition. The idea and basis for this is that with metal and hydrogen bonding there is a crystal lattice that H atoms can and may fill in between the lattice while some might, and is not a definite ordered filling. Thus it is not a fixed ratio of H atoms to the metals. Even so, metallic hydrides consist of more basic stoichiometric compounds as well.

## **7.5 Phosphene (PH<sub>3</sub>)**

Phosphine is a hydride of phosphorus with the chemical formula PH<sub>3</sub>. It is a colorless, flammable, toxic gas. Pure phosphine is odorless, but technical grade

samples have a highly unpleasant odor like garlic or rotting fish, due to the presence of substituted phosphine and diphosphane ( $P_2H_4$ ). With traces of  $P_2H_4$  present,  $PH_3$  is spontaneously flammable in air, burning with a luminous flame. Phosphines are also a group of organophosphorus compounds with the formula  $R_3P$  ( $R$  = organic derivative). Organophosphines are important in catalysts where they complex to various metal ions; complexes derived from a chiral phosphine can catalyze reactions to give chiral, enantioenriched products. Because of its strong association with elemental phosphorus, phosphine was once regarded as a gaseous form of the element, but Lavoisier (1789) recognised it as a combination of phosphorus with hydrogen and described it as “hydruret of phosphorus, or phosphuret of hydrogen”.

### **Structure and properties**

Phosphine is a trigonal pyramidal molecule with molecular symmetry  $C_{3v}$ . The length of the P-H bond is 1.42 Å, the H-P-H bond angles are  $93.5^\circ$ . The dipole moment is 0.58 D, which increases with substitution of methyl groups in the series:  $CH_3PH_2$ , 1.10 D;  $(CH_3)_2PH$ , 1.23 D;  $(CH_3)_3P$ , 1.19 D. In contrast, the dipole moments of amines decrease with substitution, starting with ammonia, which has a dipole moment of 1.47 D. The low dipole moment and almost orthogonal bond angles lead to the conclusion that in  $PH_3$  the P-H bonds are almost entirely  $p\sigma(P) - s\sigma(H)$  and phosphorus 3s orbital contributes little to the bonding between phosphorus and hydrogen in this molecule. For this reason, the lone pair on phosphorus may be regarded as predominantly formed by the 3s orbital of phosphorus. The upfield chemical shift of the phosphorus atom in the  $^{31}P$  NMR spectrum accords with the conclusion that the lone pair electrons occupy the 3s orbital (Fluck, 1973). This electronic structure leads to a lack of nucleophilicity and an ability to form only weak hydrogen bonds.

The solubility of  $PH_3$  in aqueous solution is slight; 0.22 mL of gas dissolve in 1 mL of water. Phosphine dissolves more readily in non-polar solvents than in water because of the non-polar P-H bonds. It acts as neither an acid nor a base in water. Proton exchange proceeds via a phosphonium ( $PH_4^+$ ) ion in acidic solutions and via  $PH_2^-$  at high pH, with equilibrium constants  $K_b = 4 \times 10^{-28}$  and  $K_z = 41.6 \times 10^{-29}$ .



### **Synthesis and occurrence**

$\text{PH}_3$  may be prepared in a variety of ways. In industries it can be made by the reaction of white phosphorus with sodium hydroxide, producing sodium hypophosphite and sodium phosphite as a by-product. Alternatively the acid-catalyzed disproportioning of white phosphorus may be used, which yields phosphoric acid and phosphine. Both routes have industrial significance; the acid route is preferred method if further reaction of the phosphine to substituted phosphines is needed. The acid route requires purification and pressurizing. It can also be made (as described above) by the hydrolysis of a metal phosphide, such as aluminium phosphide or calcium phosphide. Pure samples of phosphine, free from  $\text{P}_2\text{H}_4$ , may be prepared using the action of potassium hydroxide on phosphonium iodide ( $\text{PH}_4\text{I}$ ). Phosphine is probably a constituent of the atmosphere at very low and highly variable concentrations and hence may contribute to the global phosphorus biochemical cycle. The origin(s) of atmospheric phosphine is not certain. Possible sources include bacterial reduction of phosphate in decaying organic matter and the corrosion of phosphorus-containing metals.

### **Applications**

#### **Organophosphorus chemistry**

Phosphine is mainly consumed as an intermediate in organophosphorus compounds. In an illustrative reaction, formaldehyde adds in the presence of hydrogen chloride to give tetraakis(hydroxymethyl)phosphonium chloride, which is used in textiles.

#### **Microelectronics**

Small amounts of it are used as a dopant in the semiconductor industry, and a precursor for the deposition of compound semiconductors.

#### **Fumigant**

It is used in farms also as pellets of aluminium phosphide, calcium phosphide, or zinc phosphide release phosphine upon contact with atmospheric water or rodents' stomach acid. These pellets also contain agents to reduce the potential for ignition or explosion of the released phosphine. Because the previously popular fumigant methyl bromide has been phased out in some countries under the Montreal Protocol, phosphine is the only widely used, cost-effective, rapidly acting fumigant

that does not leave residues on the stored product. Pests developing high levels of resistance toward phosphine have become common in Asia, Australia and Brazil. High level resistance is also likely to occur in other regions, but may not have been as closely monitored.

### **Safety**

Phosphine is more dense gas than air and hence may collect in low-lying areas. It can form explosive mixtures with air and also self-ignite. When phosphine burns it produces a dense white cloud of phosphorus pentoxide which is a severe respiratory irritant.

Phosphine can be absorbed into the body by inhalation. Direct contact with phosphine liquid may cause frostbite, like other cryogenic liquids. The main target organ of phosphine gas is the respiratory tract. According to the 2009 U.S. National Institute for Occupational Safety and Health (NIOSH) pocket guide, and U.S. Occupational Safety and Health Administration (OSHA) regulation, the 8 hour average respiratory exposure should not exceed 0.3 ppm. NIOSH recommends that the short term respiratory exposure to phosphine gas should not exceed 1 ppm. The Immediately Dangerous to Life or Health level is 50 ppm. Overexposure to phosphine gas causes nausea, vomiting, abdominal pain, diarrhea; thirst; chest tightness, dyspnea (breathing difficulty); muscle pain, chills; stupor or syncope; pulmonary edema. Phosphine has been reported to have the odor of decaying fish or garlic at concentrations below 0.3 ppm. The smell is normally restricted to laboratory areas or phosphine processing since the smell comes from the way the phosphine is extracted from the environment. However, it may occur elsewhere, such as in industrial waste landfills. Exposure to higher concentrations may cause olfactory fatigue.

On January 2014, a whole family in Jerusalem was poisoned from phosphine after a section of their apartment was fumigated for pests, and some of the young children died from the poisoning.

---

## 7.6 Antimony Hydride (SbH<sub>3</sub>)

---

Antimony Hydride or stibine is a principal covalent hydride of antimony and a heavy analogue of ammonia. The molecule is pyramidal with H–Sb–H angles of 91.7° and Sb–H distances of 1.707 Å (170.7 pm). This gas has an offensive smell like hydrogen sulfide (rotten eggs).

### Synthesis

SbH<sub>3</sub> is generally prepared by the reaction of Sb<sup>3+</sup> sources with H<sup>–</sup> equivalents:

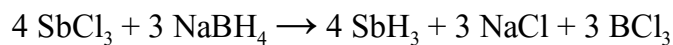
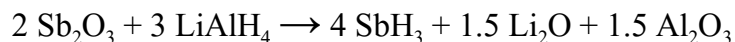

Alternatively, sources of Sb<sup>3+</sup> react with protonic reagents (even water) to also produce this unstable gas:

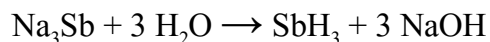

### Properties

The chemical properties of SbH<sub>3</sub> resemble those for AsH<sub>3</sub>. Typical for a heavy hydride (e.g. AsH<sub>3</sub>, H<sub>2</sub>Te, SnH<sub>4</sub>), SbH<sub>3</sub> is unstable with respect to its elements. The gas decomposes slowly at room temperature but rapidly at 200 °C:

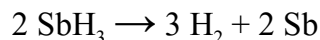

The decomposition is autocatalytic and can be explosive.

SbH<sub>3</sub> is readily oxidized by O<sub>2</sub> or even air:

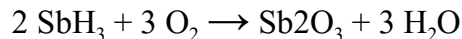

SbH<sub>3</sub> exhibits no basicity, but it can be deprotonated:

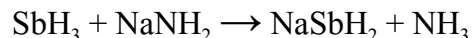

### Applications

It is used in the semiconductor industry to dope silicon with small quantities of antimony via the process of chemical vapour deposition (CVD). It has also been

used as a silicon dopant in epitaxial layers. Reports claim the use of  $\text{SbH}_3$  as a fumigant but its instability and awkward synthesis contrast with the more conventional fumigant phosphine.

### **Safety and Toxicology**

$\text{SbH}_3$  is an unstable flammable gas. It is highly toxic, with an LC50 of 100 ppm in mice. Fortunately,  $\text{SbH}_3$  is so unstable that it is rarely encountered outside of laboratories. The toxicity of stibine is distinct from that of other antimony compounds, but similar to that of arsine. Stibine binds to the haemoglobin of red blood cells, causing them to be destroyed by the body. Most cases of stibine poisoning have been accompanied by arsine poisoning, although animal studies indicate that their toxicities are equivalent. The first signs of exposure, which can take several hours to become apparent, are headaches, vertigo and nausea, followed by the symptoms of hemolytic anemia, hemoglobinuria and nephropathy.

---

## **7.7 Arsenic Hydride ( $\text{AsH}_3$ )**

---

Arsenic Hydride or Arsine is the compound with the formula  $\text{AsH}_3$ . This is flammable, pyrophoric, and highly toxic gas is one of the simplest compounds of arsenic. Despite its lethality, it finds some applications in the semiconductor industry and for the synthesis of organoarsenic compounds. The term arsine is commonly used to describe a class of organoarsenic compounds of the formula  $\text{AsH}_3-x\text{R}_x$ , where R = aryl or alkyl. For example,  $\text{As}(\text{C}_6\text{H}_5)_3$ , called triphenylarsine, which is referred to as "an arsine."

### **Properties**

At standard temperature and pressure, arsine is a colorless, denser-than-air gas that is slightly soluble in water (20% at 20 °C) and in many organic solvents as well. Whereas arsine itself is odorless, due to its oxidation by air it is possible to smell a slight garlic or fish-like smell when the compound is present at above about 0.5 ppm. This compound is generally regarded as stable, since at room temperature it decomposes only slowly. At temperatures of ca. 230 °C decomposition to arsenic and hydrogen is rapid.[citation needed] Several factors, such as humidity, presence

of light and certain catalysts (namely aluminium) facilitate the rate of decomposition. AsH<sub>3</sub> is a pyramidal molecule with H–As–H angles of 91.8° and three equivalent As–H bonds, each of 1.519 Å length.

### **synthesis**

AsH<sub>3</sub> is generally prepared by the reaction of As<sup>3+</sup> sources with H<sup>−</sup> equivalents.

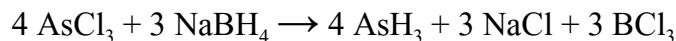

As reported in 1775, Carl Scheele reduced arsenic(III) oxide with zinc in the presence of acid. This reaction is a prelude to the Marsh test, described below.

Alternatively, sources of As<sup>3−</sup> react with protonic reagents to also produce this gas:

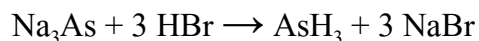
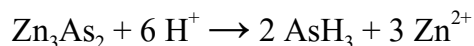

### **Reactions**

Our understanding of the chemical properties of AsH<sub>3</sub> is well developed and can be anticipated based on an average of the behavior of PH<sub>3</sub> and SbH<sub>3</sub>.

### **Thermal decomposition**

Typical for a heavy hydride (e.g., SbH<sub>3</sub>, H<sub>2</sub>Te, SnH<sub>4</sub>), AsH<sub>3</sub> is unstable with respect to its elements. In other words, AsH<sub>3</sub> is stable kinetically but not thermodynamically.

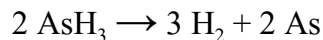

This decomposition reaction is the basis of the Marsh Test described below, which detects the metallic As.

### **Oxidation**

Continuing the analogy to SbH<sub>3</sub>, AsH<sub>3</sub> is readily oxidized by concentrated O<sub>2</sub> or the dilute O<sub>2</sub> concentration in air:

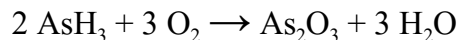

Arsine will react violently in presence of strong oxidizing agents, such as potassium permanganate, sodium hypochlorite or nitric acid.

### **Precursor to metallic derivatives**

AsH<sub>3</sub> is used as a precursor to metal complexes of "naked" (or "nearly naked") As. Illustrative is the dimanganese species [(C<sub>5</sub>H<sub>5</sub>)Mn(CO)<sub>2</sub>]<sub>2</sub>AsH, wherein the Mn<sub>2</sub>AsH core is planar.

### **Gutzeit test**

A characteristic test for arsenic involves the reaction of AsH<sub>3</sub> with Ag<sup>+</sup>, called the Gutzeit test for arsenic.[8] Although this test has become obsolete in analytical chemistry, the underlying reactions further illustrate the affinity of AsH<sub>3</sub> for "soft" metal cations. In the Gutzeit test, AsH<sub>3</sub> is generated by reduction of aqueous arsenic compounds, typically arsenites, with Zn in the presence of H<sub>2</sub>SO<sub>4</sub>. The evolved gaseous AsH<sub>3</sub> is then exposed to AgNO<sub>3</sub> either as powder or as a solution. With solid AgNO<sub>3</sub>, AsH<sub>3</sub> reacts to produce yellow Ag<sub>4</sub>AsNO<sub>3</sub>, whereas AsH<sub>3</sub> reacts with a solution of AgNO<sub>3</sub> to give black Ag<sub>3</sub>As.

### **Acid-base reactions**

The acidic properties of the As–H bond are often exploited. Thus, AsH<sub>3</sub> can be deprotonated:

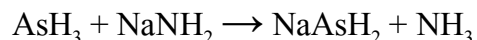

Upon reaction with the aluminium trialkyls, AsH<sub>3</sub> gives the trimeric [R<sub>2</sub>AlAsH<sub>2</sub>]<sub>3</sub>, where R = (CH<sub>3</sub>)<sub>3</sub>C. This reaction is relevant to the mechanism by which GaAs forms from AsH<sub>3</sub> (see below).

AsH<sub>3</sub> is generally considered non-basic, but it can be protonated by superacids to give isolable salts of the tetrahedral species [AsH<sub>4</sub>]<sup>+</sup>.

### **Reaction with halogen compounds**

Reactions of arsine with the halogens (fluorine and chlorine) or some of their compounds, such as nitrogen trichloride, are extremely dangerous and can result in explosions.

## Catenation

In contrast to the behavior of  $\text{PH}_3$ ,  $\text{AsH}_3$  does not form stable chains, although  $\text{H}_2\text{As}-\text{AsH}_2$  and even  $\text{H}_2\text{As}-\text{As}(\text{H})-\text{AsH}_2$  have been detected. The diarsine is unstable above  $-100\text{ }^\circ\text{C}$ .

## Applications

### Microelectronics applications

$\text{AsH}_3$  is used in the synthesis of semiconducting materials related to microelectronics and solid-state lasers. Related to Phosphorus, Arsenic is an n-dopant for silicon and germanium. More importantly,  $\text{AsH}_3$  is used to make the semiconductor GaAs by chemical vapor deposition (CVD) at  $700\text{--}900\text{ }^\circ\text{C}$ :

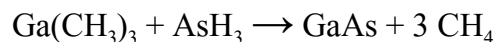

For microelectronic applications, arsine can be provided via a sub-atmospheric gas source. In this type of gas package, the arsine is adsorbed on a solid microporous adsorbent inside a gas cylinder. This method allows the gas to be stored without pressure, significantly reducing the risk of an arsine gas leak from the cylinder. With this apparatus, arsine is obtained by applying vacuum to the gas cylinder valve outlet. For semiconductor manufacturing, this method is practical as these processes usually operate under high vacuum.

### Chemical warfare

Since before WWII  $\text{AsH}_3$  was proposed as a possible chemical warfare weapon. The gas is colorless, almost odorless, and 2.5 times denser than air, as required for a blanketing effect sought in chemical warfare. It is also lethal in concentrations far lower than those required to smell its garlic-like scent. In spite of these characteristics, arsine was never officially used as a weapon, because of its high flammability and its lower efficacy when compared to the non-flammable alternative phosgene. On the other hand, several organic compounds based on arsine, such as lewisite ( $\beta$ -chlorovinylchloroarsine), adamsite (diphenylaminechloroarsine), Clark I (diphenylchloroarsine) and Clark II

(diphenylcyanoarsine) have been effectively developed for use in chemical warfare.

### **Forensic science and the Marsh test**

AsH<sub>3</sub> is also well known in forensic science because it is a chemical intermediate in the detection of arsenic poisoning. The old (but extremely sensitive) Marsh test generates AsH<sub>3</sub> in the presence of arsenic.[1] This procedure, developed around 1836 by James Marsh, is based upon treating an As-containing sample of a victim's body (typically the stomach) with As-free zinc and dilute sulfuric acid: if the sample contains arsenic, gaseous arsine will form. The gas is swept into a glass tube and decomposed by means of heating around 250–300 °C. The presence of As is indicated by formation of a deposit in the heated part of the equipment. On the other hand, the appearance of a black mirror deposit in the cool part of the equipment indicates the presence of antimony (the highly unstable SbH<sub>3</sub> decomposes even at low temperatures).

The Marsh test was widely used by the end of the 19th century and the start of the 20th; nowadays more sophisticated techniques such as atomic spectroscopy, inductively coupled plasma and x-ray fluorescence analysis are employed in the forensic field. Though neutron activation analysis was used to detect trace levels of arsenic in the mid 20th century it has fallen out of use in modern forensics.

### **Toxicology**

The toxicity of arsine is distinct from that of other arsenic compounds. The main route of exposure is by inhalation, although poisoning after skin contact has also been described. Arsine attacks haemoglobin in the red blood cells, causing them to be destroyed by the body.

The first signs of exposure, which can take several hours to become apparent, are headaches, vertigo and nausea, followed by the symptoms of haemolytic anaemia (high levels of unconjugated bilirubin), haemoglobinuria and nephropathy. In severe cases, the damage to the kidneys can be long-lasting.

Exposure to arsine concentrations of 250 ppm is rapidly fatal: concentrations of 25–30 ppm are fatal for 30 min exposure, and concentrations of 10 ppm can be



fatal at longer exposure times. Symptoms of poisoning appear after exposure to concentrations of 0.5 ppm. There is little information on the chronic toxicity of arsine, although it is reasonable to assume that, in common with other arsenic compounds, a long-term exposure could lead to arsenicosis

---

## 7.8 Selenides

---

Hydrogen selenide is an inorganic compound with the formula  $\text{H}_2\text{Se}$ . It is the simplest (and virtually the only) hydride of selenium.  $\text{H}_2\text{Se}$  is a colorless, flammable gas under standard conditions. It is the most toxic selenium compound with an exposure limit of 0.05 ppm over an 8 hour period. This compound has a very irritating smell resembling that of decayed horseradish but smells of rotten eggs at higher concentrations.  $\text{H}_2\text{Se}$  adopts a "bent" structure with a H-Se-H bond angle of  $91^\circ$ . Consistent with this structure, three IR-active vibrational bands are observed: 2358, 2345, and  $1034\text{ cm}^{-1}$ .

The properties of  $\text{H}_2\text{S}$  and  $\text{H}_2\text{Se}$  are similar, although the selenide is more acidic with  $\text{p}K_{\text{a}} = 3.89$ , and the second  $\text{p}K_{\text{a}} = 11.0$  at  $25^\circ\text{C}$ . Reflecting its acidity,  $\text{H}_2\text{Se}$  is soluble in water.

Industrially, it is produced by treating elemental selenium at  $T > 300^\circ\text{C}$  with hydrogen gas. A number of routes to  $\text{H}_2\text{Se}$  have been reported, which are suitable for both large and small scale synthesis. In the laboratory,  $\text{H}_2\text{Se}$  is usually prepared by the action of water on  $\text{Al}_2\text{Se}_3$ , concomitant with formation of hydrated alumina. A related reaction involves the acid hydrolysis of  $\text{FeSe}$ .

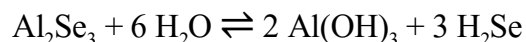

$\text{H}_2\text{Se}$  can also be prepared by means of different methods based on the *in situ* generation in aqueous solution using boron hydride, Marsh test and Devarda's alloy. According to the Sonoda method,  $\text{H}_2\text{Se}$  is generated from the reaction of  $\text{H}_2\text{O}$  and  $\text{CO}$  on  $\text{Se}$  in the presence of  $\text{Et}_3\text{N}$ .  $\text{H}_2\text{Se}$  can be purchased in cylinders.

Elemental selenium can be recovered from  $\text{H}_2\text{Se}$  through a reaction with aqueous sulfur dioxide ( $\text{SO}_2$ ).

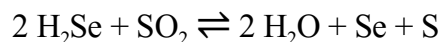

Its decomposition is used to prepare highly pure Se metal.  $\text{H}_2\text{Se}$  is commonly used in the synthesis of Se-containing compounds. It adds across alkenes.

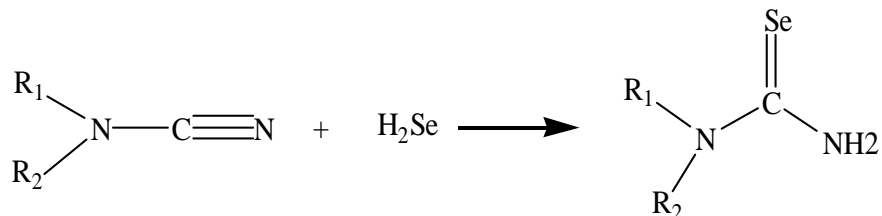

$\text{H}_2\text{Se}$  gas is used to dope semiconductors with selenium. Hydrogen selenide is hazardous, being the most toxic selenium compound and far more toxic than its congener hydrogen sulfide. The threshold limit value is 0.05 ppm. The gas acts as an irritant at concentrations higher than 0.3 ppm, which is the main warning sign of exposure; below 1 ppm, this is "insufficient to prevent exposure", while at 1.5 ppm the irritation is "intolerable". Exposure at high concentrations, even for less than a minute, causes the gas to attack the eyes and mucous membranes; this causes cold-like symptoms for at least a few days afterwards. In Germany, the limit in drinking water is 0.008 mg/L, and the US EPA recommends a maximum contamination of 0.01 mg/L. Despite being highly toxic, no human fatalities have yet been reported. It is suspected that this is due to the gas' tendency to oxidise to form red selenium in mucous membranes; elemental selenium is less toxic than selenides are.

## 7.9 Tellurides

Hydrogen telluride (tellurane) is the compound with the formula  $\text{H}_2\text{Te}$ . The simplest hydride of tellurium, it is rarely encountered because it decomposes rapidly to the constituent elements. However, the gas can exist at very low concentrations long enough to be readily detected by the smell of rotting garlic or rotting leeks. Most compounds with Te-H bonds (tellurols) are unstable with respect to loss of  $\text{H}_2$ .  $\text{H}_2\text{Te}$  is chemically and structurally similar to hydrogen selenide, both are acidic. The H-Te-H angle is about  $90^\circ$ . Volatile tellurium compounds often have unpleasant odours, reminiscent of decayed leeks or garlic.

H<sub>2</sub>Te is synthesized by the acidification of salts of Te<sup>2-</sup>, such as Al<sub>2</sub>Te<sub>3</sub> and Na<sub>2</sub>Te. Na<sub>2</sub>Te can be generated by the reaction of Na and Te in anhydrous ammonia. The intermediate in the acidification, HTe<sup>-</sup>, is a stable anion. Sodium hydrogen telluride, NaHTe, can be made by reducing tellurium with NaBH<sub>4</sub>.

Tellurium hydrides is usually prepared in the laboratory by hydrolysis of the telluride derivatives of electropositive metals. Typical is the hydrolysis of aluminum telluride:

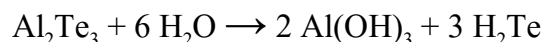

Magnesium and alkali metal tellurides can also be hydrolyzed. Usually these procedures require acid since the H<sub>2</sub>Te is rather acidic. Electrolytic methods have been developed.<sup>1</sup>

H<sub>2</sub>Te is an endothermic compound, unstable in air and easily oxidised to water and elemental tellurium:

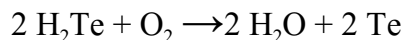

It is almost as acidic as phosphoric acid ( $K_a = 8.1 \times 10^{-3}$ ), having a  $K_a$  value of about  $2.3 \times 10^{-3}$ . It reacts with many metals to form tellurides.

---

## 7.10 Summery

---

The above unit deeply and simply explains about the hydrogen and its compounds. The Hydrogen is a chemical element which is denoted by symbol H and atomic number 1. With an atomic weight of 1.00794 u, hydrogen is the lightest element on the periodic table. Hydrogen can form compounds with elements that are more electronegative, such as halogens (e.g., F, Cl, Br, I), or oxygen; in these compounds hydrogen takes on a partial positive charge. When bonded to fluorine, oxygen, or nitrogen, hydrogen can participate in a form of medium-strength noncovalent bonding called hydrogen bonding, which is critical to the stability of many biological molecules. Hydrides are the compounds of any element containing hydrogen. these have been classified into three main types according to the nature of their bonding -Ionic hydrides, Covalent hydrides, Interstitial hydrides. The

simple explanation about important hydrides like selenide, telluride, stibine, arsenide, etc are given.

---

### **7.11 Review Question**

---

1. What is hydrogen and its compounds? Explain.
  2. Give the classification of hydrides.
  3. Give the synthesis of any three hydrides.
  4. Give the different applications of phosphine and arsenic hydride.
  5. What are tellurides and selenides? Explain.
- 

### **7.12 Reference and Suggested readings**

---

- 1 Concise Inorganic chemistry- J.D. Lee (Blackwell Science) 2001
- 2 Inorganic Chemistry- F.A. Cotton (Interscience publisher) 2008

---

## Unit - 8 : Alkali & alkaline earth metals

---

### Structure of Unit

- 8.0 Objectives
- 8.1 Introduction
- 8.2 Alkali Metals:
- 8.3 Physical properties:
- 8.4 Chemical properties:
- 8.5 Alkali Earth Metals
- 8.6 Chemical properties:
- 8.8 Crown ethers:
- 8.9 Summary
- 8.10 Review Questions
- 8.11 References and Suggested Readings

---

### 8.0 Objectives

---

This unit deals with the alkali and alkali earth metals. Alkali metals are very important for us, moreover, Sodium and potassium are very common alkali metals. These elements are essential for the existence of all known life. They are found in the cytoplasm (organic fluid, mainly water) of all living cells, and they are critical to everyday cell operation and regulation. Also, a common sodium salt, sodium chloride (table salt), has been identified many times as a contributor to hypertension in humans. A double-blind, two-month study was conducted on a group of elderly adults by modestly cutting their salt intake, to find if cutting salt intake would lower blood pressure. Some in the group were given half the salt that others were given for the duration of the study. The findings indicated that those who were given only half the amount of salt experienced a drop in blood pressure of up to 7.2 mm Hg.

---

## 8.1 Introduction

---

This unit deals with the following topics

- General introduction of the alkali metals.
- Physical and chemical properties of alkali metals.
- General introduction of the alkali earth metals.
- Physical and chemical properties of alkali earth metals.
- Crown ethers, their synthesis and properties.

---

## 8.2 Alkali Metals:

---

The group 1 of the periodic table contains six elements, namely lithium (Li), sodium (Na), potassium (K), rubidium (Rb), caesium (Cs) and francium (Fr). All these elements are typical metals. These are usually referred to as alkali metals since their hydroxides forms strong bases or alkalies.

Group I metals	Symbol	Atomic number	Electronic structure
Lithium	Li	3	[He]2s <sup>1</sup>
Sodium	Na	11	[Ne]3s <sup>1</sup>
Potassium	K	19	[Ar]4s <sup>1</sup>
Rubidium	Rb	37	[Kr]5s <sup>1</sup>
Caesium	Cs	55	[Xe]6s <sup>1</sup>
Francium	Fr	87	[Rn]7s <sup>1</sup>

Of all the alkali metals, only sodium and potassium are found in abundance in nature. Francium occurs only in minute quantities as a radioactive decay product.

The alkali metals have very similar properties: they are all shiny, soft, highly reactive metals at standard temperature and pressure and readily lose their outermost electron to form cations with charge +1. They can all be cut easily with a knife due to their softness, exposing a shiny surface that tarnishes rapidly in air due to oxidation. Because of their high reactivity, they must be stored under oil to prevent reaction with air, and are found naturally only in salts and never as the free element. In the modern IUPAC nomenclature, the alkali metals comprise the group 1 elements, excluding hydrogen (H), which is nominally a group 1 element but not normally considered to be an alkali metal as it rarely exhibits behaviour comparable to that of the alkali metals. All the alkali metals react with water, with the heavier alkali metals reacting more vigorously than the lighter ones.

All the discovered alkali metals occur in nature: in order of abundance, sodium is the most abundant, followed by potassium, lithium, rubidium, caesium, and finally francium, which is very rare due to its extremely high radioactivity and thus occurs only in traces due to its presence in natural decay chains. Experiments have been conducted to attempt the synthesis of ununennium (Uue), which is likely to be the next member of the group, but they have all met with failure. However, ununennium may not be an alkali metal due to relativistic effects, which are predicted to have a large influence on the chemical properties of superheavy elements; even if it does turn out to be an alkali metal, it is predicted to have some differences in physical and chemical properties from its lighter homologues.

Most alkali metals have many different applications. Two of the most well-known applications of the pure elements are rubidium and caesium atomic clocks, of which caesium atomic clocks are the most accurate and precise representation of time. A common application of the compounds of sodium is the sodium-vapour lamp, which emits very efficient light. Table salt, or sodium chloride, has been used since antiquity. Sodium and potassium are also essential elements, having major biological roles as electrolytes, and although the other alkali metals are not essential, they also have various effects on the body, both beneficial and harmful.

---

### 8.3 Physical properties:

---

1. All are silvery white, soft and light solids. These can be cut with the help of knife. When freshly cut, they have bright lustre which quickly tarnishes due to surface oxidation.
2. These form diamagnetic colourless ions since these ions do not have unpaired electrons, (i.e.  $M^+$  has  $ns^0$  configuration). That is why alkali metal salts are colourless and diamagnetic.
3. The alkali metals have largest atomic and ionic radii than their successive elements of other groups belonging to same period. The atomic and ionic radii of alkali metals, however, increases down the group due to progressive addition of new energy shells.

	Li	Na	K	Rb	Cs	Fr
Atomic radius (pm)	152	186	227	248	265	375
Ionic radius of $M^+$ ions (pm)	60	95	133	148	169	–

4. All metals are light in weight, *Li*, *Na* and *K* have density less than water.
5. All these elements possess low melting and boiling point in comparison to other group members.
6. Due to unpaired lone electron in  $ns$  sub-shell as well as due to their larger size, the outermost electron is far from the nucleus, the removal of electron is easier and these low values of ionisation energy (*I.E.*) Ionisation energy of these metal decreases from *Li* to *Cs*. Due to their strong electropositive character, they emit electrons even when exposed to light showing photoelectric effect. This property is responsible for the use of *Cs* and *K* in photoelectric cell.



7. These elements easily form univalent +ve ion by losing solitary  $ns^1$  electron due to low ionisation energy values. Alkali metals are univalent in nature and form ionic compounds. Lithium salts are, however, covalent.
8. Hydration represents for the dissolution of a substance in water to get adsorb water molecule by weak valency force. Hydration of ions is the exothermic process when ions on dissolution water get hydration. Smaller the cation, greater is the degree of hydration. Hydration energy,  $Li^+ > Na^+ > K^+ > Rb^+ > Cs^+$ .
9. These metals are highly electropositive and thereby possess low values of electronegativities. Electronegativity of alkali metals decreases down the group as the trend of numerical values of electronegativity given below on Pauling scale suggests.
10. Specific heat decreases from Li to Cs.
11. All alkali metals are good conductors of heat & electricity, because of loosely held valence electrons.
12. Alkali metals and their salts give characteristic colour to Bunsen flame. The flame energy causes and excitation of the outermost electron which on reverting back to its initial position gives out the absorbed energy as visible light. These colour differ from each other Li –crimson, Na–Golden yellow, K – Pale violet , Rb and Cs– violet. These different colours are due to the variation in the ionisation energy of alkali metals. The energy released is minimum in the case of  $Li^+$  and increases in the order.

---

## 8.4 Chemical properties:

---

1. Reaction with oxygen: The elements of Group I are called alkali metals because they react with water to form alkaline solutions. They are very reactive and have to be stored under paraffin oil to protect them from air and moisture. The alkali metals have low first ionization enthalpies and form ions easily by losing one electron thereby forming a univalent ion with a noble gas like structure. They react readily with water, dilute acids and most non-metals. The order of the reactivity of the elements is :



With the exception of lithium and beryllium, all s-block elements produce more than one oxide. The three types of oxides are all ionic, and the ions are related as follows :

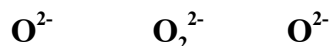

Lithium will melt when heated and eventually burns to form the monoxide and some lithium nitride :

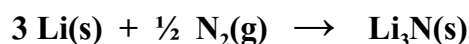
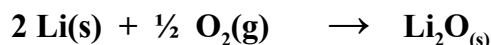

Sodium burns in air with a yellow flame. The white product remaining is not pure sodium oxide. In fact, it is mainly sodium peroxide :

Potassium, rubidium and caesium ignite spontaneously to form peroxides and superoxides.

2. Reaction with water: The reactivity of alkali metals increases markedly down the group. Lithium reacts quietly or very slowly with water. Sodium reacts vigorously with water. Potassium reacts so vigorously with water that the hydrogen formed catches fire because sufficient heat is generated in the reaction between potassium and water to ignite the hydrogen. Both rubidium and caesium react explosively.

Types of oxides	Elements which form oxides directly in the adequate supply of air
Monoxide, $O^{2-}$	Li Be Mg Ca Sr Ba
Peroxide, $O_2^{2-}$	Na
Superoxide, $O_2^-$	K Rb Cs

All alkali metal oxides are basic oxides and thus react with water to form hydroxides, and with acids to form salts and water.

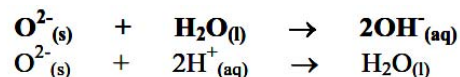

Alkali metal oxides are decomposed by cold water. They react with acid readily and have no reaction with alkalis.

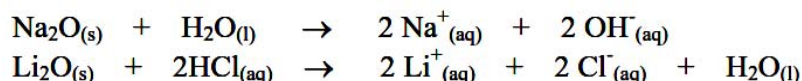

**Extraction:** Alkali metals cannot be extracted by the usual methods for the extraction of metals due to following reasons.

(i) Alkali metals are strong reducing agents, hence cannot be extracted by reduction of their oxides or other compounds.

(ii) Being highly electropositive in nature, it is not possible to apply the method of displacing them from their salt solutions by any other element.

(iii) The aqueous solutions of their salts cannot be used for extraction by electrolytic method because hydrogen ion is discharged at cathode instead of an alkali metal ions as the discharge potentials of alkali metals are high. However, by using Hg as cathode, alkali metal can be deposited.

**Alloy formation:** The alkali metals form alloys among themselves as well as with other metals. Alkali metals also get dissolved in mercury to form amalgam with evolution of heat and the amalgamation is highly exothermic

**Oxides:** These are most reactive metals and have strong affinity for  $\text{O}_2$  quickly tranish in air due to the formation of a film of their oxides on the surface. These are, therefore, kept under kerosene or paraffin oil to protect them from air,

When burnt air ( $\text{O}_2$ ), lithium forms lithium oxide ( $\text{Li}_2\text{O}$ ) sodium forms sodium peroxide ( $\text{Na}_2\text{O}_2$ ) and other alkali metals form super oxide ( $\text{MO}_2$  i.e.  $\text{KO}_2, \text{RbO}_2$  or  $\text{CsO}_2$ ). The reactivity of alkali metals towards oxygen to form different oxides is due to strong positive field around each alkali metal cation.  $\text{Li}^+$  being smallest, possesses strong positive field and thus combines with small anion  $\text{O}^{2-}$  to form

stable  $\text{Li}_2\text{O}$  compound. The  $\text{Na}^+$  and  $\text{K}^+$  being relatively larger thus exert less strong positive field around them and thus reacts with larger oxygen anion i.e  $\text{O}_2^{2-}$  and  $\text{O}_2^{1-}$ , to form stable oxides.

The oxides of alkali metals and metal itself give strongly alkaline solution in water with evolution of heat

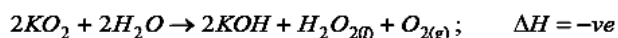
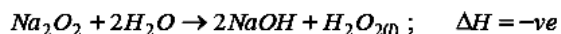
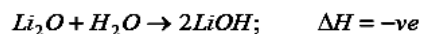
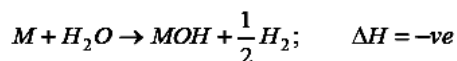

The reactivity of alkali metals towards air and water increases from Li to Cs that is why lithium decomposes  $\text{H}_2\text{O}$  very slowly at  $25^\circ\text{C}$  whereas Na does so vigorously, K reacts producing a flame and Rb, Cs do so explosively.

**Hydrides:** These metal combines H to give white crystalline ionic hydrides of the general of the formula MH. The tendency to form their hydrides, basic character and stability decreases from Li to Cs since the electropositive character decreases from Cs to Li. Reactivity towards  $\text{H}_2$  is



**Carbonates and Bicarbonates:** The carbonates ( $\text{M}_2\text{CO}_3$ ) & bicarbonates ( $\text{MHCO}_3$ ) are highly stable to heat, where M stands for alkali metals. The stability of these salts increases with the increasing electropositive character from Li to Cs.

**Halides:** Alkali metals combine directly with halogens to form ionic halide  $\text{M}^+\text{X}^-$ . The ease with which the alkali metals form halides increases from Li to Cs due to increasing electropositive character from Li to Cs.

Lithium halides however have more covalent nature. Smaller is the cation, more is deformation of anion and thus more is covalent nature in compound. Also among lithium halides, lithium iodide has maximum covalent nature because of larger anion which is easily deformed by a cation (The Fajan's rule) Thus covalent character in lithium halides is,  $\text{LiI} > \text{LiBr} > \text{LiCl} > \text{LiF}$

Solubility in liquid  $\text{NH}_3$  : These metals dissolve in liquid  $\text{NH}_3$  to produce blue coloured solution, which conducts electricity to an appreciable degree. With increasing concentration of ammonia, blue colour starts changing to that of metallic copper after which dissolution of alkali metals in  $\text{NH}_3$  ceases.

**Nitrates and sulphates:** Nitrates of alkali metals ( $\text{MNO}_3$ ) are soluble in water and decompose on heating.  $\text{LiNO}_3$  decomposes to give  $\text{NO}_2$  and  $\text{O}_2$  and rest all give nitrites and oxygen.

Alkali metals' sulphate have the formula  $\text{M}_2\text{SO}_4$  . Except  $\text{Li}_2\text{SO}_4$ , rest all are soluble water. The sulphates of alkali metals (except Li) form double salts with the sulphate of the trivalent metals like Fe, Al, Cr etc. The double sulphates crystallize with large number of water molecules as alum. e.g.  $\text{K}_2\text{SO}_4 \cdot \text{Al}_2(\text{SO}_4)_3 \cdot 24 \text{H}_2\text{O}$  .

**Complex ion formation :** A metal forms complex only when it possesses the following characteristics, (i) Small size (ii) High nuclear charge (iii) Presence of empty orbitals in order to accept electron pair ligand. Only Lithium in alkali metals due to small size forms a few complex ions Rest all alkali metals do not possess the tendency to form complex ion.

**Diagonal Relationship of Li with Mg:** Due to its small size lithium differs from other alkali metals but resembles with Mg as its size is closer to Mg Its resemblance with Mg is known as diagonal relationship. Generally the periodic properties show either increasing or decreasing trend along the group and vice versa along the period which brought the diagonally situated elements to closer values. Following are the characteristic to be noted.

- (1) Both Li and Mg are harder and higher m.pt than the other metals of their groups.
- (2) Due to covalent nature, chlorides of both Li and Mg are deliquescent and soluble in alcohol and pyridine while chlorides of other alkali metals are not so.
- (3) Fluorides, phosphates of li and Mg are sparingly soluble in water whereas those of other alkali metals are soluble in water.
- (4) Carbonates of Li and Mg decompose on heating and liberate  $\text{CO}_2$  Carbonates of other alkali metals are stable towards heat and decomposed only on fusion.

---

## 8.5 Alkali Earth Metals

---

Alkaline earth metals are grey metals and are harder than alkali metals, although they can still be cut with a knife. The lower member barium is very soft, and it tarnishes rapidly. Metallic bond among atoms is stronger than their Group I counterparts; and the melting points and boiling points of the elements are all higher, as a result of the effect of increased core charge (+2) and decreased atomic radius. Beryllium and magnesium have hexagonal close packed structures, while calcium and strontium have face-centred cubic close packed structures. The more efficient packing of the atoms accounts for the higher density of alkaline earth metals.

All s-block elements have low electronegativity values, i.e., they are electropositive, with a tendency to lose their outer electrons relatively easily. As each group is descended, the elements become more and more electropositive than the elements tend to lose electrons more readily. This is because the outer shell is further from the nucleus as each group is descended. Group II elements are more electronegative (less electropositive) than Group I elements in the same period, as the nuclear charge has increased by one.

Group II metals	Symbol	Atomic number	Electronic structure
Beryllium	Be	4	[He]2s <sup>1</sup>
Magnesium	Mg	12	[Ne]3s <sup>1</sup>
Calcium	Ca	20	[Ar]4s <sup>1</sup>
Strontium	Sr	38	[Kr]5s <sup>1</sup>
Barium	Ba	56	[Xe]6s <sup>1</sup>
Radium	Ra	88	[Rn]7s <sup>1</sup>

**Physical propertie:**

1. All are greyish-white, light, malleable and ductile metals with metallic lustre. Their hardness progressively decrease with increase in atomic number. Although these are fairly soft but relatively harder than alkali metals.
2. The atomic and ionic radii of alkaline earth metals also increase down the group due to progressive addition of new energy shells like alkali metals.

	Be	Mg	Ca	Sr	Ba	Ra
Atomic radius (pm)	112	160	197	215	222	–
Ionic radius of $M^{2+}$ ion (pm)	31	65	99	113	135	140

3. Density decreases slightly upto Ca after which it increases. The decrease in density from Be to Ca might be due to less packing of atoms in solid lattice of Mg and Ca.

Be	Mg	Ca	Sr	Ba	Ra
1.84	1.74	1.55	2.54	3.75	6.00

The alkaline earth metals are more denser, heavier and harder than alkali metal. The higher density of alkaline earth metals is due to their smaller atomic size and strong intermetallic bonds which provide a more close packing in crystal lattice as compared to alkali metals.

4. Melting points and boiling points of alkaline earth metals do not show any regular trend.

	Be	Mg	Ca	Sr	Ba	Ra
M pt. (K)	1560	920	1112	1041	1000	973
B.pt (K)	2770	1378	1767	1654	1413	–

The values are, however, more than alkali metals. This might be due to close packing of atoms in crystal lattice in alkaline earth metals.

5. Ionization energy and electropositive or metallic character: Since the atomic size decreases along the period and the nuclear charge increases and thus the electrons are more tightly held towards nucleus. It is therefore alkaline earth metals have higher ionization energy in comparison to alkali metals but lower ionization energies in comparison to p-block elements.

	Be	Mg	Ca	Sr	Ba	Ra
1 <sup>st</sup> ionization energy (kJ/mol)	899	737	590	549	503	509
2 <sup>nd</sup> ionization energy (kJ/mol)	1757	1450	1146	1064	965	979

The higher values of second ionization energy is due to the fact that removal of one electron from the valence shell, the remaining electrons are more tightly held in which nucleus of cation and thus more energy is required to pull one more electron from monovalent cation.

6. Oxidation number and valency : The IE1 of these metals are much lower than IE1 and thus it appears that these metals should form univalent ion rather than divalent ions but in actual practice, all these give bivalent ions. This is due to the



fact that  $M^{2+}$  ion possesses a higher degree of hydration or  $M^{2+}$  ions are extensively hydrated to form  $[M(H_2O)_x]^{2+}$ , a hydrated ion. This involves a large amount of energy evolution which counter balances the higher value of second ionization energy.

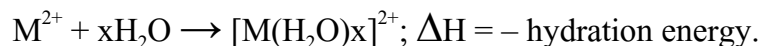

The tendency of these metals to exist as divalent cation can thus be accounted as,

Divalent cation of these metals possess noble gas or stable configuration. The formation of divalent cation lattice leads to evolution of energy due to strong lattice structure of divalent cation which easily compensates for the higher values of second ionization energy of these metals.

7. Electronegativities: The electronegativities of alkaline earth metals are also small but are higher than alkali metals. Electronegativity decreases from Be to Ba as shown below,

	Be	Mg	Ca	Sr	Ba
Electronegativity	1.57	1.31	1.00	0.95	0.89

Alkali earth metals are good conductor of heat and electricity.

8. Characteristic flame colours: The characteristic flame colour shown are : Ca-brick red; Sr –crimson ; Ba-apple green and Ra- crimson. Alkaline earth metals except Be and Mg produce characteristic colour to flame due to easy excitation of electrons to higher energy levels. Be and Mg atoms due to their small size, bind their electrons more strongly (because of higher effective nuclear charge) Hence these requires high excitation energy and are not excited by the energy of flame with the result that no flame colour is shown by them.

---

## 8.6 Chemical properties:

---

1. Occurrence: These are found mainly in combined state such as oxides, carbonates and sulphates Mg and Ca are found in abundance in nature. Be is not very abundant, Sr and Ba are less abundant. Ra is rare element. Some important ores of alkaline earth metals are given below,
  - (i) Beryllium : Beryl ( $3\text{BeO}\cdot\text{Al}_2\text{O}_3\cdot 6\text{SiO}_2$ )
  - (ii) Magnesium: Magnesite ( $\text{MgCO}_3$ ); Dolomite ( $\text{CaCO}_3, \text{MgCO}_3$ );
  - (iii) Calcium: Limestone ( $\text{CaCO}_3$ ); Gypsum : ( $\text{CaSO}_4\cdot 2\text{H}_2\text{O}$ ),
  - (iv) Barium: Barytes ( $\text{BaSO}_4$ ) ;
  - (v) Radium: Pitch blende ( $\text{U}_3\text{O}_8$ );
2. Formation of oxides and hydroxides: The elements (except Ba and Ra) when burnt in air give oxides of ionic nature  $\text{M}^{2+}\text{O}^{2-}$  which are crystalline in nature . Ba and Ra however give peroxide. The tendency to form higher oxides increases from Be to Ra.

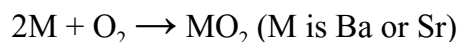
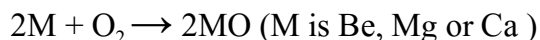

Their less reactivity than the alkali metals is evident by the fact that they are slowly oxidized on exposure to air; however the reactivity of these metals towards oxygen increases on moving down the group.

The oxides of the metal (except BeO and MgO) dissolve in water to form basic hydroxides and evolve a large amount of heat. BeO and MgO possess high lattice energy and thus insoluble in water.

The basic nature of oxides of alkaline earth metals increases from Be to Ra as the electropositive Character increases from Be to Ra. The tendency of these metal to react with water increases with increase in electropositive character i.e. Be to Ra.

3. Hydrides: Except Be, all alkaline earth metals form hydrides ( $\text{MH}_2$ ) on heating directly with  $\text{H}_2$  .

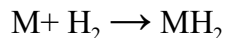

BeH<sub>2</sub> is prepared by the action of LiAlH<sub>4</sub> on BeCl<sub>2</sub>;

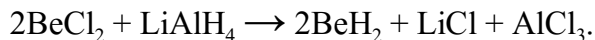

BeH<sub>2</sub> and MgH<sub>2</sub> are covalent while other hydrides are ionic. The stability of hydrides decreases from Be to Ba.

The hydrides having higher reactivity for water, dissolve readily and produce hydrogen gas.

4. Carbonates and Bicarbonates: All these metal carbonates (MCO<sub>3</sub>) are insoluble in neutral medium but soluble in acid medium. These are precipitated by the addition of alkali metal or ammonium carbonate solution to the solution of these metals.

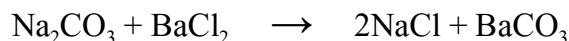
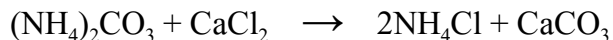

Alkaline earth metal carbonates are obtained as white precipitates when a calculated amount of carbon dioxide is passed through the solution of the alkaline metal hydroxides.

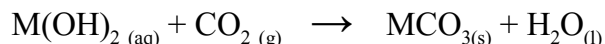

and sodium or ammonium carbonate is added to the solution of the alkaline earth metal salt such as CaCl<sub>2</sub>.

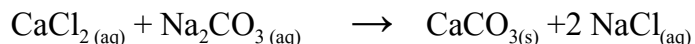

Solubility of carbonates of these metals also decreases downward in the group due to the decrease of hydration energy as the lattice energy remains almost unchanged as in case of sulphates.

5. Solubility in liquid ammonia: Like alkali metals, alkaline earth metals also dissolve in liquid ammonia to form coloured solutions. When such a solution is evaporated, hexammine, M(NH<sub>3</sub>)<sub>6</sub> is formed.

6. Nitrates and sulphates: All the alkaline earth metals directly combine with  $N_2$  give nitrides,  $M_3N_2$ . The ease of formation of nitrides however increases from Be to Ba. These nitrides are hydrolyzed with water to liberate  $NH_3$ .

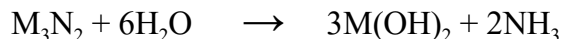

All these form sulphate of the type  $MSO_4$  by the action of  $H_2SO_4$  on metals, their oxides, carbonates or hydroxides.

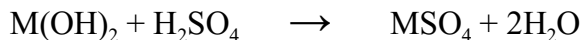
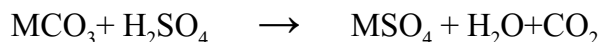
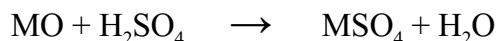
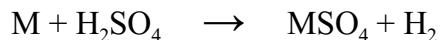

The solubility of sulphates in water decreases on moving down the group  $BeSO_4$  and  $MgSO_4$  are fairly soluble in water while  $BaSO_4$  is completely insoluble. This is due to increases in lattice energy of sulphates down the group which predominates over hydration energy. Sulphates are quite stable to heat however reduced to sulphide on heating with carbon.

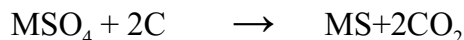

7. Formation of complexes: Tendency to show complex ion formation depends upon smaller size, high nuclear charge and vacant orbitals to accept electron. Since alkaline earth metals do not possess these characteristics and thus are unable to form complex ion. However,  $Be^{2+}$  on account of smaller size forms many complexes such as  $(BeF_3)^-$ ,  $(BeF_4)^{2-}$ .
8. Diagonal relationship of Be with Al: Due to its small size Be differs from other alkaline earth metals but resembles in many of its properties with Al on account of diagonal relationship.
- (1)  $Be^{2+}$  and  $Al^{3+}$  have almost same smaller size and thus favour for covalent bonding.
- (2) Both these form covalent compounds having low m. pt and soluble in

organic solvent.

(3) Both have same value of electronegativity (i.e. 1.5).

(4) The standard O.P of these elements are quite close to each other



(5) Both become passive on treating with conc.  $\text{HNO}_3$  in cold.

(6) Both form many stable complexes e.g.  $(\text{BeF}_3)^-$ ,  $(\text{AlH}_4)^-$ .

---

## 8.8 Crown ethers:

---

Crown ethers are cyclic chemical compounds that consist of a ring containing several ether groups. The most common crown ethers are oligomers of ethylene oxide, the repeating unit being ethyleneoxy, i.e.,  $-\text{CH}_2\text{CH}_2\text{O}-$ . Important members of this series are the tetramer ( $n = 4$ ), the pentamer ( $n = 5$ ), and the hexamer ( $n = 6$ ). The term "crown" refers to the resemblance between the structure of a crown ether bound to a cation, and a crown sitting on a person's head. The first number in a crown ether's name refers to the number of atoms in the cycle, and the second number refers to the number of those atoms that are oxygen. Crown ethers are much broader than the oligomers of ethylene oxide; an important group are derived from catechol.

Crown ethers strongly bind certain cations, forming complexes. The oxygen atoms are well situated to coordinate with a cation located at the interior of the ring, whereas the exterior of the ring is hydrophobic. The resulting cations often form salts that are soluble in nonpolar solvents, and for this reason crown ethers are useful in phase transfer catalysis. The denticity of the polyether influences the affinity of the crown ether for various cations. For example, 18-crown-6 has high affinity for potassium cation, 15-crown-5 for sodium cation, and 12-crown-4 for lithium cation. The high affinity of 18-crown-6 for potassium ions contributes to its toxicity. Crown ethers are not the only macrocyclic ligands that have affinity for the potassium cation. Ionophores such as valinomycin also display a marked preference for the potassium cation over other cations.

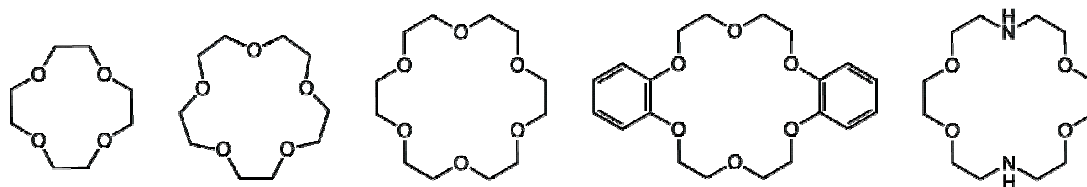
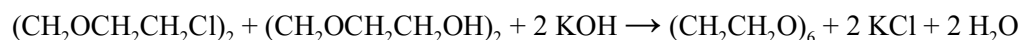

Figure: Structures of common crown ethers: 12-crown-4, 15-crown-5, 18-crown-6, dibenzo-18-crown-6, and diaza-18-crown-6

Synthesis: This compound is prepared by a modified Williamson ether synthesis in the presence of a templating cation. It can be also prepared by the oligomerization of ethylene oxide



It can be purified by distillation, where its tendency to supercool becomes evident. 18-Crown-6 can also be purified by recrystallisation from hotacetonitrile. It initially forms an insoluble solvate. Rigorously dry material can be made by dissolving the compound in THF followed by the addition of NaK to give  $[\text{K}(18\text{-crown-6})]\text{Na}$ , an alkali salt. Crystallographic analysis reveals a relatively flat molecule but one where the oxygen centres are not oriented in the idealized 6-fold symmetric geometry usually shown. The molecule undergoes significant conformational change upon complexation.

Application: Crown ethers are used in the laboratory as phase transfer catalysts. In general however it is not widely used; cheaper and more versatile phase transfer catalysts are known. In the presence of 18-crown-6, potassium permanganate dissolves in benzene giving the so-called "purple benzene", which can be used to oxidize diverse organic compounds.

Various substitution reactions are also accelerated in the presence of 18-crown-6, which suppresses ion-pairing. The anions thereby become naked nucleophiles. For example, using 18-crown-6, potassium acetate is a more powerful nucleophile in organic solvents

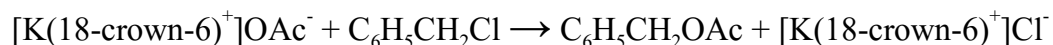

The first electroneutral salt using 18-crown-6 that has been synthesized and examined with X-ray crystallography is  $[\text{Cs}(18\text{-crown-6})_2]^+e^-$  in 1983. This highly air- and

moisture-sensitive solid has a sandwich molecular structure, where the electron is trapped within nearly spherical lattice cavities. However, the shortest electron-electron distance is too long (8.68 Å) to make this material a conductor of electricity.

The cation that one wishes to encapsulate is either an alkali metal ion, such as sodium, potassium, or lithium-or it may be an alkaline earth metal ion, such as calcium or magnesium-or an ammonium ion. The size of the opening in the ring must be adjusted to match the size of the ion for maximum effect.<sup>1</sup> Thus, 12-crown-4 works best for lithium, whereas the larger opening sizes of 15-crown-5 and 18-crown-6 work best for sodium and potassium, respectively. The crown ethers used to encapsulate calcium and magnesium often add nitrogen atoms to the ring. Crown ethers are useful in phase-transfer catalysis. An interesting modified crown ether has been developed, with two ethereal rings, attached to each other by a nitrogen linkage. One of the rings can attach somewhat to a cation. Light then applied causes the nitrogen linkage to become modified, closing the other ethereal ring to attach to the other end of the cation. This has been likened to catching a ball (the ion) in a baseball glove (the ether structure). Various sized ions can be "caught" by such a structure.

The cavity diameter of the crown ethers and the diameter of the various cations are given in the following table.

Ions	Ionic diameter	Crown ether	Cavity diameter
Li <sup>+</sup>	1.36	All 12-Crown-4	1.2-1.5
Na <sup>+</sup>	1.94	All 15-Crown-5	1.7-2.2
K <sup>+</sup>	2.66	All 18-Crown-6	2.6-3.2
Rb <sup>+</sup>	2.94	All 21-Crown-7	3.4-4.3
Cs <sup>+</sup>	3.34	All 24-Crown-8	4.5-5.0
Ca <sup>2+</sup>	1.98	All 30-Crown-10	<6.0

---

## 8.9 Summary

---

In this unit following topics are discussed:

- General introduction of the alkali metals.
- Physical and chemical properties of alkali metals.
- General introduction of the alkali earth metals.
- Physical and chemical properties of alkali earth metals.
- Crown ethers, their synthesis and properties.

---

## 8.10 Glossary

---

1. Diamagnetism: Diamagnetic materials create a magnetic field in opposition to an externally applied magnetic field.
2. Ionisation energy: The ionization energy (IE) of an atom or molecule describes the minimum amount of energy required to remove an electron (to infinity) from the atom or molecule in the gaseous state.
3. Extraction: Extraction in chemistry is a separation process consisting in the separation of a substance from a matrix. It may refer to Liquid-liquid extraction, and Solid phase extraction.
4. Alloy: An alloy is a mixture or solid solution composed of a metal and another element.
5. Covalent bond: A covalent bond is a chemical bond that involves the sharing of electron pairs between atoms.
6. Oxidation number: The oxidation state, often called the oxidation number, is an indicator of the degree of oxidation of an atom in a chemical compound.
7. Electronegativity: Electronegativity is a chemical property that describes the tendency of an atom or a functional group to attract electrons (or electron density) towards itself.



---

## 8.11 Review Questions

---

1. write short notes on alkali and alkali earth metals.
2. Discuss the physical properties of alkali metals
3. Write detailed notes on physical and chemical properties of alkali earth metals.
4. What are crown ethers?
5. Write detailed notes on crown ethers.
6. Discuss crown ethers with suitable example.
7. What are crown ethers? Give their synthesis and properties.

---

## 8.11References and Suggested Readings

---

1. Concise Inorganic chemistry- J.D. Lee (Blackwell Science) 2001
2. Inorganic Chemistry- F.A. Cotton (Interscience publisher) 2008
3. Inorganic chemistry, principles of structure and reactivity- James E. Huheey (Harper Collins college publishers) 1993
4. Inorganic chemistry- G Sharpe, (Pearson printice hall) 2005
5. Inorganic chemistry- James E. House (Elsevier academic press) 2008
6. [en.wikipedia.org/](http://en.wikipedia.org/)

---

## Unit 9 Organometallic compounds

---

### Structure of Unit:

- 9.0 Objective
- 9.1 Introduction
- 9.2 Organometallic Compounds
- 9.3 Organomagnesium compounds
- 9.4 Organolithium reagent
- 9.5 Organosodium Compounds
- 9.7 Organoberyllium compounds
- 9.8 Organocalcium Compounds
- 9.9 Summary
- 9.10 Review Questions
- 9.11 References

---

### 9.0 Objective

---

Organometallic compounds show wide application in catalytic activity. That's why this chapter is being introduced in the book. This chapter deals with the synthesis, structure, application of some important organometallic compounds.

---

### 9.1 Introduction

---

Organometallic compounds are distinguished by the prefix "organo-" e.g. organopalladium compounds. Examples of such organometallic compounds include all Gilman reagents, which contain lithium and copper. Tetracarbonyl nickel, and ferrocene are examples of organometallic compounds containing transition metals. Other examples include organomagnesium compounds like iodo(methyl)magnesium  $\text{MeMgI}$ , diethylmagnesium ( $\text{Et}_2\text{Mg}$ ), and all Grignard reagents; organolithium compounds such as n-butyllithium ( $\text{n-BuLi}$ ), organozinc

compounds such as diethylzinc ( $\text{Et}_2\text{Zn}$ ) and chloro(ethoxycarbonylmethyl)zinc ( $\text{ClZnCH}_2\text{C}(=\text{O})\text{OEt}$ ); and organocopper compounds such as lithium dimethylcuprate ( $\text{Li}^+[\text{CuMe}_2]$ ).

The term "metalorganics" usually refers to metal-containing compounds lacking direct metal-carbon bonds but which contain organic ligands. Metal beta-diketonates, alkoxides, and dialkylamides are representative members of this class.

In addition to the traditional metals, lanthanides, actinides, and semimetals, elements such as boron, silicon, arsenic, and selenium are considered to form organometallic compounds, e.g. organoborane compounds such as triethylborane ( $\text{Et}_3\text{B}$ ).

Organometallics find practical uses in stoichiometric and catalytic processes, especially processes involving carbon monoxide and alkene-derived polymers. All the world's polyethylene and polypropylene are produced via organometallic catalysts, usually heterogeneously via Ziegler-Natta catalysis. Acetic acid is produced via metal carbonyl catalysts in the Monsanto process and Cativa process. Most synthetic aldehydes are produced via hydroformylation. The bulk of the synthetic alcohols, at least those larger than ethanol, are produced by hydrogenation of hydroformylation derived aldehydes. Similarly, the Wacker process is used in the oxidation of ethylene to acetaldehyde.

Organolithium, organomagnesium, and organoaluminium compounds are highly basic and highly reducing. They catalyze many polymerization reactions, but are also useful stoichiometrically.

III-V semiconductors are produced from trimethylgallium, trimethylindium, trimethylaluminium and related nitrogen / phosphorus / arsenic / antimony compounds. These volatile compounds are decomposed along with ammonia, arsine, phosphine and related hydrides on a heated substrate via metalorganic vapor phase epitaxy (MOVPE) process for applications such as light emitting diodes (LEDs) fabrication.

Organometallic compounds may be found in the environment and some, such as organolead and organomercury compounds are a toxic hazard.

---

## 9.2 Organo-metallic Compounds

---

Organometallic chemistry is the study of chemical compounds containing bonds between carbon and a metal. Organometallic compounds are those in which the carbon atoms of organic groups are bound to metal atom. Thus we do not include in his category compounds in which carbon containing components are bound to a metal through some other atoms such as oxygen, nitrogen or sulphur. Organometallic chemistry combines aspects of inorganic chemistry and organic chemistry. Organometallic compounds are widely used in homogeneous catalysis.

---

## 9.3 Organomagnesium compounds

---

The organic compounds of Ca, Sr and Ba are extremely ionic, reactive and of little utility or importance. Magnesium compounds of which the Grignard reagents are the best known, are most likely the widely used of all organometallic compounds. They are employed for the synthesis of alkyl and aryl compounds of other elements as well as for a host of organic synthesis. Beryllium makes a range of organometallic compounds, their hazardous nature has limited their study.

Grignard Reagents:

Grignard reagents (and the Grignard reaction using these compounds) are named after Victor Grignard. The Grignard reaction is an organometallic chemical reaction in which alkyl, vinyl, or aryl-magnesium halides add to a carbonyl group in an aldehyde or ketone. This reaction is an important tool for the formation of carbon-carbon bonds. The reaction of an organic halide with magnesium is not a Grignard reaction, but provides a Grignard reagent.

Preparation:

The general synthesis of a Grignard reagent involves the reaction of an alkyl halide (RX, where X = Cl, Br, I) with magnesium metal in a suitable ether solvent,.

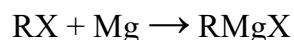

While diethyl ether (Et<sub>2</sub>O) and tetrahydrofuran (THF) are commonly used as solvents, other polar non-protic solvents are suitable, including: triethylamine

(NEt<sub>3</sub>), dimethylsulphide (Me<sub>2</sub>S), dimethylselenide (Me<sub>2</sub>Se), and dimethyltelluride (Me<sub>2</sub>Te).

Grignard reagents form via the reaction of an alkyl or aryl halide with magnesium metal. The reaction is conducted by adding the organic halide to a suspension of magnesium in an etherial solvent, which provides ligands required to stabilize the organomagnesium compound. Empirical evidence suggests that the reaction takes place on the surface of the metal. The reaction proceeds through single electron transfer. In the Grignard formation reaction, radicals may be converted into carbanions through a second electron transfer.

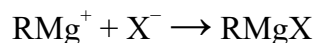
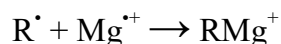
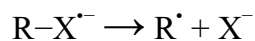
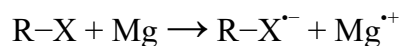

In general the alkyl halide is added to an excess of magnesium suspended in the solvent. In most cases it is necessary to activate the magnesium, by the addition of iodine (I<sub>2</sub>), 1,2-dibromoethane, or sonication. If the halide is very inert reaction can be promoted by the co-condensation of magnesium and THF under vacuum.

There is regularly an induction period after the initial addition of alkyl halide. However, since the reaction, equation 1, is highly exothermic care should be taken to ensure that the reaction does not run-away. For this reason it is normal to initially add a small quantity of the alkyl halide to ensure the reaction initiates. Once reaction is initiated, the addition of alkyl halide is maintained at a suitable rate to ensure the reaction is maintained until all the alkyl halide is consumed. The purity of the magnesium is very main. It is now more typical to use 99.8% pure magnesium.

In fact alkyl fluorides are sufficiently inert that highly coordinating polar solvents such as THF or dimethylformamide (DMF) must be used.

If the reaction is allowed to get too hot then several possible side reactions can occur. In THF reaction with the solvent occurs:

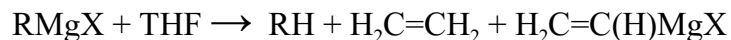

The mechanism for Grignard formation is thought to be radical in nature; Though, a study of the surface of the magnesium during the reaction has shown the presence of corrosion pits. It is generally approved that initiation occurs at surface dislocations, but the major reaction occurs at a polished surface.

The reaction of magnesium with aryl bromides has been studied and is proposed to occur by two reactions. The first step electron transfer between the aryl halide and the metal, while the second involves aryl radical formation.

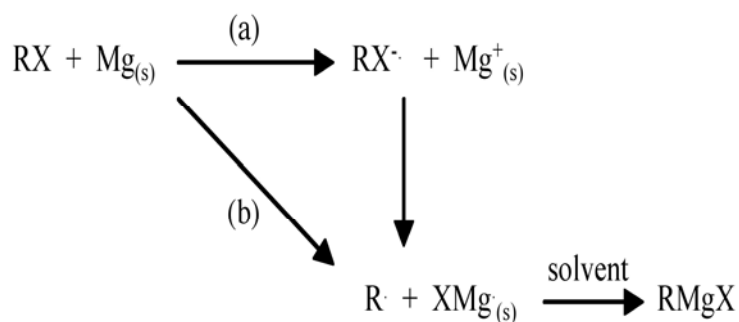

### Structure:

The solid state structure of Grignard reagents is controlled by the presence and identity of the solvent used in the synthesis. In this regard the size and the basicity of the solvent is important. For example, the structure of EtMgBr crystallized from diethyl ether exists as a 4-coordinate monomer (Figure 1a), while the use of the sterically less demanding THF results in a 5-coordinate monomeric structure (Figure 1b). In contrast, the use of triethylamine yields a dimeric bromide bridged structure (Figure 1c), and the use of a chelate bidentate amine gives a structure (Figure 1d) similar to that observed with diethyl ether (Figure 1a).

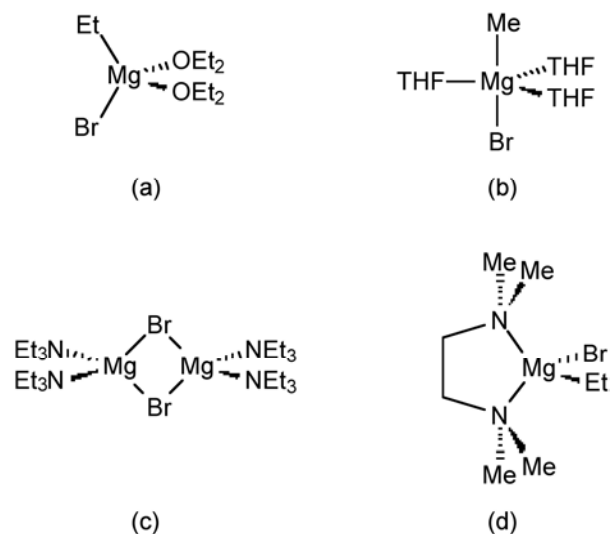

**Figure 1:** Molecular structure of EtMgBr in (a) diethyl ether, (b) THF, (c) triethyl amine, and (d) tetramethylethylenediamine (TMED).

### Dialkyl magnesium ( $R_2Mg$ )

Dialkyl magnesium compounds are nonvolatile white solids. They generally have similar reactivity to their Grignard analogs.

### Synthesis

The general synthesis of  $R_2Mg$  is carried out by the reaction of a Grignard with dioxane ( $C_4H_8O_2$ ), where the precipitation of the dihalide is the reaction driving force.

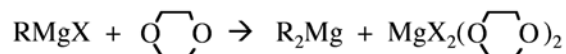

There is another synthesis that does not require dioxane involves the metal exchange reaction between magnesium metal and a dialkyl mercury compound.



Finally, in selected cases, magnesium will react with acidic hydrocarbons such as cyclopentadienyl at high temperatures (600 °C).

### Structure

The vapor phase dialkyl magnesium compounds are generally monomeric linear compounds. In solution, the absence of coordinating solvents  $R_2Mg$  form a variety of oligomers (Figure 2a-c) in solution as determined by molecular weight measurements. In the presence of coordinating solvents 4-coordinate monomers predominate (Figure 2d).

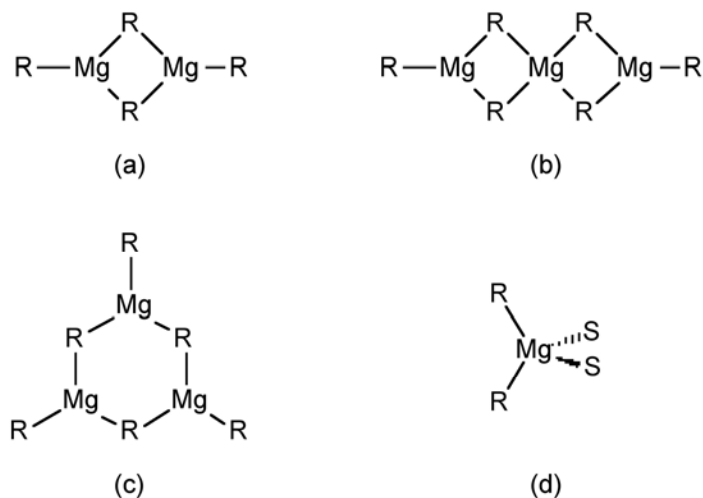

**Figure 2:** Solution structure of  $R_2Mg$  ( $R = Me, Et$ ) in (a – c) non-coordinating solvents, and (d) diethyl ether.

As similar trend is observed in the solid state, where polymers have been characterized in the absence of coordinating solvents (Figure 3a), while monomers or dimers are generally observed when crystallized from a coordinating solvent (Figure 3b and c).

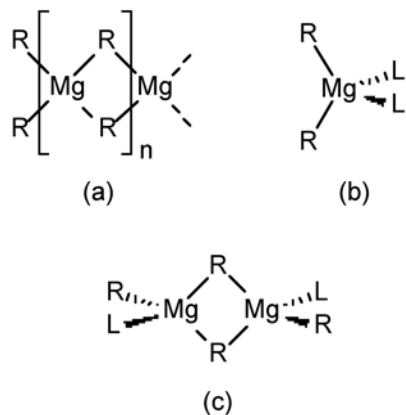



**Figure 3:** Solid state structure of  $R_2Mg$  ( $R = Me, Et$ ) crystallized in (a) the absence and (b and c) the presence of a coordinating solvents.

The use of organomagnesium compounds in organic synthesis

### Hydrolysis and related reactions

Grignard compounds react with water to provide the hydrocarbon, they also react with other hydroxylic compounds such as alcohols and carboxylic acids. One important use of the hydrolysis reaction is specifically deuteration,

The hydrogen atom on a terminal alkyne is adequately acidic that the reaction with Grignards occurs in an analogous manner to that of hydrolysis.

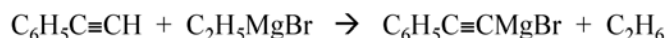

Reaction with  $CO_2$

Grignards react readily with carbon dioxide to form the carboxylate, which yields the associated carboxylic acid upon hydrolysis,

Reaction with carbonyls

Organomagnesium compounds react with organic carbonyls (aldehydes, ketones, and esters) to yield the alcohol on hydrolysis, This synthetic route is found to be useful for the formation of primary, secondary and terminal alcohols. Reaction with acyl halides

Acyl halides react with Grignards to give ketones, Equation 21. Best results are obtained if the reaction is carried out at low temperature and in the presence of a Lewis acid catalysts (e.g.,  $FeCl_3$ ).

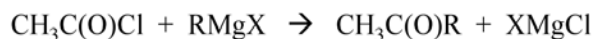

Reaction with epoxides

Oxirane (epoxide) rings are opened by Grignards, in a useful reaction that extends the carbon chain of the Grignard by two carbon atoms. This reaction is best performed with ethylene oxide since the magnesium halide formed is a Lewis acid catalyst for further reactions in the case of substituted oxiranes.

## Reaction with salts

One of the most useful methods of preparing organometallic compounds is the exchange reaction of one organometallic compound with a salt of a different metal. This is an equilibrium process, whose equilibrium constant is defined by the reduction potential of both metals. In general the reaction will proceed so that the more electropositive metal will form the more ionic salt (usually chloride).



Grignard reagents are particularly useful in this regard, and may be used to prepare a wide range of organometallic compounds.

---

## 9.4 Organolithium reagent

---

Organolithium reagents are organometallic compounds that contain carbon – lithium bonds. They are important reagents in organic synthesis, and are frequently used to transfer the organic group or the lithium atom to the substrates in synthetic steps, through nucleophilic addition or simple deprotonation

Organolithium reagents are used in industry as an initiator for anionic polymerization, which leads to the production of various elastomers. They have also been applied in asymmetric synthesis in the pharmaceutical industry.

Due to the large difference in electronegativity between the carbon atom and the lithium atom, the C-Li bond is highly ionic. This extremely polar nature of the C-Li bond makes organolithium reagents good nucleophiles and strong bases. These reagents are highly reactive, sometimes pyrophoric, and should be handled with extreme caution.

chemists found that in comparison with Grignard reagents, organolithium reagents can often perform the same reactions with increased rates and higher yields, such as in the case of metalation.

Since then, organolithium reagents have surpassed Grignard reagents in usage.

## Structure:

Although simple alkyllithium species are often represented as monomer RLi, they exist as aggregates (oligomers) or polymers. Their structures depend on the nature of organic substituent and the presence of other ligands.

### Nature of carbon-lithium bond

A simplistic look at the large difference in electronegativity suggests the C-Li bond to be highly ionic.<sup>1</sup> Certain organolithium compounds possess properties such as solubility in nonpolar solvents that complicate the issue.

In allyl lithium compounds, the lithium cation coordinates to the face of the carbon  $\pi$  bond in an  $\eta$ -<sub>3</sub> fashion instead of a localized, carbanionic center, thus, allyllithiums are often less aggregated than alkyllithiums.

In aryllithium complexes, the lithium cation coordinates to a single carbanion center through a Li-C  $\sigma$  type bond.

### Solid state structure

Like other species consisting of polar subunits, organolithium species aggregate.

A basic building block toward constructing more complex structures is a carbanionic center interacting with a Li<sub>3</sub> triangle in an  $\eta$ -<sub>3</sub> fashion.

In simple alkyllithium reagents, these triangles aggregate to form tetrahedron or octahedron structures. For example, methyl lithium, ethyllithium and *tert*-butyllithium all exist in the tetramer [RLi]<sub>4</sub>.

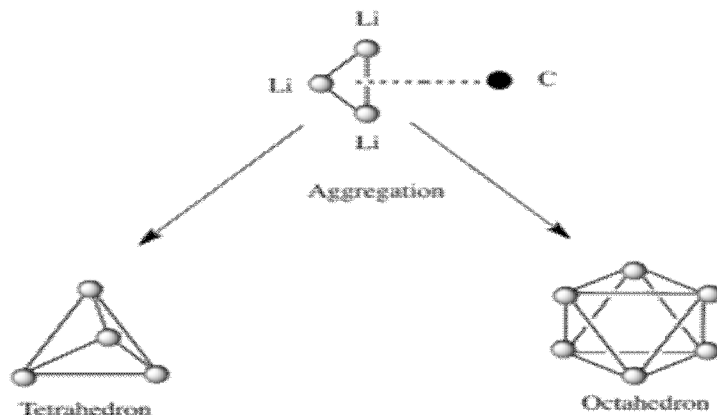

**Figure 4:** Tetrahedron and octahedron metal cores formed by aggregation of the  $\text{Li}_3$  triangle carbanion coordinate complex.

Another class of alkyllithium adopts hexameric structures, such as *n*-butyllithium, isopropyllithium, and cyclohexanyllithium. Common lithium amides, e.g. lithium bis(trimethylsilyl)amide, and lithium diisopropylamide are also subject to aggregation. Lithium amides adopt polymeric-ladder type structures in non-coordinating solvent in the solid state, and they generally exist as dimers in ethereal solvents.

Another important class of reagents is silyllithiums, extensively used in the synthesis of organometallic complexes and polysilanedendrimers.

In the solid state, most silyllithiums tend to form monomeric structures coordinated with solvent molecules such as THF, and only a few silyllithiums have been characterized as higher aggregates.

#### Reactivity and Applications

The C-Li bond in organolithium reagents is highly polarized. As a result, the carbon assumes most of the electron density in the bond and resembles a carbanion. Thus, organolithium reagents are strongly basic and nucleophilic.

#### **Organolithium reagent as nucleophile**

##### **Carbolithiation reactions**

As nucleophiles, organolithium reagents undergo carbolithiation reactions, whereby the carbon-lithium bond adds across a carbon-carbon double or triple bond, forming new organolithium species. This reaction is the most widely employed reaction of organolithium compounds.

##### **Addition to carbonyl compounds**

Nucleophilic organolithium reagents can add to electrophilic carbonyl double bonds to form carbon-carbon bonds. They can react with aldehydes and ketones to produce alcohols.

Organolithium reagents are also superior to Grignard reagents in their ability to react with carboxylic acids to form ketones.

A more common way to synthesize ketones is through the addition of organolithium reagents to Weinreb amides (N-methoxy-N-methyl amides). This reaction provides ketones when the organolithium reagents is used in excess

Organolithium reagents can also react with carbon dioxide to form carboxylic acids.

### **S<sub>N</sub>2 type reactions**

Organolithium reagents can serve as nucleophiles and carry out S<sub>N</sub>2 type reactions with alkyl or allylic halides

Although they are considered more reactive than Grignards reactions in alkylation, their use is still limited due to competing side reactions such as radical reactions or metal-halogen exchange.

Organolithium reagents can also carry out nucleophilic attacks with epoxides to form alcohols.

Organolithium reagent as base

Organolithium reagents provide a wide range of basicity. tert-Butyllithium, with three weakly electron donating alkyl groups, is the strongest base commercially available (pK<sub>a</sub> = 53).

Some commonly used lithium bases are alkyllithium species such as *n*-butyllithium and lithium dialkylamides (LiNR<sub>2</sub>).

Metalation

Metalation with organolithium reagents, also known as lithiation or lithium-hydrogen exchange, is achieved when a basic organolithium species, most commonly an alkyllithium, abstracts a proton and forms a new organolithium species.

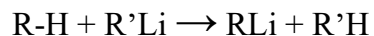

Common metalation reagents are often butyllithiums. *tert*-Butyllithium and *sec*-butyllithium are generally more reactive and have better selectivity than *n*-butyllithium. Metalation is a common way of preparing versatile organolithium reagents.

## Superbase

Addition of potassium alkoxide to alkyllithium greatly increases the basicity of organolithium species. The most common “superbase” can be formed by addition of KOtBu to butyllithium, often abbreviated as “LiCKOR” reagents. These “superbases” are highly reactive and often stereoselective reagents.

## Lithium enolates

Lithium enolates are formed through deprotonation of a proton  $\alpha$  to the carbonyl group by an organolithium species. Lithium enolates are widely used as nucleophiles in carbon-carbon bond formation reactions such as aldol condensation and alkylation. They are also an important intermediate in the formation of silyl enol ether.

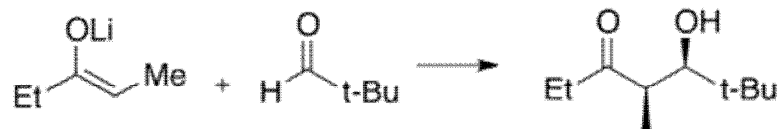

## Lithium-Halogen exchange

Lithium halogen exchange is a metathesis reaction between an organohalide and organolithium species.



The rate of lithium halogen exchange is extremely fast. It is usually faster than nucleophilic addition and can sometimes exceed the rate of proton transfer.

Lithium-halogen exchange is very useful in preparing new organolithium reagents. The trend of exchange rates usually follows  $I > Br > Cl$ , while alkyl- and arylfluoride are generally not reactive toward organolithium reagents. Lithium halogen exchange is kinetically controlled.

## Transmetalation

Organolithium reagents are often used to prepare other organometallic compounds via transmetalation. Organocopper, organotin, organosilicon, organoboron,

organophosphorus, organocerium and organosulfur compounds are frequently prepared by reacting organolithium reagents with appropriate electrophiles.



Organolithium can also be used in to prepare organozinc compounds through transmetalation with zinc salts.

Preparation

Most simple alkyllithium reagents, and common lithium amides are commercially available in a variety of solvents and concentrations.

Reaction with lithium metal

Reduction of alkyl halide with metallic lithium can afford simple alkyl and aryl organolithium reagents.



Industrial preparation of organolithium reagents is achieved using this method by treating the alkyl chloride with metal lithium containing 0.5-2% sodium.

---

## 9.5 Organosodium Compounds

---

Organosodium chemistry is the chemistry of organometallic compounds containing a carbon to sodium chemical bond. The application of organosodium compounds in chemistry is limited in part due to competition from organolithium compounds, which are commercially available and exhibit more convenient reactivity.

The principal organosodium compound of commercial importance is sodium cyclopentadienide. Sodium tetraphenylborate is also an organosodium compound

Organometal bonds in group 1 are characterised by high polarity with corresponding high nucleophilicity on carbon. The carbanionic nature of organosodium compounds can be minimized by resonance stabilization. One consequence of the highly polarized Na-C bond is that simple organosodium compounds tend to aggregate and are often poorly soluble.

### Synthesis and structure:

The usual method for preparing organosodium compounds involves deprotonation. Sodium cyclopentadienide is thus prepared by treating sodium metal and cyclopentadiene:

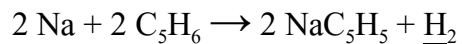

Trityl sodium can be prepared by metal-halogen exchange. This method is used in preparing trityl sodium:

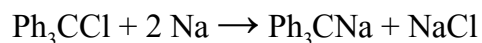

Sodium also reacts with polycyclic aromatic hydrocarbons via one-electron reduction. With solutions of naphthalene, it forms the deeply coloured radical sodium naphthalenide, which is used as a soluble reducing agent:

In the original work the alkylsodium compound was accessed from the dialkylmercury compound by transmetallation.

Simple organosodium compounds such as the alkyl and aryl derivatives are generally insoluble polymers.

### Reactions:

Organosodium compounds are traditionally used as strong bases

The higher alkali metals are known to metalate even some unactivated hydrocarbons and are known to self-metalate

In the **Wanklyn reaction** organosodium compounds react with carbon dioxide to give carboxylates:

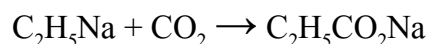

Grignard reagents undergo a similar reaction.

Some organosodium compounds degrade by beta-elimination

Industrial applications

Although organosodium chemistry has been described to be of "little industrial importance", it once was central to the production of tetraethyllead.



A similar Wurtz coupling-like reaction is the basis of the industrial route to triphenylphosphine:



The higher alkali metals, organopotassium, organorubidium and organocaesium, are even more reactive than organosodium compounds and of limited utility.

The higher alkali metals also favor the sterically congested conformation.

---

## 9.7 Organoberyllium compounds

---

Organoberyllium chemistry is limited to academic research due to the cost and toxicity of beryllium, beryllium derivatives and reagents required for the introduction of beryllium, such as beryllium chloride. Examples of known organoberyllium compounds are dineopentylberyllium, beryllocene ( $\text{Cp}_2\text{Be}$ ), diallylberyllium (by exchange reaction of diethyl beryllium with triallyl boron) and bis(1,3-trimethylsilylallyl)beryllium. Ligands can also be aryls and alkynyls.

---

## 9.8 Organocalcium Compounds

---

organocalcium chemistry should be quite extensive; however, advances in this chemistry have been hindered by the lack of an easy preparation for organocalcium products. Reacting the calcium metal with organic substrates results in reduced activity due to surface poisoning factors, which restrict the oxidative addition.

A well known organocalcium compound is (Cp)calcium(I). Bis(allyl)calcium was described in 2009.[14] It forms in a metathesis reaction of allylpotassium and calcium iodide as a stable non-pyrophoric off-white powder:



The bonding mode is  $\eta^3$ . This compound is also reported to give access to an  $\eta^1$  polymeric  $(\text{CaCH}_2\text{CHCH}_2)_n$  compound.[15]

The compound  $[(\text{thf})_3\text{Ca}\{\mu\text{-C}_6\text{H}_3\text{-1,3,5-Ph}_3\}\text{Ca}(\text{thf})_3]$  also described in 2009[16][17] is an inverse sandwich compound with two calcium atoms at either side of an arene.

Olefins tethered to cyclopentadienyl ligands have been shown to coordinate to calcium(II), strontium(II), and barium(II):

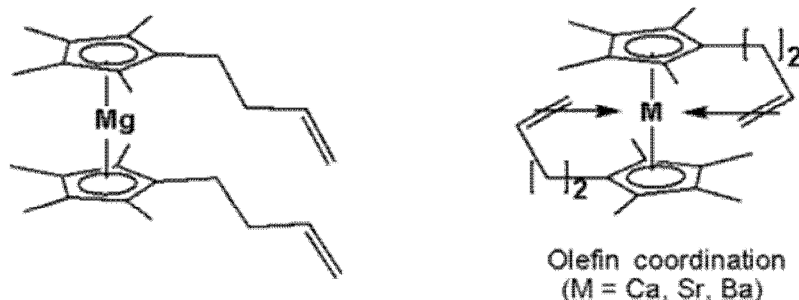

Olefin complexes of calcium, strontium and barium

---

## 9.9 Summary

---

The unit summarized as :-The term "metalorganics" usually refers to metal-containing compounds lacking direct metal-carbon bonds but which contain organic ligands. Metal beta-diketonates, alkoxides, and dialkylamides are representative members of this class. In addition to the traditional metals, lanthanides, actinides, and semimetals, elements such as boron, silicon, arsenic, and selenium are considered to form organometallic compounds, e.g. organoborane compounds such as triethylborane ( $\text{Et}_3\text{B}$ ). Organometallics find practical uses in stoichiometric and catalytic processes, especially processes involving carbon monoxide and alkene-derived polymers. All the world's polyethylene and polypropylene are produced via organometallic catalysts, usually heterogeneously via Ziegler-Natta catalysis. Acetic acid is produced via metal carbonyl catalysts in the Monsanto process and Cativa process. Most synthetic aldehydes are produced via hydroformylation. The bulk of the synthetic alcohols, at least those larger than ethanol, are produced by hydrogenation of hydroformylation derived aldehydes.

Similarly, the Wacker process is used in the oxidation of ethylene to acetaldehyde. Organolithium, organomagnesium, and organoaluminium compounds are highly basic and highly reducing. They catalyze many polymerization reactions, but are also useful stoichiometrically. III-V semiconductors are produced from trimethylgallium, trimethylindium, trimethylaluminium and related nitrogen / phosphorus / arsenic / antimony compounds. These volatile compounds are decomposed along with ammonia, arsine, phosphine and related hydrides on a heated substrate via metalorganic vapor phase epitaxy (MOVPE) process for applications such as light emitting diodes (LEDs) fabrication. Organometallic compounds may be found in the environment and some, such as organolead and organomercury compounds are a toxic hazard.

---

### 9.10 Review Questions

---

1. What are organometallic compounds?
2. Give method of preparation of organosodium compounds.
3. What is Grignard Reagent, discuss its structure.
4. Discuss Organolithium compounds.
5. Define organoberillium and organocalcium compounds.

---

### 9.11 Refernces

---

1. Concise Inorganic chemistry- J.D. Lee (Blackwell Science) 2001
2. Inorganic Chemistry- F.A. Cotton (Interscience publisher) 2008
3. Inorganic chemistry, principles of structure and reactivity- James E. Huheey (Harper Collins college publishers) 1993
4. Inorganic chemistry- G Sharpe, (Pearson printice hall) 2005
5. Inorganic chemistry- James E. House (Elsevier academic press) 2008
6. [en.wikipedia.org/](http://en.wikipedia.org/)

---

# Unit - 10 :Boron Group

---

## Structure of Unit

---

- 10.0 Objectives
- 10.1 Introduction
- 10.2 Boron Hydrides
- 10.3 Preparations:
- 10.4 Interconversion of boranes:
- 10.5 Structure and Bonding of Boranes
- 10.6 Metalloborane
- 10.7 Carborane
- 10.9 Summary
- 10.10 Review Questions
- 10.11 References and Suggested Readings

## 10.0 Objectives

---

This chapter deals with the boron group of the periodic table. One can know the properties of boron hydride, its structure, bonding in diborane, various metalloborane, carboranes by reading this chapter.

## 10.1 Introduction

---

A boranes comprise a large group of compounds with the generic formula of  $B_xH_y$ . These compounds do not occur in nature. Many of the boranes readily oxidise on contact with air, some violently. The class is named after the parent chemical called "borane" itself, chemical formula  $BH_3$ . This compound is only known to exist as a transient intermediate since it dimerises to form diborane,  $B_2H_6$ . The larger boranes all consist of boron clusters that are polyhedral. In addition to the charge-neutral boranes, a large number of anionic boron hydrides are known. The most

important boranes are diborane  $B_2H_6$  and two of its pyrolysis products, pentaborane  $B_5H_9$  and decaborane  $B_{10}H_{14}$ .

Borane-clusters, in which metals are present are known as 'Metalloboranes'. Many metalloboranes have been prepared. In some cases metal atom is attached with the borohydride ion through hydrogen bridge. The most common and important metalloborane group is one in which direct metal boron bond is present.

A carborane is a cluster composed of boron, carbon and hydrogen atoms. Like many of the related boranes, these clusters are polyhedra and are similarly classified as closo-, nido-, arachno-, hypho-, etc. based on whether they represent a complete (closo-) polyhedron, or a polyhedron that is missing one (nido-), two (arachno-), or more vertices. Interesting examples of carboranes are the extremely stable icosahedral closo-carboranes. These boron-rich clusters exhibit unique organomimetic properties with chemical reactivity matching classical organic molecules, yet structurally similar to metal-based inorganic and organometallic species.

---

## 10.2 Boron Hydrides

---

Several hydrides of boron have been recognized so far, they are commonly known as boranes (analogy with the alkanes, hydrocarbons). These hydrides can be represented by two general formulae  $B_nH_{n+4}$  and  $B_nH_{n+6}$ . The former are more stable than the latter. According to IUPAC system of nomenclature, the number of boron atoms in the borane molecule is indicated by a Greek numerical prefix e.g. di, tri, tetra, penta, hexa etc. followed by the number which indicates the number of hydrogen atoms. For example,  $B_6H_{10}$  is called hexaborane-Iu, Here hexa indicates the number of boron atoms and 10 indicates the number of hydrogen atoms. But for polyboranes of closed structure prefix closo is used and of non-closed structure prefix nido is used.

### **Classification:**

On the basis of structures, molecular formula and skeletal electrons higher boranes are classified into Closo, Nido, Arachno and Hypo boranes.

1. Closo Boranes: These are closed structured (Closo, Greek, meaning cage) boranes with the molecular formula  $[B_nH_n]^{2-}$  and skeletal electrons =  $n+1$  pairs (=  $2n+2$  electrons). In this structure, there is one boron atom placed at each apex and there are no B-H-B bonds present in the molecule. All the member of the series from  $n=5$  to 12 are known.  $[B_5H_5]^{2-}$  is trigonal bipyramidal,  $[B_6H_6]^{2-}$  is octahedral and  $[B_{12}H_{12}]^{2-}$  is icosahedral. All are stable on heating and are quite inert.
2. Nido-Boranes: These boranes have nest (Nido, Latin, meaning Nest) like structure. Their general formula is  $B_nH_n+4$  and have  $(n+2)$  pairs =  $2n+4$  skeletal electrons on removing one boron atom from an apex of closo structure, nido structure is obtained. Because, of the lost boron atom, these boranes have extra hydrogens for completing the valency. The polyhedra in this series have B-H-B bridge bonds in addition to B-B bonds. They are comparatively less stable than 'Closo', but more than 'Arachno' on heating.
3. Arachno-Boranes: These boranes have the general formula  $(B_nH_n+6)$  and skeletal electrons =  $(n+3)$  pairs =  $2n+6$  = electrons. These molecules are obtained by removing two boron atoms from two apexes of the closo structure and have spider-web like structure. They have B-H-B bridge-bonds in their structures and are very reactive and unstable on heating.

---

### 10.3 Preparations:

---

(i) Stock and his coworkers prepared a mixture of boron hydride ( $B_2H_6$ ,  $B_4H_{10}$ ,  $B_5H_9$  etc.) by the reaction of magnesium boride and moderately concentrated hydrochloric acid.



The different boranes are separated by distillation method.

(ii) Diborane may also be prepared by the following reactions :

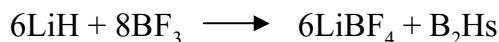
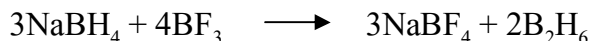

Electric discharge

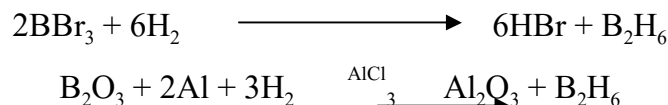

(iii) When diborane is decomposed in a silent electric discharge in the presence of an inert gas, it gives mixture of  $\text{B}_4\text{H}_{10}$  (40%),  $\text{B}_5\text{H}_9$  (20%),  $\text{B}_5\text{H}_{11}$  (30%),  $\text{B}_9\text{H}_{15}$  and other in small quantity.

(iv) Pentaborane-9 may be prepared by circulating a mixture of diborane and hydrogen through a glass tube at  $200^\circ\text{-}250^\circ\text{C}$ .



While pentaborane-11 may be prepared by heating a mixture of diborane and tetraborane-10.



## 10.4 Interconversion of boranes:

Different boranes may also be obtained by heating different boranes at specific temperature.

For example (a)  $\text{B}_2\text{H}_6$  on heating at different temperatures gives higher boranes as shown below :

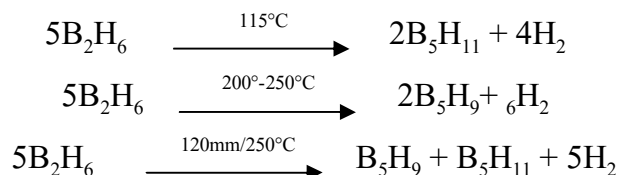

(b)  $\text{B}_4\text{H}_{10}$  may be converted into higher boranes as shown below:

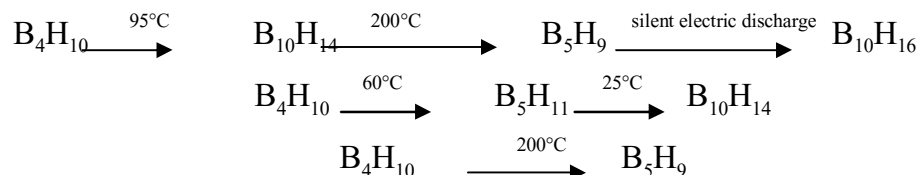

(c)  $\text{B}_5\text{H}_{11}$  on heating with  $\text{H}_2$  at  $100^\circ\text{C}$  gives a mixture of  $\text{B}_4\text{H}_{10}$  and  $\text{B}_2\text{H}_6$ .

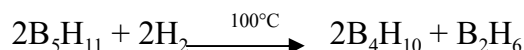

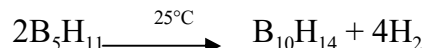

Non-volatile Boranes: Only the above mentioned hydrides of boron and some others are volatile. But several non-volatile solid hydrides have been prepared by the action of heat on the volatile hydrides. Spontaneous decomposition of hexaboranes at room temperature yields a yellow crystalline hydride of the formula  $\text{B}_{26}\text{H}_{36}$ .

Properties : (i) The boranes are volatile compounds.

(ii) All the hydrides of boron are decomposed to boron and hydrogen on red heat.

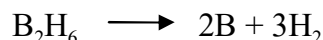

(iii) All the boranes are readily oxidised by air or oxygen and form explosive mixture.

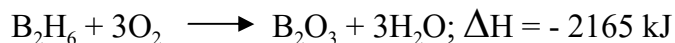

(iv) The boranes are decomposed by alkalis.

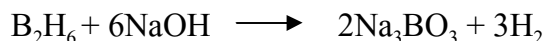

But at  $0^\circ\text{C}$  it reacts with concentrated solution of KOH to give potassium hypoborate and metaborate.

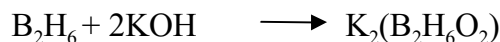

Some other examples are :

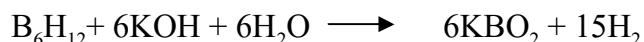

(v) Boranes are easily decomposed by water liberating  $\text{H}_2$ . The rate of reaction varies widely. For example,

$\text{B}_2\text{H}_6$  is decomposed very rapidly.

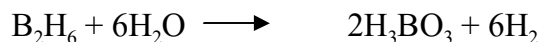



(vi) They react with halogens under controlled conditions, to form a mixture to partially halogenated products.

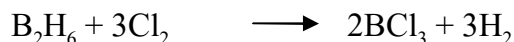
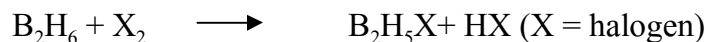

(vii) These hydrides form adducts with Lewis bases.



(viii) By the reaction of alkyls, alkyl derivatives are formed.

(ix) All boranes react with halogen acids to form mono-haloborane.

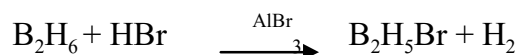
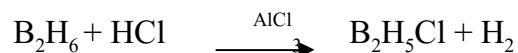

(x) Diborane reacts with methyl alcohol to form dimethoxyborane which disproportionates easily into diborane and trimethyl borate.

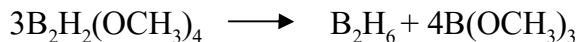
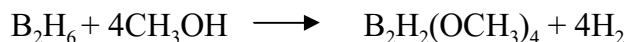

(xi) Decaborane reacts with Lewis bases such as  $\text{CH}_3\text{CN}$ ,  $\text{C}_5\text{H}_5\text{N}$ ,  $(\text{CH}_3)_2\text{S}$  etc. to give hydrogen.



(xii) When  $\text{B}_2\text{H}_6$  is treated with sodium or potassium amalgam corresponding adducts are formed.

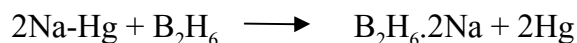

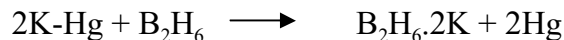

(xiii)  $\text{B}_2\text{H}_6$  adds to alkenes and alkynes in ether at room temperature to give organo-boranes which is called hydro boration reaction.

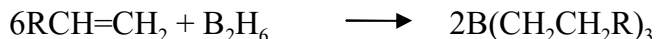

(xiv)  $\text{B}_2\text{H}_6$  reacts with ionic hydride ( $\text{LiH}$ ,  $\text{NaH}$ ,  $\text{BeH}_2$ ,  $\text{MgH}_2$ ) in ether to form metallic borohydride .



$\text{B}_2\text{H}_6$  reacts with organometallic compounds  $\text{MR}_x$  in ether to form metallic borohydride.

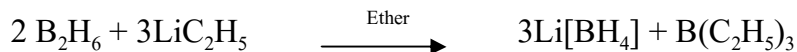

$\text{B}_2\text{H}_6$  reacts with  $\text{LiAlH}_4$  to form borohydrides of Li and Al.

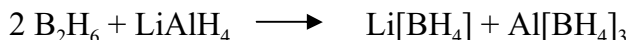

### Uses:

Diborane is the only among the boranes which is frequently used. Diborane is used:

- (i) As a catalyst in polymerisation reactions.
- (ii) As a reducing agent in organic reactions.
- (iii) For welding torches.
- (iv) For preparing substances which are used as high energy fuels and propellents. This is due to liberation of a large amount of heat during oxidation.

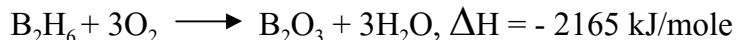

### Differences between Diborane and Ethane

1. Diborane is a dimer of  $\text{BH}_3$ , while ethane is not a dimer of  $\text{CH}_3$

2.  $\text{BH}_3$  is an electron deficient compound, while  $\text{CH}_3$  is a free radical or methyl radical  
 $(-\text{CH}_3)\cdot$
3.  $\text{C}_2\text{H}_6$  is a second member of alkanes which is a saturated hydrocarbon, while  $\text{B}_2\text{H}_6$  is a first member of boranes.
4.  $\text{B}_2\text{H}_6$  gives different types of chemical reactions e.g. reactions with acids, alkalis, alcohols, Lewis bases, alkali-amalgams, ethers, carbon monoxide, oxidation etc. while  $\text{C}_2\text{H}_6$  gives mainly 'substitution reactions being an alkane.
5.  $\text{B}_2\text{H}_6$  consists of bridging H-atom, while  $\text{C}_2\text{H}_6$  does not contain such H-atom.
6.  $\text{B}_2\text{H}_6$  liberates too much heat on combustion, while  $\text{C}_2\text{H}_6$  does not.

---

### Wade's Rule

---

In 1970 K. Wade gave a rule relating the number of electrons in the higher borane molecules with their formulae and shapes. Using these rules one can predict the general shapes of the molecules from their formulae. These rules are also applicable on carboranes and other polyhedral molecules called 'Deltahedral's Deltahedrons are so called, as they are composed of delta,  $\Delta$ , shaped triangular faces.

According to Wade's rule, the building blocks of deltahedrons are BH units, which are formed by  $sp$ -hybridisation of boron atom. Out of the two  $sp$  hybrids one is used in the formation of  $2c, 2e$  B-H exo bond of the deltahedron and the other  $sp$  hybrid is directed inside as a radial orbital. Remaining two unhybridised  $p$  orbitals of each boron atoms are placed perpendicular to the radial orbitals and are known as tangential orbitals. These radial and tangential orbitals combine by linear combination method to form skeleton or framework of the deltahedron. To fill all bonding molecular orbitals of the skeleton, necessary number of electrons are obtained from the radial orbitals of BH units and  $s$  orbitals of the extra hydrogen atoms. These electrons are called **Skeletal electrons**. For example in  $\text{B}_4\text{H}_{10}$ , four

BH units contribute 8 electrons ( $4 \times 2 = 8$ ) and six extra hydrogens give six electrons thus  $B_4H_{10}$  has total 14 skeletal electrons Figure given bellow gives the molecular energy diagram of  $[B_6H_6]^{2-}$ . This molecule has seven pairs of skeletal electrons (six boron atoms and one pair from two negative charges). These are used to saturate seven skeletal molecular orbitals ( $a_{1g}$ ,  $t_{1u}$  and  $t_{2g}$ ).

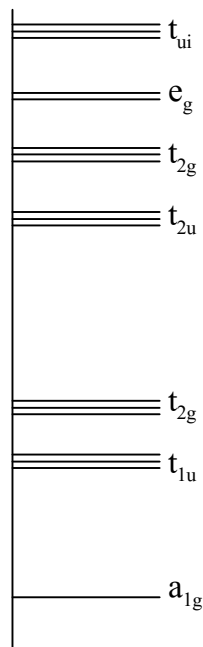

Figure: Skeletal molecular energy diagram of  $[B_6H_6]^{2-}$

---

## 10.5 Structure and Bonding of Boranes

---

### Structure of Diborane

The structure of the diborane is of great interest. The diborane is an electron deficient compound i.e. there are not enough valency electrons to form the expected number of covalent bonds. The following structures were proposed for diborane:

The ethane like structure of diborane and the ionic form :

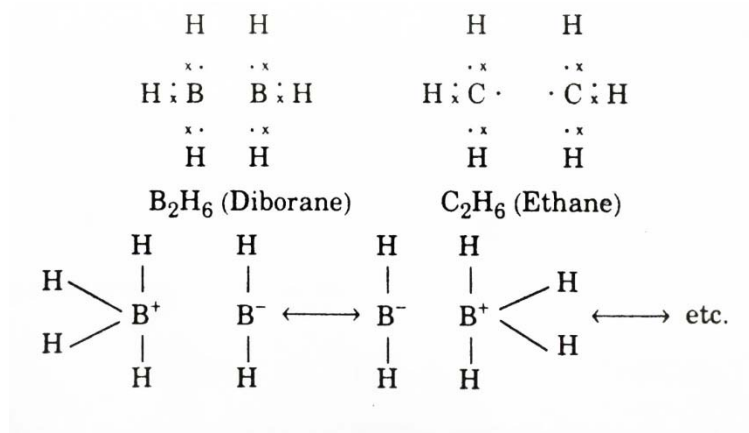

These structures have lack of experimental support, hence treated as incorrect one.  $\text{B}_2\text{H}_4^{2-}$  anion is isoelectronic with ethylene  $\text{C}_2\text{H}_4$  but these two are not isostructural. Because this ion has a cloud of electron density above and below the B-H plane as in  $\text{C}_2\text{H}_4$ . The neutral  $\text{B}_2\text{H}_6$  molecule could then be formally produced by embedding a proton in the electronic cloud above and below the plane of  $\text{B}_2\text{H}_4^{2-}$  ion. Although this structure was not accepted but this bonding model is currently accepted as the three centre-two electron 3c-2e bond. Recent work on electron diffraction and spectral studies support the hydrogen bridge structure in which one hydrogen atom form a bridge between two boron atoms, while the terminal hydrogen atoms form normal covalent bonds with boron atoms. This structure may be represented as below:

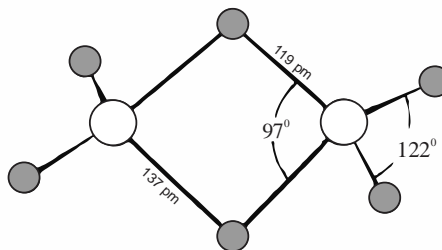

Figure : Hydrogen bridged structure of diborane molecule.

In this structure four hydrogen atoms (two each on the left and right hand side) are known as terminal hydrogens ( $\text{H}_t$ ) and two other hydrogen atoms are known as bridging hydrogens ( $\text{H}_b$ ). The two boron atoms and four terminal hydrogen

atoms lie in the same plane while two bridging hydrogen atoms lie in a plane perpendicular to this plane. Different parameters are as given below :

The bond lengths between B-H<sub>t</sub>, B-H<sub>b</sub> and B-B are 1.19 Å, 1.37 Å and 1.77 Å respectively, B-H<sub>b</sub> is longer than B-H<sub>t</sub> due to electron deficiency. Bond angles  $\angle H_t B H_t$ ,  $\angle B H_b B$  and  $\angle H_b B H_b$  are 122°, 100° and 97° respectively.

The above bridge structure is supported by the following facts :

- (i) Electron diffraction measurements confirm that four terminal hydrogen atoms are coplanar and two bridge hydrogen atoms occupy the place above and below the plane.
- (ii) Vibrational spectral (Raman and infrared) studies show two intense bands at 2102 cm<sup>-1</sup> and 2523 cm<sup>-1</sup> for B-H bonds. This indicates that all the B-H bonds are not identical.
- (iii) Nuclear magnetic resonance studies show three main regions of absorption which are due to boron atoms, terminal hydrogen atoms and bridge hydrogen atoms. These studies again support the presence of bridging structure.
- (iv) The specific heat of diborane is found to be 54.4 kJ while for ethane it is 12.5 kJ. This indicates that there is hindrance of rotation in diborane molecule that is due to bridge structure. Because bridge structure is considered it should be 21-63 kJ.
- (v) Diborane on methylation gives B<sub>2</sub>H<sub>2</sub>(CH<sub>3</sub>)<sub>4</sub> indicating that four hydrogen atoms are of different nature than the rest two hydrogen atoms i.e. bridge hydrogen atoms.

### **Nature of Bonding in Hydrogen-Bridge: Structure of Diborane**

The hydrogen bridge formation is now well established. The orbital theory explains its formation, in which boron atoms show  $sp^3$  hybridisation.

Because three electrons are available hence out of four  $sp^3$  hybrid orbitals, one  $sp^3$  hybrid orbital is empty. There is one s-orbital of hydrogen atom. Now two  $sp^3$  hybrid orbitals of one boron atom overlap with two s-orbitals of two hydrogen atoms and form  $sp^3$ -s bonds with hydrogen atoms which are known

as terminal hydrogen atoms in the diborane. This third hydrogen atom form bond with one  $sp^3$  hybrid orbital of the first boron atom and one  $sp^3$  hybrid orbital of the second boron atom which is empty hybrid orbital. Such type of overlapping cause of banana type bond as shown below :

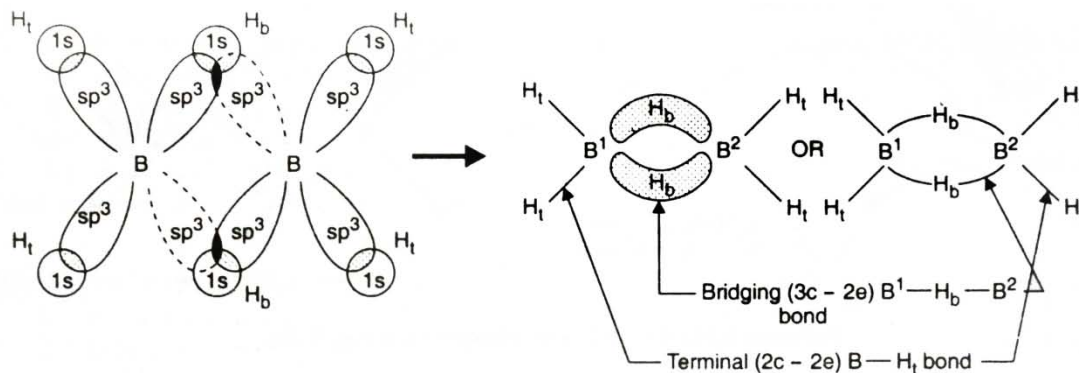

Figure : Fromation of two bridging 3c-2e in  $B^1-H_b-B^2$  and four rterminal 2c-2e in  $B-H_t$  bonds in diborane molecule.

The above idea gives a riew concept of the three centre- bond formation; in which the three nuclei are bonded by two electrons hence also known as 3c-2e i.e. three centres-two electrons while terminal hydrogen atoms form usual bond i.e. 2c-2e (two centres-two electrons) bond. Hence diborane may also be represented as shown alongside.

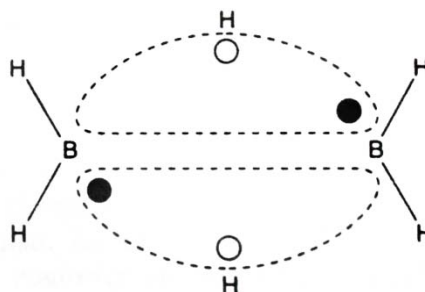

Figure : Diborane

In this figure dark circular spot (•) represents an electron originally on boron atom and empty spot (°) represents an electron originally on a hydrogen atom. Hence each loop links two boron atoms and one hydrogen atom.

### **Types of Bonds Found in Higher Boranes**

Higher boranes may contain few or all of the following types of bonds :

- i) Terminal (2c-2e) B-H bond : This is a normal covalent bond formed by overlapping of singly filled  $sp^3$ -hybrid orbital of boron atom and singly filled  $1s$ -orbital of hydrogen atom.
- ii) Direct (2c-2e) B-B bond : This is a normal covalent bond formed by overlapping of singly filled  $sp^3$ -hybrid orbitals of two boron atoms.
- iii) Bridging or Open (3c-2e) B-H-B bond: This type of bond is formed by overlapping of two  $sp^3$ -hybrid orbitals of two boron atoms (one singly filled and other empty) and  $1s$ -orbital of hydrogen atom.
- iv) Triply bridged or closed (3c-2e) B-B-B bond: This type of bond is formed by overlapping of three  $sp^3$ -hybrid orbitals of three boron atoms. Out of these one  $sp^3$ -hybrid orbital is empty. Thus each boron atom contributes  $2/3$  electrons for the formation of this bond.

### **Structure and Bonding in Some Higher Boranes**

The structure and bonding of some common boranes are given here.

- I) Tetraborane-10 ( $B_4H_{10}$ ) : In this molecule four B-atoms form slightly distorted octahedral geometry. In this molecule there are (i) four bridging (3c-2e) B-H-B bonds viz. B1-H-B3, B3-H-B2, B2-H-B4 and B4-H-B1; (ii) one direct (2c-2e) B-B bond (B1-B2) and (iii) six terminal (2c-2e) B-H bonds viz B1-H, B2-H, B3-H, B3-H, B4-H and B4-H bonds.



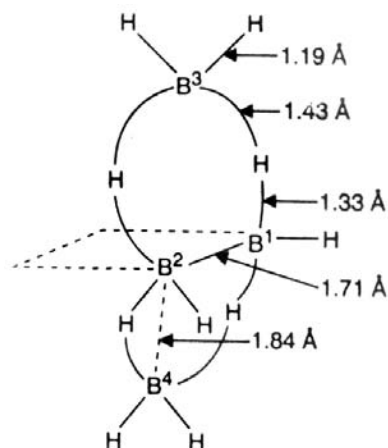

Figure : Structure of Tetraborane-10 ( $B_4H_{10}$ )

II) Pentaborane-9 ( $B_5H_9$ ) : In this molecule five B-atoms are situated at five corners of a square pyramida. Four B-atoms (B1,B2, B3 and B4) are at the base and fifth B-atom (B5) is at the apex of the pyramid. All these B-atoms form five terminal (2c-2e) B-H bonds. The basal B-atoms are bonded each other by four bridging (3c-2e) B-H-B bonds. The apex B-atom is bonded to the two B-atoms (B1 and B4) by two (2c-2e) B-B bonds. There is one closed (3c-2e) B-B-B bond also viz. B5-B3-B2 bond. Thus this molecule possesses all the four types of bonds discus d above.

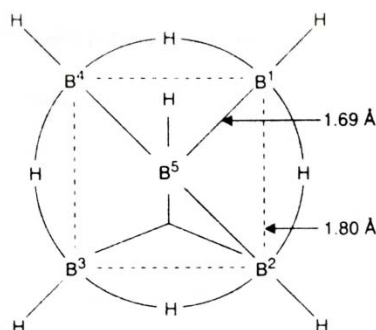

Figure : Structure of Pentaborane-9 ( $B_5H_9$ )

III) Pentaborane-11 ( $B_5H_{11}$ ): In thi molecule five B-atoms are situated at five corners of an asymmetrical square pyramidal. Four B-atoms (B1, B2, B3 and B4) are at the base and fifth B-atom (B5) is at the apex of the pyramid, which form two closed (3c-2e) B-B-B bonds viz B1-B4-B5 and B2-B3-B5.

Two basal B-atoms (B2, B3) and apical B-atom (B5) each are linked with two H-atoms by two terminal B-H bonds while the remaining B1 and B4 atoms are linked with one H-atom by one terminal B-H bond. Thus there are eight terminal (2c-2e) B-H bonds in this molecule. Except it there are three bridging (3c-2e) B-H-B bonds viz B1-H-B4, B4-H-B3 and B1-H-B2 bonds.

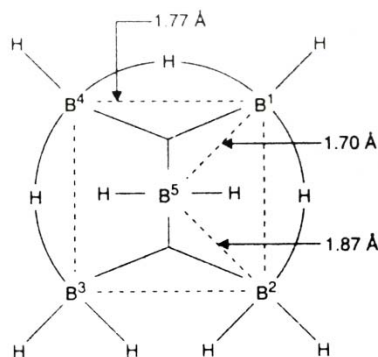

Figure : Structure of Pentaborane-11 ( $B_5H_{11}$ )

IV) Hexaborane-10 ( $B_6H_{10}$ ) : In this molecule six B-atoms are situated at the corners of a pentagonal pyramid. Five B-atoms are at the base of the pyramid and sixth B-atom (B6) is at the apex. The basal and apical B-atoms each are linked with six H-atoms by six terminal (2c-2e) B-H bonds. There are four bridging (3c-2e) B-H-B bonds viz B1-H-B2, B2-H-B3, B3-H-B4 and B4-H-B5. Except it there are two (2c-2e) B-B bonds viz B1-B5 and B3-B6, and two closed (3c-2e) B-B-B bonds viz B1-B2-B6 and B4-B5-B6 bonds also present in the molecule.

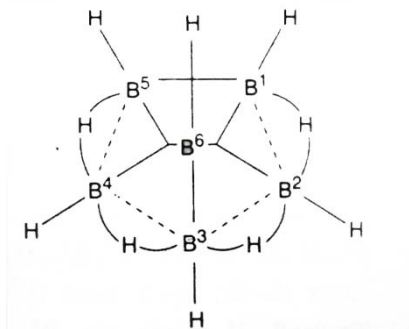

Figure : Structure of Hexaborane-10 ( $B_6H_{10}$ )

v) Decaborane-14 ( $B_{10}H_{14}$ ) : As revealed by X-ray analysis, in  $B_{10}H_{14}$  molecule the B-

atoms are arranged in two pentagonal pyramids with an edge common to both the pentagonal pyramids. This molecule consist (our bridging (3c-2e) B-H-B bonds (viz B5-H-B6, B6-H-B7, B8-H-B9 and B9-H-B10) in the open face. There are ten terminal (2c-2e) B-H bonds. In addition to these there are four (2c-2e) B-B bonds (viz B2-B5, B2-B7, B4-B8 and B4-B8) and four closed (3c-2e) B-B-B bonds viz B1-B2-B3, B1-B3-B4, B1-B5-B10 and B3-B7-B8 bonds).

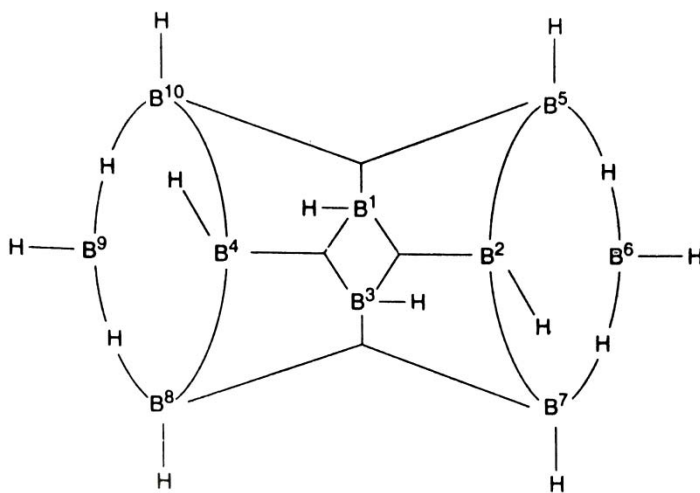
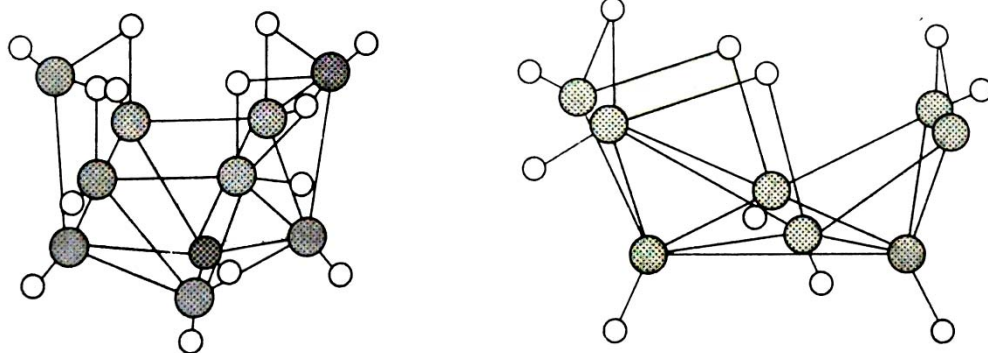

Figure : Structure of Decaborane-14 ( $B_{10}H_{14}$ )

The structures of  $B_8H_{12}$ ,  $B_9H_{15}$ ,  $B_{10}H_{14}$ ,  $B_{10}H_{16}$ ,  $B_{18}H_{22}$ ,  $B_{20}H_{16}$ ,  $B_{10}H_{10}^{2-}$  and  $B_{12}H_{12}^{2-}$  are also given below.



Decaborane-14 ( $B_{10}H_{14}$ )

Octaborane-12 ( $B_8H_{12}$ )

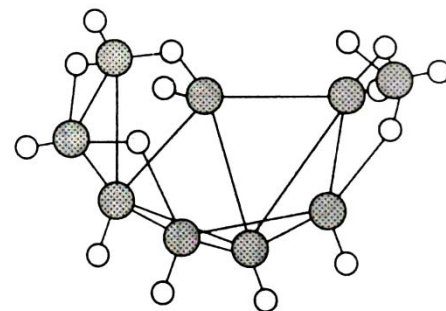
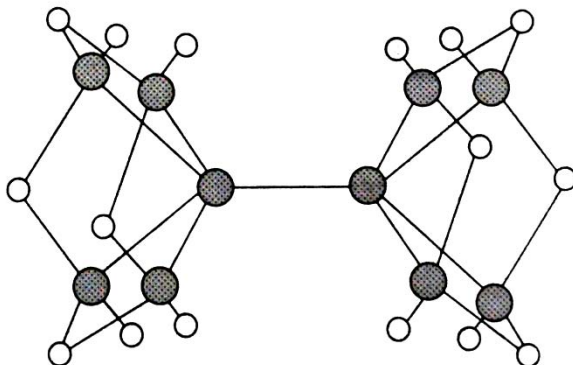

Decaborane-16 ( $B_{10}H_{16}$ )

Nonaborane-15 ( $B_9H_{15}$ )

## 10.6 Metalloborane

Borane-clusters, in which metals are present are known as 'Metalloboranes'. Many metalloboranes have been prepared. In some cases metal atom is attached with the borohydride ion through hydrogen bridge. The most common and important metalloborane group is one in which direct metal boron bond is present.

An important example of main group element metallocarborane is closo  $[B_{11}H_{11}AlCH_3]^{2-}$ . It is prepared by the action of trimethyl aluminium  $[Al(CH_3)_3]_2$  with  $Na_2[B_{11}H_{13}]$ :

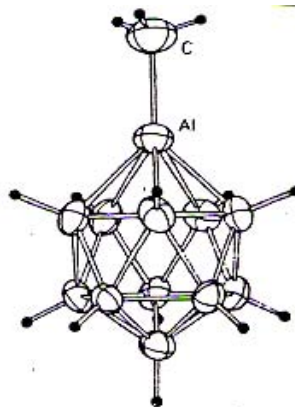
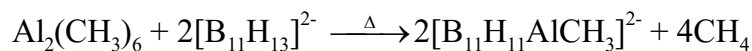
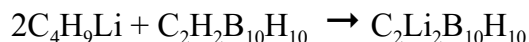
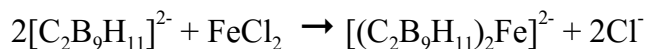

Figure: Closo  $[B_{11}H_{11}AlCH_3]^{2-}$

The hydrogen attached with carbon in closo-  $B_{10}C_2H_{12}$  is slightly acidic. This can be substituted by butyl lithium or Grignard's reagent to get lithium or magnesium metallocarboranes:



Similarly,  $[C_2B_9H_{11}]^{2-}$  ion, reacts with  $FeCl_2$ ,  $BrRe(CO)_5$  or  $BrMn(CO)_5$  to give Fe, Re or Mn derivatives:



There is a similar reaction with the hexacarbonyls of Cr, Mo and W under the influence of ultraviolet light, and the air sensitive products are of the type  $(C_2B_9H_{11})M(CO)_3^{2-}$  ( $M = Cr, Mo, W$ ). Closely related complexes of other transition metals (Co, Ni, Pd, Cu and Au) have also been made, including some with substituents on the ion.

In the first place formation of  $\pi$ -bonded complexes based on carborane structures is not restricted to the  $C_2B_9H_{11}^{2-}$  ion; there are a number formed on the same principle by  $CB_{10}H_{11}^{3-}$  and some of its amine-substituted derivatives (e.g.  $[(CB_{10}H_{11})_2Cr]^{3-}$  and  $C_2B_4H_6^{3-}$ ) also give complexes, and it may be noted, some of these are nido-anions. Thus  $[1,6-C_2B_7H_9)_2Co]^-$  has the structure shown below, the ion being derived from 1,3- $C_2B_7H_{13}$ .

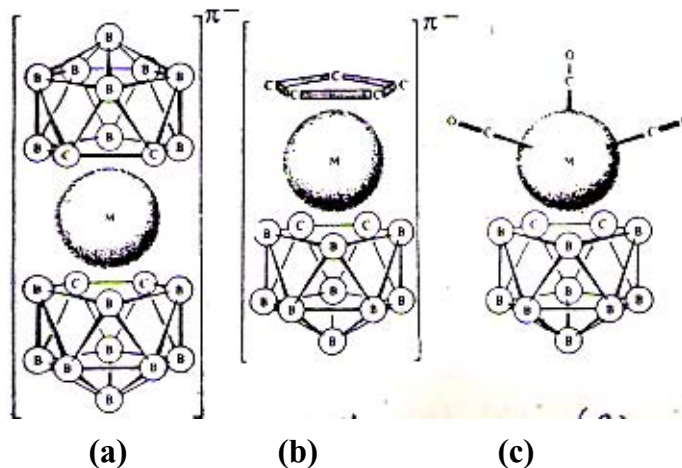

Figure: (a) Carbonyl metallocene, (b) Carbonyl Cyclopentadieny, (c) Carbonyl Carbonyl Compound

On the basis of Wade's rule, the structures of these metal derivatives may be known from their molecular formula and skeletal electrons. For example in  $B_3H_7[Fe(CO)_3]_2$ ,  $n=5$  ( $3B + 2Fe$ ) and skeletal electrons are 14. Hence it has nido structure corresponding to square pyramidal.

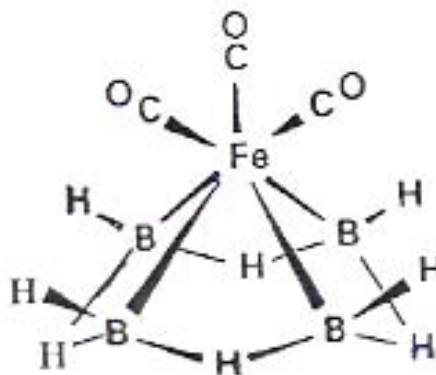

Figure : Structure of  $[Fe(CO_3)B_4H_8]$

#### 9.4.1 Properties

Just as the carboranes, lithio and Grignard's derivatives of metallo carbones give substitution reactions of organometallics, which include:

- (a) Formation of derivatives such as carboxylic acids, ester, alcohol, ketone, amines etc.

- (b) Synthesis of iodo and nitroso derivatives.
- (c) Elimination of Lithium halide-

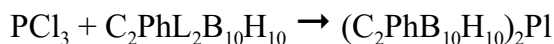

## 10.7 Carborane

carborane, any member of a class of organometallic compounds containing carbon (C), boron (B), and hydrogen (H). The general formula of carboranes is represented by  $\text{C}_2\text{B}_n\text{H}_{n+2}$ , in which  $n$  is an integer; carboranes with  $n$  ranging from 3 to 10 have been characterized. The first carboranes were produced in the 1950s, but the results were not declassified and published until 1962–63. Since then, many thousands of carboranes have been prepared, and they have been combined with transition metals to yield derivatives called metallocarboranes, some of which show catalytic activity.

### Structure and bonding of carboranes

The carboranes have polyhedral molecular structures based on networks of boron and carbon atoms, in which the carbon atoms occupy adjacent positions. As a result, the structures of carboranes and their derivatives are similar to those of the isoelectronic (possessing the same number of electrons) polyhedral boranes, and, like the boranes, they involve three-centre bonds as well as ordinary two-centre bonds. Their most significant structural feature is the covalent bonding of carbon simultaneously to five or six other atoms.

In addition, the nomenclature of carboranes employs the same structural prefixes (*closo*-, *arachno*-, etc.) as those of borane. The numbering of the atoms in carborane compounds begins with the apex atom of lowest coordination (i.e., with the fewest bonds), and polyhedral vertex atoms are numbered in a clockwise direction with the carbon atoms being given the lowest possible numbers. The best-studied carborane is *ortho*-carborane,  $\text{C}_2\text{B}_{10}\text{H}_{12}$ , made by reaction of acetylene with decaborane in the presence of diethyl sulfide. Its molecular structure resembles an

icosahedron with the 10 boron atoms and two adjacent carbon atoms forming the apices.

Carboranes are generally prepared by reaction of acetylene or acetylene derivatives with boronhydrides. The first three carboranes—trigonal bipyramidal 1,5- $C_2B_3H_5$ ; the 1,2- and 1,6- isomers of octahedral  $C_2B_4H_6$ ; and pentagonal pyramidal 2,4- $C_2B_5H_7$ —that were produced in the 1950s were generated in low yield by the reaction of pentaborane(9) with acetylene in a silent electric discharge. As is the case with boranes, the *nido*- and *arachno*-carboranes are less thermally stable and reactive toward air and chemical reagents than the corresponding *closo*-carboranes, most of which are stable to 400 °C (750 °F), although they may rearrange to more stable isomeric forms.

The three isomeric icosahedral *closo*-carboranes of formula  $C_2B_{10}H_{12}$  are unusual both in their ease of preparation and their stability in air. Not only has their chemistry been the most extensively studied of all carboranes, but their discovery ushered in the rapid development of the field. Although their systematic International Union of Pure and Applied Chemistry (IUPAC) name is *closo*-dicarbadodecaborane(12), the three isomers are often simply called *ortho*-, *meta*-, and *para*-carborane.

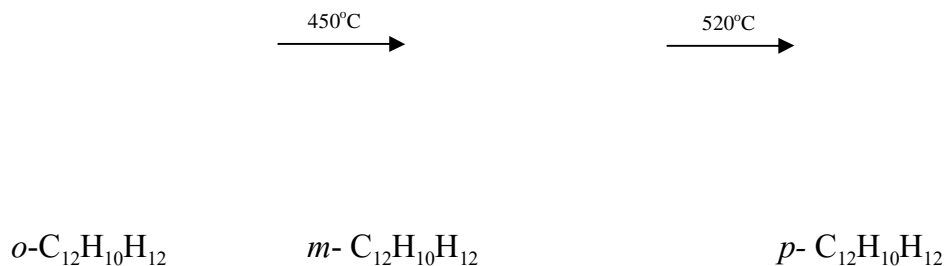

The most common carborane, the *ortho*-isomer, has been available in multikilogram quantities since the early 1970s and is best prepared by the reaction of acetylene,  $C_2H_2$ , with decaborane(14) in the presence of a Lewis base such as diethyl sulfide,



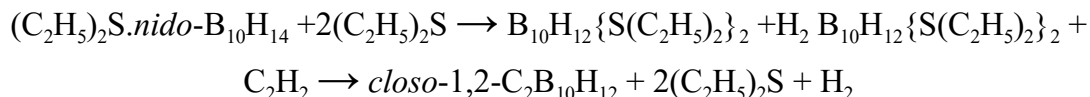

The two other isomers are prepared by thermal isomerization of the 1,2- (*ortho*-) isomer. Numerous derivatives of icosahedral *closo*-carboranes, especially of 1,2- $\text{C}_2\text{B}_{10}\text{H}_{12}$ , have been prepared by replacement of hydrogen atoms by other groups. Despite their stability toward heat and reagents, the American chemist M. Frederick Hawthorne in 1964 showed that they could be degraded to *nido*-carborane anions by reaction with strong bases in protonic solvents (those capable of donating  $\text{H}^+$  ions); for example,

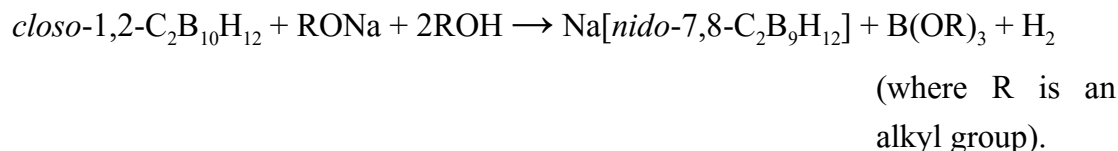

These *nido*-anionic cages, called dicarbollide ions (from Spanish *olla*, meaning “bowl”) led to the preparation of metallocarboranes with their own extensive chemistry.

### Nomenclature:

Rules for naming carboranes are as follows:

- i. First of all, give the positions and number of carbon atoms, then the type of carborane (either *closo* or *nido*) and finally the name of the borane from which the carborane is formally derived and the number of hydrogen atoms shown in bracket. For example  $\text{CB}_5\text{H}_9$  is name as monocarbonido hexaborane (9). Similarly, the three isomers of  $\text{C}_2\text{B}_{10}\text{H}_{12}$  are named as 1, 2; 1, 7 and 1, 12 dicarbo-*closo*-dodecaborane (12).
- ii. Number of atoms in these structure are counted by starting the numbering from that in the apical position and proceeding through successive rings in a clockwise direction.

This rule is important in naming the isomers.

### Closo-Carboranes or Closed Cage Carboranes

These carboranes are having general formula  $C_2B_nH_{n+2}$  ( $n=3$  to  $10$ ) in which the constituents are only terminal. These are isoelectronic with the corresponding  $[B_nH_n]^{2-}$  ions and have the same closed polyhedral structures, with one hydrogen atom bonded to each carbon and boron. No bridging hydrogen atoms are present in the  $C_2B_n$  skeleton. They are considered in three groups.

- a. small,  $n = 3 - 5$
- b. large,  $n = 6-10$  and
- c. dicarbo-closo-dodecaborone

**Preparation:**

- (a) The Small Closo Carboranes ( $C_2B_nH_{n+2}$  where  $n = 3$  to  $5$ )



Example - The closo hexaborane isomers,  $C_2B_nH_6$ ,

- (b) The Large Closo Carboranes ( $C_2B_nH_{n+2}$  where  $n = 6$  to  $9$ )

The first three members of this group of carboranes are obtained by the thermolysis of  $1,3 - C_2B_7H_{13}$  and  $1,3 - C_2B_8H_{14}$ .

Example :  $C_2B_6H_8$  is made from hexaborane (10) and dimethylacetylene. The structure of  $1,7 - Me_2C_2B_6H_6$  is based on the bicapped triangular prism. The carbon atoms are present one on the prism and the other above the face opposite.

- (c) Dicarbo-closo-dodecaborone:

Preparation: The orthocarborane is the only isomer which can be synthesized directly. However, it is synthesized by the base catalysed reaction of acetylenes with decaborane (14) or via  $B_{10}H_{12}L_2$ .

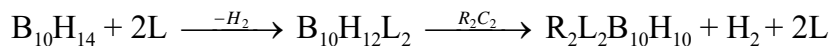

Example:  $C_2B_{10}H_{12}$  gives three isomeric structure - 1,2 (ortho), 1-7 (meta) and 1, 12 (para)

(II) Nido-Carboranes or Open Cage Carboranes

These structures are derived formally from one or other of several boranes and contain from one to four carbon atoms in the skeleton.

Examples:  $\text{CB}_5\text{H}_9$ ,  $\text{C}_2\text{B}_4\text{H}_8$ ,  $\text{C}_3\text{B}_3\text{H}_7$ ,  $\text{C}_4\text{B}_2\text{H}_6$  etc.

Preparation: The smaller nido-carboranes are generally prepared by reacting a borane with acetylene under mild conditions.

Example:  $\text{B}_5\text{H}_9$  and  $\text{C}_2\text{H}_2$  undergo reaction in the gas phase at  $215^\circ\text{C}$  to give mainly the nido-carborane 2,3 -  $\text{C}_2\text{B}_4\text{H}_8$  together with methyl derivatives of  $\text{CB}_5\text{H}_9$ .

The preparation method described above does not yield a single product but a mixture of several products whose separation is not an easy task. However some smaller nido-carboranes are prepared by the following specific methods:

- i. Mono carbo-nido-hexaborane (7)  $\text{CB}_5\text{H}_7$  is formed by passing silent electric discharge through 1-methyl pentaborane (9).
- ii. The only example isoelectronic with  $\text{B}_5\text{H}_9$  is 1,2-dicarbonyl - pentaborane(7),  $\text{C}_2\text{B}_3\text{H}_7$ , which is prepared as follows:

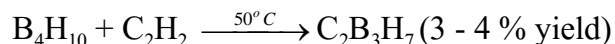

- ii. Monocarbonylhexaborane (9),  $\text{CB}_5\text{H}_9$  is formed from ethyldifluoroborane and lithium.

The nido-carboranes are formally related to  $\text{B}_6\text{H}_{10}$ . All are having eight pairs of electrons which are bonding the six cage atoms together.

### Large Nido-Carborane:

Dicarbo-nido-undecaborane,  $\text{C}_2\text{B}_9\text{H}_{13}$ , is the second member of the class of nido-carboranes  $\text{C}_2\text{B}_n\text{H}_{n+4}$  ( $n = 4$  or  $9$ ). The parent carborane and its substituted derivatives can be prepared by the base degradation of ortho-carborane (1,2-dicarbocloso-dodecaborane ( $\text{C}_2\text{B}_{10}\text{H}_{12}$ )).

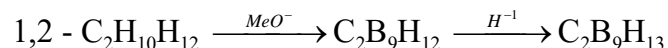

When  $C_2B_9H_{13}$  is heated, the closo-undeca-Borane (11) cage is formed.

---

## 10.9 Summary

---

This chapter discussed the boron group of the periodic table. One can know the properties of boron hydride, its structure, bonding in diborane, their synthesis and physical and chemical properties, various metalloborane, carboranes by reading this chapter.

---

## 10.10 Summary

---

1. Volatile solid: is the tendency of a substance to vaporize.
  2. Organometallic chemistry: It is the study of chemical compounds containing bonds between carbon and a metal.
  3. Dimer: A dimer is a chemical entity consisting of two structurally similar monomers joined by bonds that can be either strong or weak, covalent or intermolecular.
  4. Saturated hydrocarbon: hydrocarbon having no double and triple bond are considered as saturated hydrocarbon.
  5. Isoelectronicity: Two or more molecular entities are described as being isoelectronic with each other if they have the same number of electron or a similar electron configuration and the same structure, regardless of the nature of the elements involved.
- 

## 10.11 Review Questions

---

1. Write short note on boron hydride.
2. Discuss the classification of boranes.
3. Write detailed notes on preparation and conversion of boranes.
4. Discuss the structure of borane.
5. Write detailed notes on metalloboranes?
6. Give the nomenclature of carboranes.

---

## 10.12 eferences and Suggested Readings

---

1. Concise Inorganic chemistry- J.D. Lee (Blackwell Science) 2001
2. Inorganic Chemistry- F.A. Cotton (Interscience publisher) 2008
3. Inorganic chemistry, principles of structure and reactivity- James E. Huheey (Harper Collins college peublishers) 1993
4. Inorganic chemistry- G Sharpe, (Pearson printice hall) 2005
6. Inorganic chemistry- James E. House (Elsevier academic press) 2008
7. [en.wikipedia.org/](http://en.wikipedia.org/)

---

# Unit – 11 : Carbon Group

---

## Structure of Unit:

- 11.0 Objectives
- 11.1 Introduction
- 11.2 Carbon group
- 11.3 Allotropes of Carbon
- 11.4 Intercalation compounds of graphite
- 11.5 Carbon nanotubes
- 11.6 Classification of Organometallic Compounds
- 11.7 Organometallic Compounds of Silicon
- 11.8 Organometallic Compounds of Tin
- 11.9 Organometallic Compounds of Lead (Organolead)
- 11.10 Summary
- 11.11 Question

---

## 11.0 Objectives

---

At the end of the unit learner will be able to

- Familiar with C-group.
- Learn the allotropes of carbon.
- Understand about Intercalation compounds of graphite.
- Increase knowledge about carbon nanotubes.
- Familiar with organometallic compounds

---

## 11.1 Introduction

---

Chapter deals with increasing the knowledge of learner for carbon family and its compound, their synthesis, reactions and structure. Chapter also explain brief about carbon nanotubes with is a matter of recent research. Alongwith these chapter also highlights the organometallic compounds of carbon family.

---

## 11.2 Carbon group

---

The carbon family, group 14 in the p block, contains carbon (C), silicon (Si), germanium (Ge), tin (Sn), lead (Pb), and Flerovium (Fl). These elements have only two electrons in the outer most p orbital. That is, their valence electron configuration is  $ns^2np^2$ . They tend to have oxidation states of +4 and, for the heavier elements, +2 due to the inert pair effect. Members of this group follow well to general periodic trends. The atomic radii increase as you move down the group, and ionization energies decrease. Metallic properties increase as you move down the group. Carbon is a non-metal; silicon and germanium are metalloids; and tin and lead are poor metals. Although their devotion to periodic trends, the properties of the Carbon family vary greatly. Carbon is a non-metal. Tin and Lead behave entirely as metals. In their elemental solid state, Group 14 metalloids, silicon and germanium, act as electrical semiconductors, although silicon is mainly non-metallic. Their electrical conductivity can be affected in various degrees by doping - the addition of Group 13 or Group 15 elements in various concentrations to the Group 14 solid matrix. These semiconductor properties have wide application for circuitry components in the electronics industry, such as diodes, transistors, and integrated circuit chips.

Element	Symbol	Atomic No.	Atomic Mass	Classification	Electron Configuration
Carbon	C	6	12.011	Non-metal	$[\text{He}]2s^22p^2$
Silicon	Si	14	28.0855	Metalloid	$[\text{Ne}]3s^23p^2$

Germanium	Ge	32	72.61	Metalloid	[Ar]3d <sup>10</sup> 4s <sup>2</sup> 4p <sup>2</sup>
Tin	Sn	50	118.710	Metal	[Kr]4d <sup>10</sup> 5s <sup>2</sup> 5p <sup>2</sup>
Lead	Pb	82	207.2	Metal	[Xe]4f <sup>14</sup> 5d <sup>10</sup> 6s <sup>2</sup> 6p <sup>2</sup>
Flerovium	Fl	114	287	Metal	[Rn]5f <sup>14</sup> 6d <sup>10</sup> 7s <sup>2</sup> 7p <sup>2</sup>

Carbon is an important non-metallic element. It is the sixth most abundant element in the universe. It can exist in the free state (allotropes) or in the form of its compounds. It is the major chemical constituent of most organic matter. Carbon is the second most common element in the human body after oxygen. Carbon is present in coal, oil and natural gas. Main natural sources of carbon and its compound which are industrially important are coal, petroleum and natural gas which contribute to our national economy in a big way. Carbon also occurs in a numbers of minerals. Carbon occurs in free state (i.e. not combined with any other element) in allotropic forms. Allotropes are different forms of the same element in the same physical state, Carbon has several allotropes, three of which are common.

---

### 11.3 Allotropes of Carbon

---

**Amorphous** carbon is coal and soot. The carbon molecules are covalently bonded, but there is no order or arrangement.

**Graphite** occurs when carbon forms flat covalent networks. These flat "sheets" are not bonded to each other, making them free to slide past each other. Graphite composes the "lead" in pencils.

**Diamond** occurs when carbon forms a three-dimensional covalent network. Diamonds are much different from graphite and amorphous carbon. They are transparent, brilliant-looking, and incredibly hard. Diamond only forms at heat and intense pressures.

There are also several rare and exotic allotropes of carbon, including:

**Buckyballs**, or fullerenes, are spherical shaped balls of carbon. Covalent bonds join the carbon atoms into a soccer ball pattern that looks much like the geodesic



domes of Buckminster Fuller. The most common buckeyball has the molecular formula  $C_{60}$ . Buckeyballs are large enough for a small atom to get trapped inside.

**Lonsdaleite** forms upon meteorite impact with the Earth.

Carbon **nanotubes** are incredibly small but rigid tubes made of carbon. They are created in labs and are a subject of research.

---

## 11.4 Intercalation compounds of graphite

---

Graphite intercalation compounds (GICs) are complex materials having formula  $XC_y$  where element or molecule X is inserted (intercalated) between the graphite layers. In this type of compound, the graphite layers remain largely intact and the guest molecules or atoms are located in between. When the host (graphite) and the guest X interact by charge transfer the in-plane electrical conductivity generally increases. This process is largely relied upon in commercial lithium-ion batteries as a reversible charge storage mechanism. When the guest forms covalent bonds with the graphite layers as in fluorides or oxides the conductivity decreases as the conjugated  $sp^2$  system collapses. In a graphite intercalation compound not every layer is necessarily occupied by guests. In so-called stage 1 compounds, graphite layers and intercalated layers alternate and in stage 2 compounds, two graphite layers with no guest material in between alternate with an intercalated layer. The actual composition may vary and therefore these compounds are an example of non-stoichiometric compounds. It is customary to specify the composition together with the stage.

At the first stage, binary graphite-metal intercalation have stoichiometry  $XC_8$  for the large metals ( $X = K, Rb$  and  $Cs$ ) and  $XC_6$  for small ones ( $X = Li, Sr, Ba, Eu, Yb$  and  $Ca$ ).

### Calcium graphite

Bulk samples of calcium graphite  $CaC_6$  are obtained by immersing highly oriented pyrolytic graphite in a well-chosen liquid Li–Ca alloy for long time (10 days at 350 °C). The crystal structure of  $CaC_6$  belongs to the R-3m space group. The graphite interlayer distance increases upon Ca intercalation from 3.35 to 4.524 Å, and the

carbon-carbon distance increases from 1.42 to 1.444 Å. Among the superconducting graphite intercalation compounds,  $\text{CaC}_6$  exhibits the highest critical temperature  $T_c = 11.5 \text{ K}$ , which further increases under applied pressure (15.1 K at 8 GPa).

### **Potassium graphite**

The  $\text{KC}_8$  form of potassium graphite is one of the strongest reducing agents known. It is prepared under inert atmosphere by melting potassium over graphite powder. The potassium is absorbed into the graphite and its color changes from black to bronze. The resulting solid is also quite pyrophoric, and explodes on contact with water. A new essential application for potassium graphite was introduced by the invention of the potassium-ion battery. Like the lithium-ion battery, the potassium-ion battery should use a carbon-based anode instead of a metallic anode. In this circumstance, the stable structure of potassium graphite is an important advantage. Heating  $\text{KC}_8$  leads to the formation of a series of decomposition products as the K atoms are eliminated, ultimately giving the blue compound  $\text{KC}_{60}$ :



### **Carbon fluorides**

Carbon monofluoride is denoted as  $(\text{CF})_x$  and used as a cathode material in one type of primary (non-rechargeable) lithium batteries. It is prepared by reaction of gaseous fluorine with graphitic carbon at 215–230 °C. The color is greyish, white, or yellow. The bond between the carbon and fluorine atoms is covalent. The compound is not electrically conductive which makes the addition of conductive fillers necessary for battery use. Tetracarbon monofluoride ( $\text{C}_4\text{F}$ ) is prepared by reacting gaseous fluorine mixed with hydrogen fluoride with graphite at room temperature. The compound has a blackish-blue color.

### **Graphite bisulfate and graphite perchlorate**

The intercalation compounds graphite bisulfate and graphite perchlorate can be made by reacting graphite with strong acids in the presence of oxidizing agents, causing the graphite to lose electrons and become positively charged. Graphite bisulfate,  $[\text{C}_{24}]^+[\text{HSO}_4]^-$ , is made by reacting graphite with concentrated sulfuric

acid and a little nitric acid or chromic acid. The analogous graphite perchlorate can be made similarly by reaction with perchloric acid. Both graphite bisulfate and graphite perchlorate are better conductors as compared to graphite, as predicted by using a positive-hole mechanism.

---

## 11.5 Carbon nanotubes

---

### Structures, properties, production techniques

With the discovery of fullerenes in 1985 by Kroto, Heath, O'Brien, Curl, and Smalley and the facile synthesis developed by Kraetschmer et al., a new class of molecules has been discovered that build up closed cages with dimensions in the order of angstroms. The most well-known representative of this new allotrope is the  $C_{60}$ -molecule.

In 1991, on the optimization of the fullerene-synthesis by arc-discharges Sumio Iijima found small tubes by means of transmission electron microscopy (TEM). They consisted of concentric layers of graphite (so-called Multi Walled Carbon Nanotubes, MWNT). Only two years later, he discovered – independent from Donald Bethune – nanotubes composed of a single layer (Single Walled Nanotubes (SWNT)) in the ashes of his synthesis-reactor.

### Carbon Nanotube structures and forms

The structure of carbon nanotubes can be visualized by rolling up a graphite sheet plane to a tube. According to Dresselhaus and co-workers, the crystalline structure of CNTs can be characterized by the (chiral) roll-up vector  $R$  within a corresponding graphite sheet plane.  $R = ma + nb$  ( $m, n \in \mathbb{N}$ ), with vectors  $a$  and  $b$  describing the base unit of the graphite sheet plane. The roll-up vector results from the difference between the two grid points of the graphite lattice that coincide in a single grid point of the nanotube on the imaginary roll-up. The length defines the perimeter, the angle  $\vartheta$  the helicity (chirality) of the nanotube.

### **Chirale, Armchair-, Zigzag-Nanotubes**

Aside from chiral CNTs, two achiral highly symmetric types of nanotubes can be determined. For  $m = n$  ( $\theta = 30^\circ$ ) the tubes are called “armchair”-nanotubes and for either  $m$  or  $n = 0$  ( $\theta = 0^\circ$ ) they are referred to as “zig-zag“-nanotubes, following the hexagonal arrangement of the carbon atoms along the perimeter, respectively.

### **SWNT, DWNT, MWNT**

Alongside with single walled carbon nanotubes (SWNT), double walled carbon nanotubes (DWNT) as well as multi walled carbon nanotubes (MWNT) have been identified. The tubes are thereby arranged in a concentric manner.

### **Properties of Carbon Nanotubes**

Carbon nanotubes feature a number of extraordinary properties, amongst which are-

- high electric conductivity
- high thermal conductivity
- mechanical strength
- thermal resistivity / stability
- actuational properties at low voltages
- field emission

### **Production techniques**

Meanwhile mainly three routes of synthesis with different variants have been established. The arc-discharge method, laser-ablation, and chemical vapor deposition (CVD). The latter is oftentimes performed in a plasma enhanced manner (PECVD).

### **Potential Applications of Carbon Nanotubes**

Carbon Nanotube Technology can be used for a wide range of new and existing applications:

- Conductive plastics
- Structural composite materials
- Flat-panel displays
- Gas storage
- Antifouling paint
- Micro- and nano-electronics
- Radar-absorbing coating
- Technical textiles
- Ultra-capacitors
- Atomic Force Microscope (AFM) tips
- Batteries with improved lifetime
- Biosensors for harmful gases
- Extra strong fibers

---

## 11.6 Classification of Organometallic Compounds

---

The organometallic compounds are classified into different types based on the nature of metal-carbon bonding. Carbon can form both ionic bonds with electropositive elements as well as covalent bonds with several main group and d-block elements.

**(i) Metal-carbon Ionic Bonds :** The most electropositive elements (Na, K etc.) form ionic organometallic compounds. For example, the crystalline solid (close packed hexagonal) of methylpotassium ( $K^+CH_3^-$ ) has isolated methyl anions ( $CH_3^-$ ) and metal cations ( $K^+$ ).

**(ii) Metal-Carbon Bridge Bonding :** The light electropositive elements (e.g. Li, Be, Mg, Al) form organometallic compounds such as MeLi,  $Me_2Mg$ ,  $Ph_3Al$  etc. These compounds do not exist as monomers rather form oligomers, or polymers, namely,  $(MeLi)_4$ ,  $(Me_2Mg)_n$ ,  $(Ph_3Al)_2$  involving bridging by alkyl or aryl groups.

This bridge formation is similar to that in boranes which involve two electron-three center bonds. The metal-carbon bonds have considerable covalent character.

**(iii) Metal-Carbon Two Electron Covalent Bonds:** The main group elements form binary alkyls and aryls,  $MR_n$  which have single two electron M–C bonds, the polarity of which depends on their electronegativity differences. For example, Al–C bonds in  $Me_3Al$  are more polar ( $\chi_C - \chi_{Al} = 2.5 - 1.6 = 0.9$ ) than B–C bonds in  $Me_3B$  ( $\chi_C - \chi_B = 2.5 - 2.1 = 0.4$ ). The M–C bond strength decreases with increase in atomic number among main group elements. This difference is due to more effective overlap of carbon ( $2s/2p$ ) orbitals with the metal in the same row, rather than with the metal down the group, which has more diffuse s and p-orbitals.

**(iv) Metal – Carbon Multiple bonds:** The multiple bond formation between carbon and other main group elements is uncommon. Phosphorus and silicon form  $R_3P=CH_2$  and  $R_2C=SiR_2'$  compounds. The latter however, do not exist as monomers, rather form oligomers or polymers. However, the use of bulky R/R' groups help to prepare monomers. Multiple bonds are more common with transition elements. Tungsten compounds of type,  $(OC)_5W=C(OMe)Me$ , and  $(ButO)_3W \equiv Cet$ , represent some examples. The suitable metal d-orbitals and carbon 2p orbitals for  $\Pi$ -overlap are engaged in multiple bonding.

**(v) Metal–Carbon  $\Pi$ - Bonds with Unsaturated Hydrocarbons:** Organic compounds are known to form bonds via filled  $\Pi$  electrons, as for example, first observed in ferrocene, and Zeise's salt. It is essential that metal should have filled suitable orbitals which can form back-bonds ( $\Pi$ -bonds) to empty  $\Pi^*$  orbitals centered on the organic ligand. A large number of  $\Pi$  complexes have been prepared with d-block elements, to a lesser extent with the lanthanides and actinides, and only small number with main group elements. Cyclopentadiene and cyclooctatetraene are some organic compounds which have formed a number of complexes with various elements. The bonding is predominantly ionic in case of main group, polar in case of f-block, and covalent in case of d-block elements.

---

## 11.7 Organometallic Compounds of Silicon

---

Organosilicon compounds are organic compounds containing carbon–silicon bonds. Most organosilicon compounds are similar to the ordinary organic compounds, being colourless, flammable, hydrophobic, and stable. The carbosilicon silicon carbide is an inorganic compound. Organosilicon compounds are widely encountered in commercial products. Most common are sealants, caulks, adhesives, and coatings made from silicones.

### Synthesis

The bulk of organosilicon compounds derive from organosilicon chlorides  $(\text{CH}_3)_{4-x}\text{SiCl}_x$ . These chlorides produced by the "Direct process", which entails the reaction of methyl chloride with a silicon-copper alloy. The main and most sought-after product is dimethyldichlorosilane:

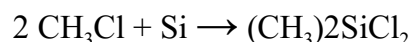

A variety of other products are obtained, including trimethylsilyl chloride and methyltrichlorosilane. About 1 million tons of organosilicon compounds are prepared annually by this route. The method can also be used for phenyl chlorosilanes.

### Reactions

Si–O bonds are much stronger (809 kJ/mol compared to 538 kJ/mol) than a typical C–O single bond. The favorable formation of Si–O bonds drive many organic reactions such as the Brook rearrangement and Peterson olefination. Compared to the strong Si–O bond, the Si–F bond is even stronger.

**The Brook rearrangement** in organic chemistry is a rearrangement reaction in which an organosilyl group switches position with a hydroxyl proton over a carbon to oxygen covalent bond under the influence of a base. The reaction product is a silyl ether.

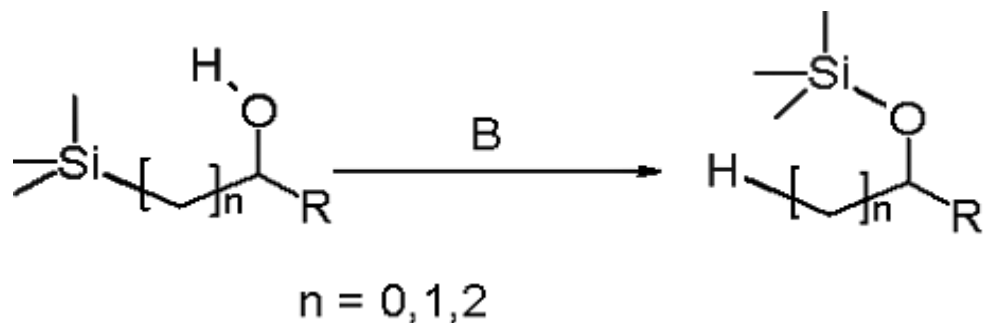

### The Brook rearrangement Reaction

The silyl substituents can be aliphatic (methyl) or aromatic (phenyl) and the alcohol is secondary or tertiary with aliphatic or aryl groups. The base is an amine, sodium hydroxide, an organolithium reagent or an alkali metal alloy such as sodium/potassium. When the reactant is a silylmethanol the reaction is a 1,2-brook rearrangement but rearrangements over larger carbon skeletons are also possible.

**The Peterson olefination** (also called the Peterson reaction) is the chemical reaction of  $\alpha$ -silyl carbanions 1 with ketones (or aldehydes) to form a  $\beta$ -hydroxysilane 2 which eliminates to form alkenes 3.

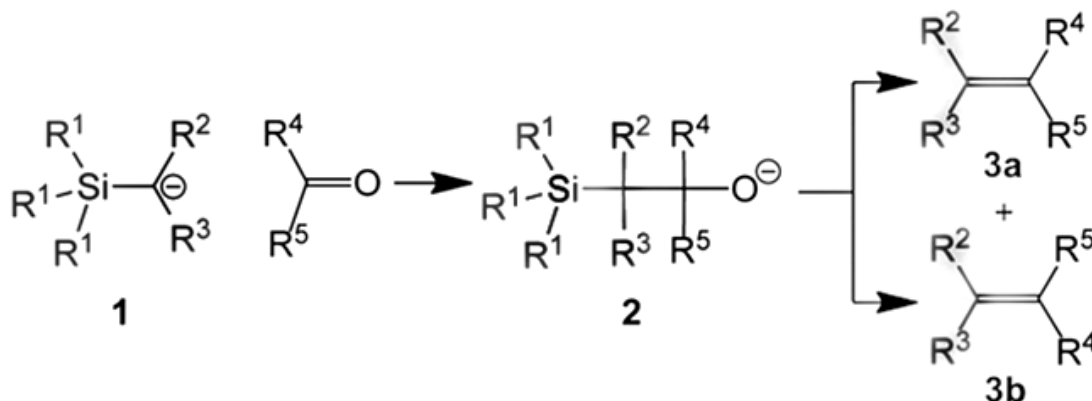

### The Peterson olefination Reaction

#### Structure

In organosilanes Si atom is in  $sp^3$  hybridization thus silicon atom can bond with 4 other atoms to form a compound for example Trimethylsilane or trimethylsilyl hydride, is a compound with the formula  $C_3H_{10}Si$ , or with the structural formula



(CH<sub>3</sub>)<sub>3</sub>SiH. In this molecule three *sp*<sup>3</sup> hybrid orbital of Si bonded with three CH<sub>3</sub> molecules and fourth *sp*<sup>3</sup> hybrid orbital of Si is bonded with H-atom,

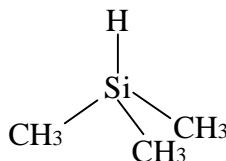

**Structure of Trimethylsilane**

## 11.8 Organometallic Compounds of Tin

### Synthesis

Mono-, di-, tri-, and tetra-organo derivatives of tin(IV), viz. R<sub>4-n</sub>Sn (n = 3, 2, 1, 0) are known, while tin(II) has formed only R<sub>2</sub>Sn(II). A brief account of methods of preparation is described below. In general tin-carbon bonds can be formed by four different methods given below.

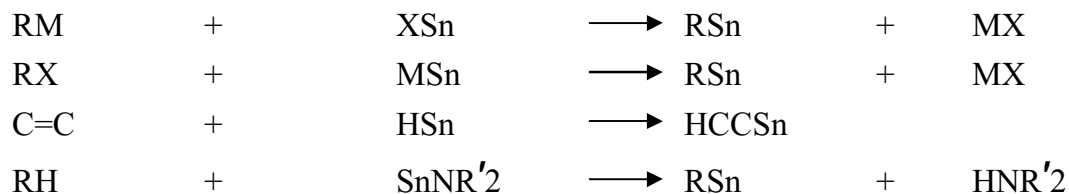

The alkylation of SnCl<sub>4</sub> using a Grignard reagent in 1: 4 molar ratio in THF at 80°C, or toluene (containing a small amount of diethyl ether to solvate Grignard reagent) leads to nearly complete alkylation yielding R<sub>4</sub>Sn. If diethyl ether is solvent, and Grignard reagent is not in excess, some alkyltin chlorides also accompany the tetraalkyltins, which, however, can be removed by precipitating them using dry NH<sub>3</sub>, as insoluble complexes, R<sub>n</sub>SnCl<sub>4-n</sub>(NH<sub>3</sub>)<sub>m</sub> (n = 1-3; m = 1-2).



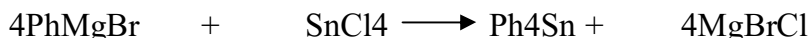

Phenyl-, and vinyl- tin compounds can be prepared in the same way. Organoaluminium compounds can also be used for alkylation of  $\text{SnCl}_4$  and no solvent is needed in this method. Both  $\text{Bu}_4\text{Sn}$  and  $\text{Oct}_4\text{Sn}$  are industrially prepared by this method in the absence of any solvent. The only limitation is that resulting  $\text{AlCl}_3$  complexes with di- and tri-alkyltinchlorides formed in the reaction, which inhibit further alkylation to tetraalkyltins. This can be readily avoided if a solvent such as ether or amine are added to the reaction mixture which form strong complexes with alkyltin chlorides and thus alkylation goes to completion.

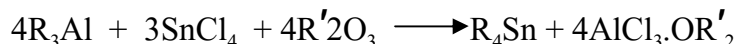

Tetraorganotin(IV) compounds are the sources for preparing organotin halides ( $\text{X} = \text{Cl}, \text{Br}$ ).  $\text{R}_3\text{SnCl}$  is formed when  $\text{R}_4\text{Sn}$  and  $\text{SnCl}_4$  are heated in 3:1 molar ratio; similarly,  $\text{R}_2\text{SnCl}_2$  is prepared from  $\text{R}_4\text{Sn}$  and  $\text{SnCl}_4$  in 1:1 molar ratio. The use of excess  $\text{SnCl}_4$  forms  $\text{RSnCl}_3$ . Direct reaction of methyl chloride with tin metal at  $315^\circ\text{C}$  catalyzed by Cu metal, also forms predominantly,  $\text{Me}_2\text{SnCl}_2$  (75%), along with other organotin halides. Several other organotin compounds can be prepared from  $\text{R}_n\text{SnCl}_{4-n}$ , by reaction with a suitable nucleophilic reagent, the description of some will be given in section on reactions.



## Properties

Tetraalkyl- and tetraaryl-organotin compounds are usually liquids, or solids and are thermally stable up to 200 °C. They do not react with air or water rapidly, rather very slowly they are degraded to inorganic tin compounds. Their melting points vary over a wide range depending on the type organic group bonded to Sn atom. Organotin halides,  $R_nSnX_{4-n}$  are generally soluble in organic solvents for  $X = Cl$  to  $I$  and are insoluble for  $X = F$ . Again they are insoluble in water except some methyltin halides for  $X = Cl$  to  $I$ . In solution and gas states, organotin halides exist as monomers.

### Reactions

The Sn-C bond cleavage of tetraorganotin compounds occurs with protic acids such as carboxylic acids, halogens etc. The rupture involves nucleophilic attack at tin center and electrophilic attack at carbon. The reaction of alkyltin compounds with carboxylic acids forms alkyltin carboxylates and the replacement of one R group occurs easily. For  $R = Me$ ,  $R' = CF_3$ , the corresponding products are  $M_{e3}Sn(OCOCF_3)$  and  $MeH$ . It may be noted that tetravinyltin and tetraallytin  $\{(CH_2=CHCH_2)_4Sn\}$  react with carboxylic acids by replacing all the four vinyl or ally groups by carboxylates (equations 81 and 82). Reaction of  $R_4Sn$  with halogens form  $R_3SnX$  and  $RX$ . ( $R = Ph, Me, PhCH_2$  etc.;  $X = Br, I$ ). This reaction occurs via homolytic cleavage of Sn-R bond

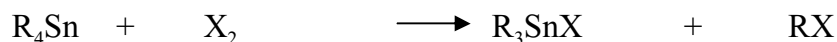
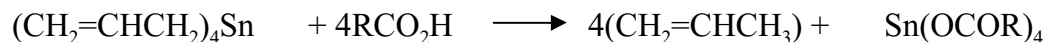

The organotin chlorides are used for the preparation of a number other organotin derivatives. The chloride of  $R_3SnCl$  can be readily replaced by a number of

nucleophilic reagents such as, OH<sup>-</sup>, H<sup>-</sup>, N<sub>3</sub><sup>-</sup>, R'S<sup>-</sup>, S<sub>2</sub><sup>-</sup>, CN<sup>-</sup>, NCS<sup>-</sup>, NCO<sup>-</sup>, R'<sub>2</sub>N<sup>-</sup>, R'COO<sup>-</sup>, OR' etc as shown below.



X<sup>-</sup> = CN<sup>-</sup>, NCS<sup>-</sup>, NCO<sup>-</sup>, R'O<sup>-</sup>, R'CO<sub>2</sub><sup>-</sup>, R'<sub>2</sub>N<sup>-</sup>, R'S<sup>-</sup>, N<sub>3</sub><sup>-</sup>, F<sup>-</sup>, Br<sup>-</sup>, I<sup>-</sup>



### Structure and Bonding

Organotin(IV) compounds of type, RSnX<sub>3</sub>, R<sub>2</sub>SnX<sub>2</sub>, R<sub>3</sub>SnX, and R<sub>4</sub>Sn (X = halide /pseudo halide) generally have simple tetrahedral geometry, or some distortions in geometry due to unequal bond lengths and angles, which may be due to packing effect in the solid state. Steric effect within the molecule may also alter bond parameters. However, polymerization can occur particularly with R<sub>2</sub>SnF<sub>2</sub> type compounds where in fluoride acts as a bridging group, and R groups stay non-bridging terminal. If the anion such as NO<sub>3</sub><sup>-</sup> is present, then the geometry may change from tetrahedral to trigonal bipyramid, or octahedral depending on whether one or two O atoms are coordinating. If the organotin compounds form adducts with Lewis bases, then the geometry will be either trigonal bipyramid (e. g. R<sub>3</sub>SnX·L) or octahedral (e. g. R<sub>2</sub>SnX<sub>2</sub>·L<sub>2</sub>). Further, bonding is a simple matter, and here tin atom can be considered sp<sup>3</sup> hybridized and each sp<sup>3</sup> hybrid orbital interacts with sp<sup>3</sup> orbitals of R group, or X group as the case may be. R groups may have sp<sup>2</sup> or sp - hybridized carbon atoms and bonding arguments can be similarly taken into account. Below figure shows structures of some organotin

compounds. Dimers like  $R_3Sn-X-SnR_3$  have bridging O or S atoms, with tetrahedral geometry around each Sn atom, as shown below.

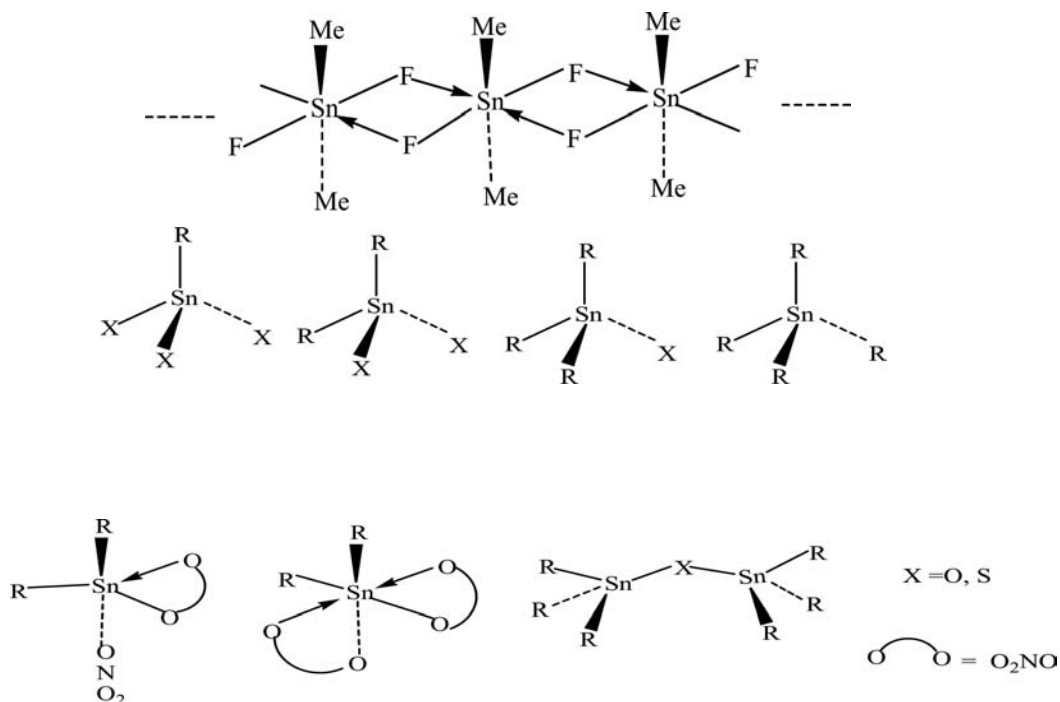

### Structures of some organotin compounds

## 11.9 Organometallic Compounds of Lead (Organolead)

Organolead compounds are chemical compounds containing a chemical bond between carbon and lead. Sharing the same group with carbon, lead is tetravalent. Going down the carbon group the C–X (X = C, Si, Ge, Sn, Pb) bond becomes weaker and the bond length larger. The C–Pb bond in tetramethyllead is 222 pm long with a dissociation energy of 49 kcal/mol (204 kJ/mol). For comparison the C–Sn bond in tetramethyltin is 214 pm long with dissociation energy 71 kcal/mol (297 kJ/mol). The dominance of Pb(IV) in organolead chemistry is remarkable because inorganic lead compounds tend to have Pb(II) centers. The reason is that with inorganic lead compounds elements such as nitrogen, oxygen and the halides have a much higher electronegativity than lead

itself and the partial positive charge on lead then leads to a stronger contraction of the 6s orbital than the 6p orbital making the 6s orbital inert; this is called the inert pair effect. By far the most important organolead compound is tetraethyllead, formerly used as an anti-knocking agent. The most important lead reagents for introducing lead are lead tetraacetate and lead chloride. The use of organoleads is limited partly due to their toxicity, although the toxicity is only 10% of that of palladium compounds.

### Synthesis

Organolead compounds can be derived from Grignard reagents and lead chloride. For example methylmagnesium chloride reacts with lead chloride to tetramethyllead, a water-clear liquid with boiling point 110 °C and density 1.995 g/cm<sup>3</sup>. Reaction of a lead(II) source with sodium cyclopentadienide gives the lead metallocene, plumbocene. Certain arene compounds react directly with lead tetraacetate to aryl lead compounds in an electrophilic aromatic substitution. Other compounds of lead are organolead halides of the type R<sub>n</sub>PbX(4-n), organolead sulfinates (R<sub>n</sub>Pb(OSOR)(4-n)) and organolead hydroxides (R<sub>n</sub>Pb(OH)(4-n)). Typical reactions are:

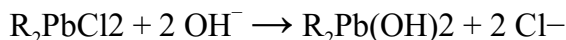
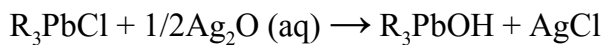
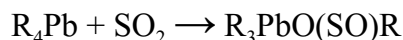
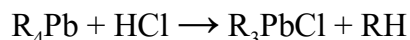

R<sub>2</sub>Pb(OH)<sub>2</sub> compounds are amphoteric. At pH lower than 8 they form R<sub>2</sub>Pb<sup>2+</sup> ions and with pH higher than 10, R<sub>2</sub>Pb(OH)<sub>3</sub><sup>-</sup> ions.

Derived from the hydroxides are the plumboxanes:



which give access to polymeric alkoxides:

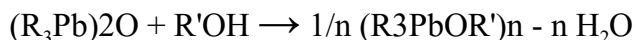

## Reactions

The C–Pb bond is weak and for this reason homolytic cleavage of organolead compounds to free radicals is easy. In its anti-knocking capacity, its purpose is that of a radical initiator. General reaction types of aryl and vinyl organoleads are transmetalation for instance with boronic acids and acid-catalyzed heterocyclic cleavage. Organoleads find use in coupling reactions between arene compounds. They are more reactive than the likewise organotins and can therefore be used to synthesise sterically crowded biaryls. In oxyplumbation, organolead alkoxides are added to polar alkenes:

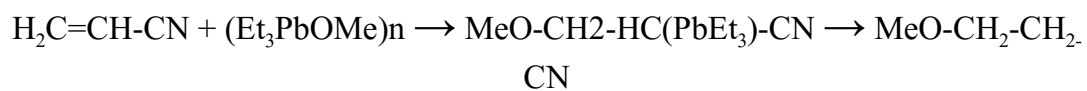

The alkoxide is regenerated in the subsequent methanolysis and, therefore, acts as a catalyst.

## Structure

In organolead Pb-atom is also in  $sp^3$  hybridization thus Pb-atom can bond with 4 other atoms to form a compound for example Tetraethyllead. In this molecule all four  $sp^3$  hybrid orbital of Pb bonded with four  $\text{C}_2\text{H}_5$  molecules and form Tetraethyllead molecule.

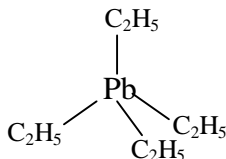

**Structure of Tetraethyllead**

---

## 11.10 Summary

---

This Chapter increase the knowledge of learner for carbon family, its compound and organometallic compounds, their synthesis, reactions and structure, Chapter also explain brief about carbon nanotubes with is a matter of recent research.

---

### **11.11 Review Question**

---

1. Define carbon nanotubes.
  2. What are organometallic compounds. Give synthesis, reaction and structure of organometallic compounds of Tin.
  3. What are intercalation compounds of graphite, explain.
  4. Define C- atom.
  5. Explain periodic trend in carbon family.
- 

### **11.12 Reference and Suggested readings**

---

- 1 Concise Inorganic chemistry- J.D. Lee (Blackwell Science) 2001
- 2 Inorganic Chemistry- F.A. Cotton (Interscience publisher) 2008



---

## Unit - 12 : Nitrogen Group

---

### Structure of Unit:

- 12.0 Objectives
- 12.1 Introduction
- 12.2 Nitrogen group
- 12.3 Nitrogen activation
- 12.4 Boron nitride
- 12.5 Applications of BN
- 12.6 Oxidation states of nitrogen
- 12.7 Nitrogen fixation
- 12.8 Environmental Significance of Nitrogen Species
- 12.9 Summary
- 12.10 Question
- 12.11 Reference and Suggested readings

---

### 12.0 Objectives

---

At the end of the unit learner will be able to

- Familiar with N-group.
- Learn the Nitrogen fixation.
- Understand about Oxidation states of nitrogen.
- Increase knowledge about nitrogen activation.
- Familiar with boron nitride compounds.

---

## 12.1 Introduction

---

Chapter deals with increasing the knowledge of learner for nitrogen family and its compound, their synthesis, reactions and structure. Chapter also explains brief about nitrogen compounds with is a matter of recent research. Along with these chapter also highlights the Nitrogen fixation.

---

## 12.2 Nitrogen group

---

Elements that are included in the Nitrogen family are: Nitrogen (N), Phosphorus (P), Arsenic (As), Antimony (Sb), and Bismuth (Bi). All Group 15 elements have the electron configuration of  $ns_2np_3$  in their outer shell where n is equal to the principal quantum number. The Nitrogen Family is located in the p-block of Group 15, as shown below.

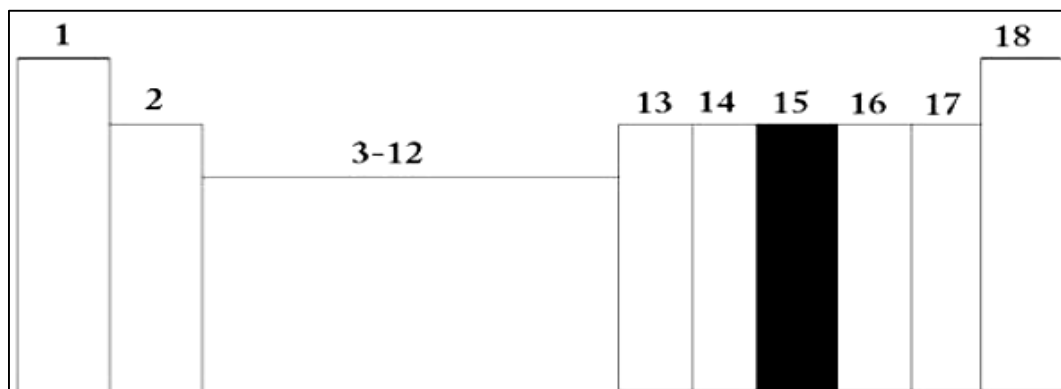

All Group 15 Elements tend to follow the general periodic trends:

Properties of Group 15 Elements							
Element/Symbol	Atomic Number	Mass	Electron Configuration	Covalent Radius (pm)	Electronegativity	First Ionization Energy (kJ/mol)	Common Physical Form(s)
Nitrogen (N)	7	14.01	$1s^2 2s^2 2p^3$	75	3.0	1402	Colorless Gas
Phosphorus (P)	15	30.97	$[\text{Ne}]3s^2 3p^3$	110	2.1	1012	White Solid / Red Solid
Arsenic (As)	33	74.92	$[\text{Ar}] 3d^{10} 4s^2 4p^3$	121	2.0	947	Yellow Solid / Gray Solid
Antimony (Sb)	51	121.76	$[\text{Kr}] 4d^{10} 5s^2 5p^3$	140	1.9	834	Yellow Solid / Silver-White Metallic Solid
Bismuth (Bi)	83	208.98	$[\text{Xe}] 4f^{14} 5d^{10} 6s^2 6p^3$	155	1.9	703	Pink-White Metallic Solid

- Electro negativity (the atom's ability of attracting electrons) increases up the group.
- Ionization Energy (the amount of energy required to remove an electron from the atom in its gaseous phase) increases up the group.
- Atomic Radii (the radius of the atom) increases down the group.
- Electron Affinity (ability of the atom to accept an electron) increases going up the group.
- Melting Point (amount of energy required to break bonds to change a solid phase substance to a liquid phase) increases going down the group.
- Boiling Point (amount of energy required to break bonds to change a liquid phase substance to a gas) increases going down the group.
- Metallic Character (how metallic the atom is) increases going down the group.

## **Nitrogen**

Nitrogen was discovered in 1770 by Scheele and Priestley. This non-metallic element has no color, taste or odor and is present in nature as a noncombustible gas. When compared with the rest of Group 15, Nitrogen has the highest electronegativity which illustrates it is the most non-metallic of the group. The common oxidation states of Nitrogen are +5, +3 and -3. Nitrogen makes up about 0.002% of the Earth's crust, however it constitutes 78% of the volume in Earth's atmosphere. Nitrogen has also been discovered in the atmosphere's of Venus and Mars. Venus has a 3.5% Nitrogen volume in its atmosphere and Mars contains 2.7% Nitrogen volume in its atmosphere. Natural sources of nitrogen can be found in animal/plant proteins and in fossilized remains of ancient plant life. Important nitrogen-containing minerals are niter,  $\text{KNO}_3$  and sodiumnitrite  $\text{NaNO}_3$  which are found in desert regions and are important in fertilizers. Before the process of converting Nitrogen into Ammonia was discovered, sources of Nitrogen were limited.

One of the processes of converting Nitrogen to Ammonia is the Haber-Bosch process. This process is therefore very important for the production of nitrogen.

Nitrogen has very little solubility in liquids.  $N_2$  does not have any allotropes. The unusually stable  $N_2(g)$  nitrogen gas is the source in which all nitrogen compounds are ultimately derived.  $N_2(g)$  is stable due to its electronic structure, the bond between the two Nitrogen atoms of  $N_2$  is a triple covalent bond which is strong and hard to break. The enthalpy change associated with breaking the bonds in  $N_2$  is highly endothermic  $N_2(g) \rightarrow 2N(g)$   $H = +945.4$  kJ. Nitrogen gas is used as a refrigerant, metal treatment, and pressurized gas for oil recovery. Additionally, the Gibbs energy of Nitrogen compounds are also not spontaneous and do not occur at normal temperatures.  $1/2N_2(g) + 1/2O_2 \rightarrow NO(g)$   $G_f = +86.55$ kJ. The oxides and oxyacids of nitrogen are nitrous oxide ( $N_2O$ ), nitrogen oxide (NO), and nitrogen dioxide ( $NO_2$ ). Nitrous oxide is “laughing gas” used in dental work, child birth and to increase the speed of cars. Nitrogen oxide is found in smog and neurotransmitters. Hydrazine,  $N_2H_4$  is a poisonous, colorless liquid that likes to explode in air; it is a good reducing agent, therefore, methyl hydrazine is used as a rocket fuel.

---

## 12.3 Nitrogen activation

---

### The Chemistry of Nitrogen

The chemistry of nitrogen is dominated by the ease with which nitrogen atoms form double and triple bonds. A neutral nitrogen atom contains five valence electrons:  $2s^2 2p^3$ . A nitrogen atom can therefore achieve an octet of valence electrons by sharing three pairs of electrons with another nitrogen atom.



Because the covalent radius of a nitrogen atom is relatively small (only 0.070 nm), nitrogen atoms come close enough together to form very strong bonds. The bond-dissociation enthalpy for the nitrogen-nitrogen triple bond is 946 kJ/mol, almost twice as large as that for an O=O double bond.

The strength of the nitrogen-nitrogen triple bond makes the  $N_2$  molecule very unreactive.  $N_2$  is so inert that lithium is one of the few elements with which it reacts at room temperature.

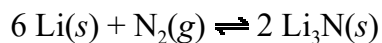

In spite of the fact that the  $\text{N}_2$  molecule is unreactive, compounds containing nitrogen exist for virtually every element in the periodic table except those in Group VIIIA (He, Ne, Ar, and so on). This can be explained in two ways. First,  $\text{N}_2$  becomes significantly more reactive as the temperature increases. At high temperatures, nitrogen reacts with hydrogen to form ammonia and with oxygen to form nitrogen oxide.

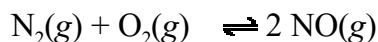
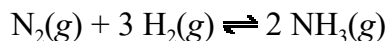

Second, a number of catalysts found in nature overcome the inertness of  $\text{N}_2$  at low temperature.

### **The Synthesis of Ammonia**

It is difficult to imagine a living system that does not contain nitrogen, which is an essential component of the proteins, nucleic acids, vitamins, and hormones that make life possible. Animals pick up the nitrogen they need from the plants or other animals in their diet. Plants have to pick up their nitrogen from the soil, or absorb it as  $\text{N}_2$  from the atmosphere. The concentration of nitrogen in the soil is fairly small, so the process by which plants reduce  $\text{N}_2$  to  $\text{NH}_3$  — or "fix"  $\text{N}_2$  — is extremely important.

Although 200 million tons of  $\text{NH}_3$  are produced by nitrogen fixation each year, plants, by themselves, cannot reduce  $\text{N}_2$  to  $\text{NH}_3$ . This reaction is carried out by blue-green algae and bacteria that are associated with certain plants. The best-understood example of nitrogen fixation involves the rhizobium bacteria found in the root nodules of legumes such as clover, peas and beans. These bacteria contain a nitrogenase enzyme, which is capable of the remarkable feat of reducing  $\text{N}_2$  from the atmosphere to  $\text{NH}_3$  at room temperature.

Ammonia is made on an industrial scale by a process first developed between 1909 and 1913 by Fritz Haber. In the **Haber process**, a mixture of N<sub>2</sub> and H<sub>2</sub> gas at 200 to 300 atm and 400 to 600°C is passed over a catalyst of finely divided iron metal.

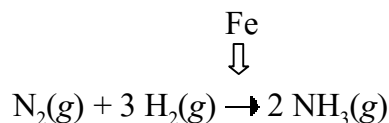

Almost 20 million tons of NH<sub>3</sub> are produced in the United States each year by this process. About 80% of it, worth more than \$2 billion, is used to make fertilizers for plants that can't fix nitrogen from the atmosphere. On the basis of weight, ammonia is the second most important industrial chemical in the United States. (Only sulfuric acid is produced in larger quantities.)

Two-thirds of the ammonia used for fertilizers is converted into solids such as ammonium nitrate, NH<sub>4</sub>NO<sub>3</sub>; ammonium phosphate, (NH<sub>4</sub>)<sub>3</sub>PO<sub>4</sub>; ammonium sulfate, (NH<sub>4</sub>)<sub>2</sub>SO<sub>4</sub>; and urea, H<sub>2</sub>NCONH<sub>2</sub>. The other third is applied directly to the soil as **anhydrous** (literally, "without water") ammonia. Ammonia is a gas at room temperature. It can be handled as a liquid when dissolved in water to form an aqueous solution. Alternatively, it can be cooled to temperatures below -33°C, in which case the gas condenses to form the anhydrous liquid, NH<sub>3</sub>(l).

### The Synthesis of Nitric Acid

The NH<sub>3</sub> produced by the Haber process that is not used as fertilizer is burned in oxygen to generate nitrogen oxide.

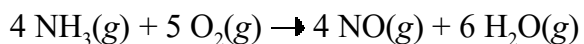

Nitrogen oxide — or nitric oxide, as it was once known — is a colorless gas that reacts rapidly with oxygen to produce nitrogen dioxide, a dark brown gas.

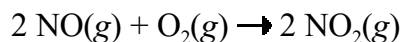

Nitrogen dioxide dissolves in water to give nitric acid and NO, which can be captured and recycled.

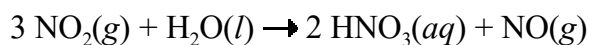

Thus, by a three-step process developed by Friedrich Ostwald in 1908, ammonia can be converted into nitric acid.

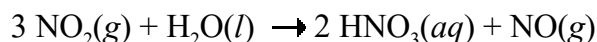
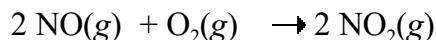

The Haber process for the synthesis of ammonia combined with the **Ostwald process** for the conversion of ammonia into nitric acid revolutionized the explosives industry. Nitrates have been important explosives ever since Friar Roger Bacon mixed sulfur, saltpeter, and powdered carbon to make gunpowder in 1245.

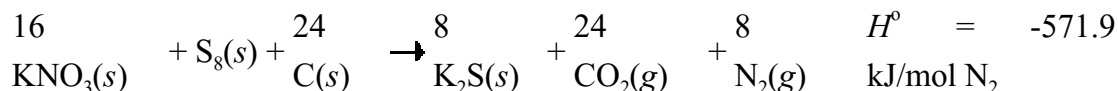

Before the Ostwald process was developed the only source of nitrates for use in explosives was naturally occurring minerals such as saltpeter, which is a mixture of  $\text{NaNO}_3$  and  $\text{KNO}_3$ . Once a dependable supply of nitric acid became available from the Ostwald process, a number of nitrates could be made for use as explosives. Combining  $\text{NH}_3$  from the Haber process with  $\text{HNO}_3$  from the Ostwald process, for example, gives ammonium nitrate, which is both an excellent fertilizer and a cheap, dependable explosive commonly used in blasting powder.



The destructive power of ammonia nitrate is apparent in photographs of the Alfred P. Murrah Federal Building in Oklahoma City, which was destroyed with a bomb made from ammonium nitrate on April 19, 1995.

## Intermediate Oxidation Numbers

Nitric acid ( $\text{HNO}_3$ ) and ammonia ( $\text{NH}_3$ ) represent the maximum (+5) and minimum (-3) oxidation numbers for nitrogen. Nitrogen also forms compounds with every oxidation number between these extremes (see table below).

### *Common Oxidation Numbers for Nitrogen*

<i>Oxidation Number</i>	<i>Examples</i>
-3	$\text{NH}_3, \text{NH}_4^+, \text{NH}_2^-, \text{Mg}_3\text{N}_2$
-2	$\text{N}_2\text{H}_4$
-1	$\text{NH}_2\text{OH}$
-1/3	$\text{NaN}_3, \text{HN}_3$
0	$\text{N}_2$
+1	$\text{N}_2\text{O}$
+2	$\text{NO}, \text{N}_2\text{O}_2$
+3	$\text{HNO}_2, \text{NO}_2^-, \text{N}_2\text{O}_3, \text{NO}^+$
+4	$\text{NO}_2, \text{N}_2\text{O}_4$
+5	$\text{HNO}_3, \text{NO}_3^-, \text{N}_2\text{O}_5$

---

## 12.4 Boron nitride

---

Boron nitride is a chemical compound with chemical formula BN, consisting of equal numbers of boron and nitrogen atoms. BN is isoelectronic to a similarly structured carbon lattice and thus exists in various crystalline forms.



The hexagonal form corresponding to graphite is the most stable and softest among BN polymorphs, and is therefore used as a lubricant and an additive to cosmetic products. The cubic (sphalerite structure) variety analogous to diamond is called c-BN. Its hardness is inferior only to diamond, but its thermal and chemical stability is superior. The rare wurtzite BN modification is similar to lonsdaleite and may even be harder than the cubic form. Boron nitride is rarely found in nature, as dispersed micrometer-sized inclusions of qingsongite (c-BN) in chromium-rich rocks in Tibet. It is therefore produced synthetically from boric acid or boron trioxide. The initial product is amorphous BN powder, which is converted to crystalline h-BN by heating in nitrogen flow at temperatures above 1500 °C.

C-BN is made by annealing h-BN powder at higher temperatures, under pressures above 5 GPa. Contrary to diamond, larger c-BN pellets can be produced by fusing (sintering) relatively cheap c-BN powders. As a result, c-BN is widely used in mechanical applications. Because of excellent thermal and chemical stability, boron nitride ceramics are traditionally used as parts of high-temperature equipment. Boron nitride has a great potential in nanotechnology.

Structure: Boron nitride has been produced in an amorphous (a-BN) and crystalline forms. The most stable crystalline form is the hexagonal one, also called h-BN,  $\alpha$ -BN, or g-BN (graphitic BN). It has a layered structure similar to graphite. Within each layer, boron and nitrogen atoms are bound by strong covalent bonds. The atoms are eclipsed, with boron atoms lying over and above nitrogen atoms. This registry reflects the polarity of the B-N bonds.

### **Synthesis:-**

#### **Preparation and reactivity of hexagonal BN**

Boron nitride has not been found in nature and therefore is produced synthetically. Hexagonal boron nitride is obtained by the reacting boron trioxide ( $B_2O_3$ ) or boric acid ( $B(OH)_3$ ) with ammonia ( $NH_3$ ) or urea ( $CO(NH_2)_2$ ) in a nitrogen atmosphere:<sup>[23]</sup>



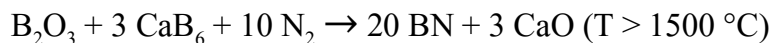
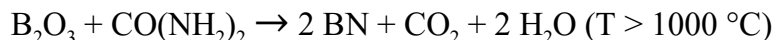
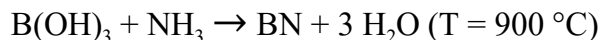

The resulting disordered (**amorphous**) boron nitride contains 92–95% BN and 5–8%  $\text{B}_2\text{O}_3$ . The remaining  $\text{B}_2\text{O}_3$  can be evaporated in a second step at temperatures  $> 1500 \text{ }^\circ\text{C}$  in order to achieve BN concentration  $>98\%$ .

### **Preparation of cubic BN**

Cubic boron nitride is produced by treating hexagonal boron nitride at high pressure and temperature, much as **synthetic diamond** is produced from graphite. Direct conversion of hexagonal boron nitride to the cubic form has been observed at pressures between 5 and 18 GPa and temperatures between 1730 and 3230  $^\circ\text{C}$ . The shock wave method is used to produce material called **heterodiamond**, a superhard compound of boron, carbon, and nitrogen.

### **Preparation of wurtzite BN**

Wurtzite BN can be obtained via static high-pressure or dynamic shock methods. The limits of its stability are not well defined. Both c-BN and w-BN are formed by compressing h-BN, but formation of w-BN occurs at much lower temperatures close to 1700  $^\circ\text{C}$ .

---

## **12.5 Applications of BN**

---

### **Hexagonal BN**

Hexagonal BN is the most widely used polymorph. It is a good lubricant at both low and high temperatures. Therefore, h-BN lubricants can be used even in vacuum, e.g. in space applications. The lubricating properties of fine-grained h-BN are used in **cosmetics**, **paints**, **dental cements**, and **pencil** leads.

currently h-BN is used by nearly all leading producers of cosmetic products for **foundations**, **make-up**, **eye shadows**, blushers, **kohl pencils**, **lipsticks** and other skincare products. Due to its excellent dielectric and thermal properties, BN is used

in electronics e.g. as a substrate for semiconductors, microwave-transparent windows, and as a structural material for seals

### **Cubic boron nitride**

Cubic boron nitride (CBN or c-BN) is widely used as an [abrasive](#). Materials with cubic boron nitride crystals are often used in the [tool bits](#) of [cutting tools](#). For grinding applications, softer binders, e.g. resin, porous ceramics, and soft metals, are used.

### **Amorphous boron nitride**

Layers of amorphous boron nitride (a-BN) are used in some [semiconductor devices](#), e.g. [MISFETs](#). They can be prepared by chemical decomposition of [trichloroborazine](#) with [caesium](#)

---

## **12.6 Oxidation states of nitrogen & their inter conversion**

---

**Nitrogen's oxidation states** Nitrogen forms compounds with a wide range of oxidation states that range from -3 for the nitride ion to +5 in nitrates and nitric acid. An example of each of these oxidation states are given in the table. While N<sub>2</sub> has a notoriously strong triple bond, its single bond is one of the weakest in all of chemistry. Compared to its neighbor carbon, in which the C-C single bond strength is 347 kJ/mol, the N-N single bond strength is only 160 kJ/mol. The effect of this is that nitrogen is unlikely to catenate like carbon.

**Uses.** Nitrogen is obtained from the fractional distillation of air. Air contains 78% nitrogen. As shown in the left figure below, about half of the nitrogen “produced” is used directly as nitrogen and about half is converted into ammonia.

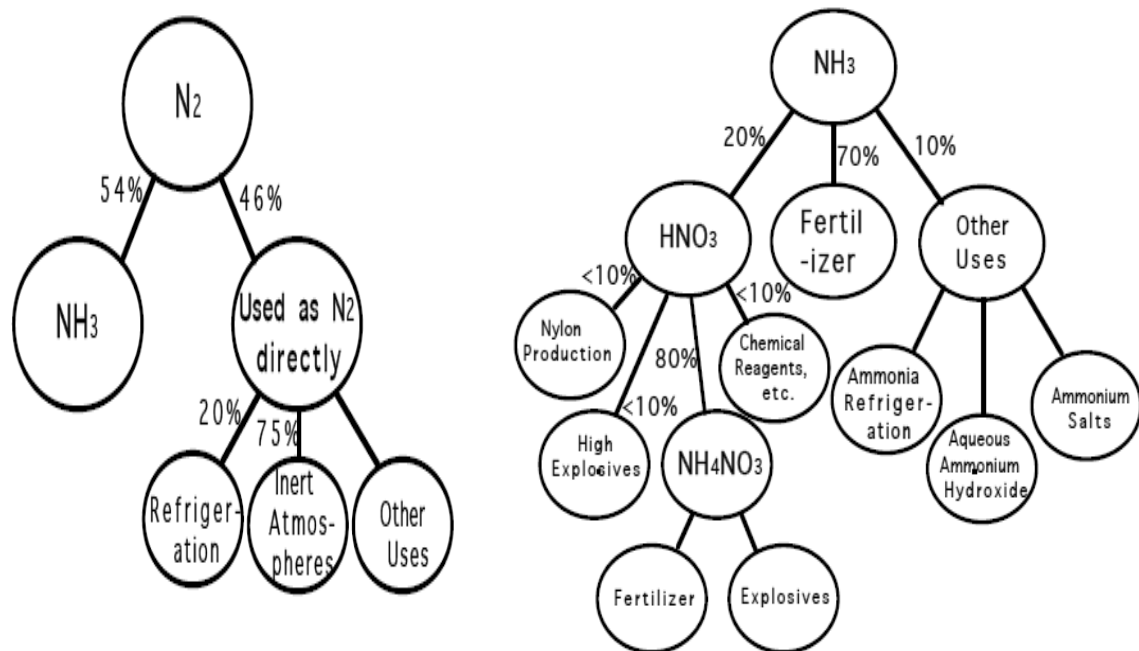

The main use of nitrogen gas is as an inert blanket in iron and steel industry as well as in related metallurgical and chemical activities where an inert atmosphere is required. Another important, large-scale use of nitrogen blankets is in the glass industry. Plate glass is floated over molten tin in order to make nearly perfectly smooth surface. The molten tin would rapidly oxidize if it were not for the blanket of nitrogen present. Nitrogen blankets are also employed in the electronics industry during construction of computer chips, transistors, diodes, etc.

A large amount of gaseous nitrogen is used as a purge gas in the petrochemical industry. Reactors and equipment are purged of oxygen and petroleum vapors before they are serviced in order to prevent explosions and fires. Approximately 10% of all  $N_2$  produced is used as a refrigerant in the form of liquid nitrogen. Rubbery or sticky substances cannot be machined or ground unless they are first frozen. Freeze grinding is also used to make hamburger. Because most materials shrink when cooled, liquid nitrogen is used in shrink fitting and assembly operations. Liquid nitrogen is used to quick freeze foods and to maintain refrigeration of frozen foods as they are transported over the highway. For

example, McDonalds transports its hamburgers frozen in liquid nitrogen to their destinations.

---

## 12.7 Nitrogen fixation

---

**Nitrogen fixation** is a process by which nitrogen ( $N_2$ ) in the atmosphere is converted into ammonium ( $NH_4$ ). Atmospheric nitrogen or molecular nitrogen ( $N_2$ ) is relatively inert: it does not easily react with other chemicals to form new compounds. The fixation process frees up the nitrogen atoms from their diatomic form ( $N_2$ ) to be used in other ways. Nitrogen fixation, natural and synthetic, is essential for all forms of life because nitrogen is required to biosynthesize basic building blocks of plants, animals and other life forms, e.g., nucleotides for DNA and RNA and amino acids for proteins. Therefore nitrogen fixation is essential for agriculture and the manufacture of fertilizer. It is also an important process in the manufacture of explosives (e.g. gunpowder, dynamite, TNT, etc.). Nitrogen fixation occurs naturally in the air by means of lightning. Nitrogen fixation also refers to other biological conversions of nitrogen, such as its conversion to nitrogen dioxide. Microorganisms that can fix nitrogen are prokaryotes (both bacteria and archaea, distributed throughout their respective kingdoms) called diazotrophs. Some higher plants, and some animals (termites), have formed associations (symbiosis) with diazotrophs.

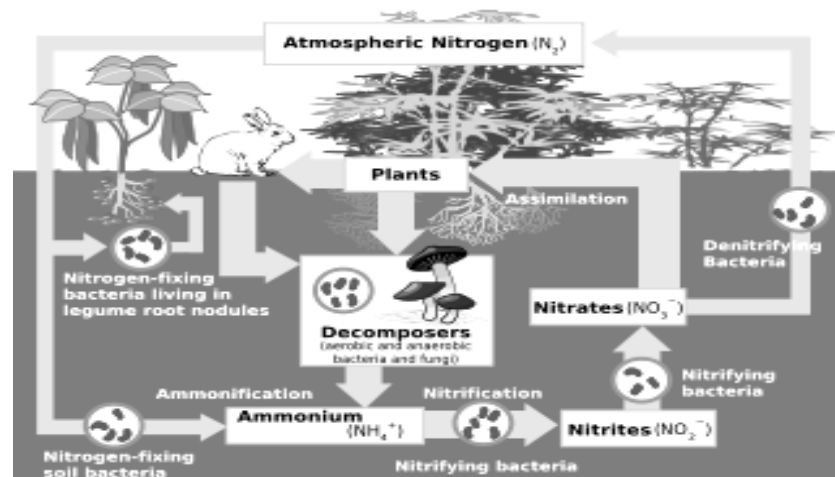

## Biological nitrogen fixation

Biological nitrogen fixation was discovered by the German agronomist Hermann Hellriegel and Dutch microbiologist Martinus Beijerinck. Biological nitrogen fixation (**BNF**) occurs when atmospheric nitrogen is converted to ammonia by an enzyme called nitrogenase. The reaction for BNF is:

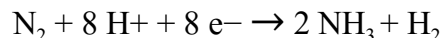

The process is coupled to the hydrolysis of 16 equivalents of ATP and is accompanied by the co-formation of one molecule of H<sub>2</sub>. In free-living diazotrophs, the nitrogenase-generated ammonium is assimilated into glutamate through the glutamine synthetase/glutamate synthase pathway. The microbial genes required for nitrogen fixation are widely distributed in diverse environments. Enzymes responsible for nitrogenase action are very susceptible to destruction by oxygen. Many bacteria cease production of the enzyme in the presence of oxygen. Many nitrogen-fixing organisms exist only in anaerobic conditions, respiring to draw down oxygen levels, or binding the oxygen with a protein such as hemoglobin.

## Microorganisms that fix nitrogen

Diazotrophs are cyanobacteria, e.g. the highly significant *trichodesmium*, green sulfur bacteria, azotobacteraceae, rhizobia and Frankia. Cyanobacteria inhabit nearly all illuminated environments on Earth and play key roles in the carbon and nitrogen cycle of the biosphere. In general, cyanobacteria are able to utilize a variety of inorganic and organic sources of combined nitrogen, like nitrate, nitrite, ammonium, urea, or some amino acids. Several cyanobacterial strains are also capable of diazotrophic growth, an ability that may have been present in their last common ancestor in the Archaean. Nitrogen fixation by cyanobacteria in coral reefs can fix twice the amount of nitrogen than on land—around 1.8 kg of nitrogen is fixed per hectare per day. The colonial marine cyanobacterium *Trichodesmium* is thought to fix nitrogen on such a scale that it accounts for almost half of the nitrogen-fixation in marine systems on a global scale.

### **Root nodule symbiosis (Legume family)**

Plants that contribute to nitrogen fixation include the legume family – Fabaceae – with taxa such as kudzu, clovers, soybeans, alfalfa, lupines, peanuts, and rooibos. They contain symbiotic bacteria called *Rhizobia* within nodules in their root systems, producing nitrogen compounds that help the plant to grow and compete with other plants. When the plant dies, the fixed nitrogen is released, making it available to other plants and this helps to fertilize the soil. The great majority of legumes have this association, but a few genera (e.g., *Styphnolobium*) do not. In many traditional and organic farming practices, fields are rotated through various types of crops, which usually includes one consisting mainly or entirely of clover or buckwheat (non-legume family *Polygonaceae*), which are often referred to as "green manure". Inga alley farming relies on the leguminous genus *Inga*, a small tropical, tough-leaved, nitrogen-fixing tree.

### **Industrial nitrogen fixation**

The possibility that atmospheric nitrogen reacts with certain chemicals was first observed by Desfosses in 1828. He observed that mixtures of alkali metal oxides and carbon react at high temperatures with nitrogen. With the use of barium carbonate as starting material the first commercially used process became available in the 1860s developed by Margueritte and Sourdeval. The resulting barium cyanide could be reacted with steam yielding ammonia. In 1898 Adolph Frank and Nikodem Caro decoupled the process and first produced calcium carbide and in a subsequent step reacted it with nitrogen to calcium cyanamide. The Ostwald process for the production of nitric acid was discovered in 1902. Frank-Caro process and Ostwald process dominated the industrial fixation of nitrogen until the discovery of the Haber process in 1909.

Artificial fertilizer production is now the largest source of human-produced fixed nitrogen in the Earth's ecosystem. Ammonia is a required precursor to fertilizers, explosives, and other products. The most common method is the Haber process. The Haber process requires high pressures (around 200 atm) and high temperatures (at least 400 °C), routine conditions for industrial catalysis. This highly efficient process uses natural gas as a hydrogen source and air as a nitrogen source. Much

research has been conducted on the discovery of catalysts for nitrogen fixation, often with the goal of reducing the energy required for this conversion. However, such research has thus far failed to even approach the efficiency and ease of the Haber process. Many compounds react with atmospheric nitrogen to give dinitrogen complexes. The first dinitrogen complex to be reported was based on ruthenium,  $[\text{Ru}(\text{NH}_3)_5(\text{N}_2)]_2^+$ .

---

## 12.8 Environmental Significance of Nitrogen Species

---

While nitrogen is seen to be an essential component of all living things, excessive concentrations of certain nitrogen species in some compartments of the environment can lead to significant environmental problems. This is true of some nitrogen species in the atmosphere as well as in terrestrial and aquatic environments.

### Atmospheric Concerns with Nitrogen Species

The three major environmental problems associated with nitrogen species in the atmosphere are photochemical smog, global warming, and stratospheric ozone depletion. Photochemical smog results when partially oxidized organic matter,  $\text{NO}_x$ , and sunlight come together under certain meteorological conditions, resulting in a series of complex chemical and photochemical reactions that lead to the production of high ozone concentrations and organic chemicals that together produce eye irritation, reduced air visibility, crop damage, and severe adverse health impacts in humans. The automobile has been a primary producer of two of the ingredients of photochemical smog, partially oxidized organic matter and  $\text{NO}_x$ . The most serious problems occur in dense urban areas where there are many automobiles.

Wide use of fossil fuels over the past century has resulted in an increase in atmospheric carbon dioxide, which acts as a blanket to prevent heat from radiating from the earth, a phenomenon, come to be known as the greenhouse effect, that is increasing the earth's temperature. However, the gaseous oxides of nitrogen also exhibit a greenhouse effect. While carbon dioxide is believed responsible for about 55 percent of the increased changes to the radiative temperature between 1980 and



1990, increased NO<sub>x</sub> production from fuel and biomass combustion and particularly from denitrification (N<sub>2</sub>O) as a result of increased commercial fertilizer usage is estimated to be responsible for 6 percent of the increase.<sup>1</sup> While the amount of NO<sub>x</sub> in the atmosphere would appear to be small compared with CO<sub>2</sub>, one molecule of N<sub>2</sub>O has a heat-trapping ability equivalent to 200 molecules of CO<sub>2</sub>. While NO<sub>x</sub> is partially responsible for increased ozone production as part of photochemical smog production in urban areas near the earth's surface, it is somewhat surprising that it also plays a role in the destruction of ozone in the stratosphere. Stratospheric ozone plays a key role in protecting life on earth from the harmful effects of excessive ultraviolet radiation. The widespread use of chlorofluorocarbons (CFCs) is known to have resulted in significant destruction of the protective stratospheric ozone, but NO<sub>x</sub> is playing a role as well. N<sub>2</sub>O and NO<sub>2</sub> are both converted to NO in the atmosphere, and NO reaching the stratosphere reacts with ozone to result in its depletion.

---

## **12.9 Summary**

---

This Chapter increases the knowledge of Nitrogen Group & Nitrogen activation and as well as this Chapter also explains brief about Nitrogen fixation and Environmental Significance of Nitrogen Species. In addition, Synthesis of Boron nitride Preparation and reactivity of BN and Oxidation states of nitrogen & their inter conversion.

---

## **12.10 Review Question**

---

1. Define Nitrogen fixation?
2. What is Boron nitride?
3. What are Environmental Significance of Nitrogen Species explain?
4. Define the Nitrogen activation?
5. Explain Synthesis of Boron nitride Preparation and reactivity of BN?

---

## 12.11 Reference and Suggested readings

---

1. Skoog, D. A., D. M. West, and F. J. Holler, "Fundamentals of Analytical Chemistry," 7<sup>th</sup> ed., Saunders College Pubs., Fort Worth, TX, 1996.
2. Skoog, D. A., F. J. Holler, and T. A. Nieman: "Principles of Instrumental Analysis," 5th ed., Saunders College Pubs, Philadelphia, 1998.

---

# Unit -13 : Oxygen Group

---

## Structure of Unit

- 13.0 Objectives
- 13.1 Introduction
- 13.2 Oxygen Group
- 13.3 Metal Selenide:
- 13.4 Metal Tellurides:
- 13.5 Oxyacids:
- 13.6 Oxyanion:
- 13.7 Ring, Cage and Cluster compounds of P- block elements:
- 13.8 Silicates:
- 13.9 Zeolite:
- 13.10 Summary
- 13.11 Review Question
- 13.12 References and Suggested Readings

---

## 13.0 Objectives

---

This chapter deals with the sixteen group of the periodic table i. e. oxygen group. This chapter deals with the general introduction and properties of the oxygen group, metal selenides, metal tellurides, oxyacides, oxyanion, silicates and zeolites.

---

## 13.1 Introduction

---

Group sixteen is the oxygen family. It consists of the elements oxygen, sulfur, selenium, tellurium, and polonium. Oxygen and sulfur are common elements. In fact, oxygen is the most common element (by mass) in the earth's crust. Because oxygen is second in electronegativity only to fluorine, it reacts with almost everything to form compounds here on earth. Selenium has some semimetal

characteristics, such as an increase in electrical conductivity when a light is shined on it. Tellurium is a true semimetal, existing in compound with both positive and negative charges. Polonium is an extremely rare radioactive element discovered by Marie Curie and named for her native Poland. This means that the oxygen family is split between nonmetals and semimetals.

---

## 13.2 Oxygen Group

---

oxygen group elements, also called chalcogen, any of the six chemical elements making up Group 16 (VIA) of the periodic classification namely, oxygen (O), sulfur (S), selenium (Se), tellurium (Te), polonium (Po), and livermorium (Lv).

S. No.	Element	Symbol	Electronic configuration
1.	Oxygen	O	[He]2s <sup>2</sup> 2p <sup>4</sup>
2.	Sulfur	S	[Ne]3s <sup>2</sup> 3p <sup>4</sup>
3.	Selenium	Se	[Ar]3d <sup>10</sup> 4s <sup>2</sup> 4p <sup>4</sup>
4.	Tellurium	Te	[Kr]4d <sup>10</sup> 5s <sup>2</sup> 5p <sup>4</sup>
5.	Polonium	Po	[Xe]4f <sup>14</sup> 5d <sup>10</sup> 6s <sup>2</sup> 6p <sup>4</sup>

The first element of this Group, oxygen, is the only gas, and is colourless and odourless. Sulfur is a pale yellow, brittle solid. Selenium can have either an amorphous or a crystalline structure; the amorphous form can be red or black, and the crystalline form can be red or grey. Tellurium is a silvery-white colour with a metallic lustre. Polonium is a naturally radioactive element.

### General Reactivity

Oxygen and sulfur are highly electronegative elements - the electronegativity of oxygen is second only to that of fluorine. Their general reactivity is therefore dominated by their ability to gain electrons.

There is a transition down the Group from non-metallic to more metallic properties, so that oxygen is a non-metal and tellurium a metalloid. All the elements except polonium form  $M^{2-}$  ions.

There is a marked difference between oxygen and the other members of the Group. This arises from

- (a) the small size of the O atom which enables it to form double bonds
- (b) its inability to expand its valence shell like the other elements as it has no accessible d-orbitals
- (c) its high electronegativity, which enables it to participate in hydrogen-bonding.

### **Occurrence and Extraction**

Oxygen occurs widely as the free element in the form of  $O_2$ , comprising 21% of the air by volume. It also occurs as  $O_3$ , ozone, at high altitudes in the ozone layer. In the combined form it is found in very many minerals, and also in water. Oxygen is obtained industrially by the fractional distillation of liquid air. It is stored under pressure in cylinders.

Sulfur is found as the free element and also as metal sulfide ores and a number of sulfates. Native sulfur is brought to the surface from underground deposits by the Frasch Process, which uses superheated water to melt the sulfur and force it upwards.

### **Physical Properties**

The covalent and ionic radii increase going down the Group, as electrons occupy shells with higher quantum numbers.

Oxygen occurs as two gaseous allotropes,  $O_2$  (dioxygen or more commonly oxygen) and  $O_3$  (trioxygen or ozone). Oxygen is the more common. It condenses to a pale blue paramagnetic liquid at  $-183^\circ\text{C}$ . Ozone is a pale blue, pungent gas which condenses to an inky-blue liquid at  $-112^\circ\text{C}$ . The ozone layer in the upper atmosphere is an important shield against harmful ultra-violet radiation from the sun.

Sulfur has several allotropes, the two main ones being rhombic and monoclinic sulfur. These both consist of S<sub>8</sub> molecules.

### Oxidation States and Electron Affinities

The oxidation number of oxygen in its compounds is almost always -2. The oxidation numbers of sulfur range from -2 to +6, but the most common are -2, +4 and +6. This wide range is partly due to sulfur's ability to accommodate extra electrons in its valence shell by using available d-orbitals.

The first electron affinity (electron gain) is exothermic, but the second is strongly endothermic and so overall the formation of O<sup>2-</sup> is endothermic. This is usually compensated by a high lattice enthalpy. Remember that electron affinities are quoted as -E kJ mol<sup>-1</sup>.

### Ionisation Energies/kJ mol<sup>-1</sup>

S. No.	Element	Symbol	Ionization energy/kJ mol <sup>-1</sup>			
			1 <sup>st</sup>	2 <sup>nd</sup>	3 <sup>rd</sup>	4 <sup>th</sup>
1.	Oxygen	O	1313.9	3388.2	5300.3	7469.1
2.	Sulfur	S	999.6	2251	3361	4564
3.	Selenium	Se	940.9	2044	2974	4144
4.	Tellurium	Te	869.2	1795	2698	3610

### 13.3 Metal Selenide:

A selenide is a chemical compound in which selenium serves as an anion with oxidation number of -2 (Se<sup>2-</sup>), much as sulfur does in a sulfide. The chemistry of the selenides and sulfides are similar. Similar to sulfide, for an aqueous solution, selenide ion, Se<sup>2-</sup>, is prevalent only in very basic conditions. In neutral conditions, hydroselenide ion, HSe<sup>-</sup>, is most common. In acid conditions, hydrogen selenide, H<sub>2</sub>Se, is formed.

Some selenides are reactive to oxidation by air. Owing to the greater reducing power of selenide, metal selenides are more easily decomposed to the elements than are sulfides (tellurides are even more labile). Selenides of electropositive metals: such as aluminium selenide readily hydrolyse, even in moist air, evolving toxic hydrogen selenide gas.

### **Polyselenides:**

Polyselenide anions are chains with the composition  $\text{Se}_n^{2-}$ . Polyselenides also refer to salts of these anions. They are commonly synthesized by melting elements together in a quartz tube. Selenium and an alkali metal react to initially give white, sparingly soluble solids like monoselenides. Excess selenium leads to the formation of soluble diselenides and very soluble polyselenides with even greater amounts of selenium. Alternatively, they can be prepared by dissolving selenium and an alkali metal in a liquid ammonia. Synthesis can also be conducted in high-boiling, polar, aprotic solvents such as DMF, HMPA, and NMP. Aqueous polyselenides undergo salt metathesis with large organic counterions to form crystalline salts that are soluble in organic solvents.

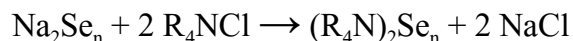

Polyselenides are prone to decomposition on exposure to air, in which case they are oxidized back to elemental selenium.

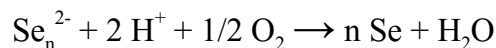

Polyselenides form metal complexes.  $\text{Se}_x$  ( $x=4,5,6$ ) function as chelating ligands complexes, e.g.  $(\text{C}_5\text{H}_5)_2\text{TiSe}_5$ , which is analogous to titanocene pentasulfide. Polyselenide anions reacts with organic halides:

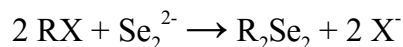

### **Cadmium Selenide:**

Cadmium selenide is an inorganic compound with the formula CdSe. It is a yellow-orange solid that is classified as a II-VI semiconductor of the n-type. Three crystalline forms of CdSe are known: wurtzite (hexagonal), sphalerite (cubic) and

rock-salt (cubic). The sphalerite CdSe structure is unstable and converts to the wurtzite form upon moderate heating. The transition starts at about 130°C, and at 700°C it completes within a day. The rock-salt structure is only observed under high pressure. The production of cadmium selenide has been carried out in two different ways. The preparation of bulk crystalline CdSe is done by the High-Pressure Vertical Bridgman method or High-Pressure Vertical Zone Melting

Cadmium selenide may also be produced in the form of nanoparticles. (see applications for explanation) Several methods for the production of CdSe nanoparticles have been developed: arrested precipitation in solution, synthesis in structured media, high temperature pyrolysis, sonochemical, and radiolytic methods are just a few.

Production of cadmium selenide by arrested precipitation in solution is performed by introducing alkylcadmium and trioctylphosphine selenide (TOPSe) precursors into a heated solvent under controlled conditions.

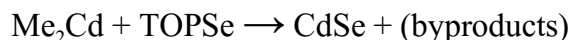

CdSe nanoparticles can be modified by production of two phase materials with ZnS coatings. The surfaces can be further modified, e.g. with mercaptoacetic acid, to confer solubility.

Synthesis in structured environments refers to the production of cadmium selenide in liquid crystal or surfactant solutions. The addition of surfactants to solutions often results in a phase change in the solution leading to a liquid crystallinity. A liquid crystal is similar to a solid crystal in that the solution has long range translational order. Examples of this ordering are layered alternating sheets of solution and surfactant, micelles, or even a hexagonal arrangement of rods. Application and safety information

CdSe material is transparent to infra-red (IR) light and has seen limited use photoresistors and in windows for instruments utilizing IR light. The material is also highly luminescent. Cadmium is a toxic heavy metal and appropriate precautions should be taken when handling it and its compounds. Selenides are toxic in large amounts. Cadmium selenide is a known carcinogen to humans and



medical attention should be sought if swallowed or if contact with skin or eyes occurs.

### **Zinc selenide:**

Zinc selenide (ZnSe), is a light yellow solid compound. It is an intrinsic semiconductor with a band gap of about 2.70 eV at 25°C. ZnSe rarely occurs in nature. It is found in the mineral stilleite named after Hans Stille.

ZnSe can be made in both hexagonal (wurtzite) and cubic (zincblende) crystal structure.

It is a wide-bandgap semiconductor of the II-VI semiconductor group (since zinc and selenium belong to the 12th and 16th groups of the periodic table, respectively). The material can be doped n-type doping with, for instance, halogen elements. P-type doping is more difficult, but can be achieved by introducing nitrogen.

### **Applications:**

ZnSe is used to form II-VI light-emitting diodes and diode lasers. It emits blue light. ZnSe doped with chromium (ZnSe:Cr) has been used as an infrared laser gain medium emitting at about 2.4  $\mu\text{m}$ .

It is used as an infrared optical material with a remarkably wide transmission wavelength range (0.45  $\mu\text{m}$  to 21.5  $\mu\text{m}$ ). The refractive index is about 2.67 at 550 nm (green), and about 2.40 at 10.6  $\mu\text{m}$ . Similar to zinc sulfide, ZnSe is produced as microcrystalline sheets by synthesis from hydrogen selenide gas and zinc vapour. When especially free of absorption and inclusions it can be used particularly for CO<sub>2</sub> laser optics at 10.6  $\mu\text{m}$  wavelength. It is thus a very important IR material. In daily life, it can be found as the entrance optic in the new range of "in-ear" clinical thermometers and can be just seen as a small yellow window. Zinc selenide can slowly react with atmospheric moisture if poorly polished, but this is not generally a serious problem. Except where optics are used in spectroscopy or at the Brewster angle, antireflection or beamsplitting optical coatings are generally employed.

ZnSe activated with tellurium (ZnSe(Te)) is a scintillator with emission peak at 640 nm, suitable for matching with photodiodes. It is used in x-ray and gamma ray detectors. ZnSe scintillators are significantly different from the ZnS ones. Mercury selenide:

Mercury selenide (HgSe) is a chemical compound of mercury and selenium. It is a grey-black crystalline solid semi-metal with a sphalerite structure. The lattice constant is 0.608 nm. Mercury selenide can also refer to the following chemical compounds: HgSe<sub>2</sub> and HgSe<sub>8</sub>. HgSe is strictly mercury(II) selenide.

HgSe occurs naturally as the mineral Tiemannite.

#### **Applications:**

Selenium is used in filters in some steel plants to remove mercury from exhaust gases. The solid product formed is HgSe.

HgSe can be used as an ohmic contact to wide-gap II-VI semiconductors such as zinc selenide or zinc oxide.

#### **Toxicity:**

HgSe is non-toxic so long as it is not ingested due to its insolubility. Toxic hydrogen selenide fumes can be evolved on exposure to acids. HgSe is a relatively stable compound which might mean that it is less toxic than elemental mercury or many organometallic mercury compounds. Selenium's ability to complex with mercury has been proposed as a reason for the lack of mercury toxicity in deep sea fish despite high mercury levels.

#### **Sodium Selenide:**

Sodium selenide is an inorganic compound of sodium and selenium with the chemical formula Na<sub>2</sub>Se. This colourless solid is prepared by the reaction of selenium with a solution of sodium in ammonia. Like other alkali metal chalcogenides, this material is highly sensitive to water, easily undergoing hydrolysis to give mixtures of sodium biselenide (NaSeH) and hydroxide. This hydrolysis occurs because of the extreme basicity of the Se<sup>2-</sup> ion.

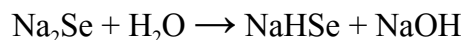

Similarly, sodium selenide is readily oxidized to polyselenides, a conversion signaled by off-white samples.

Sodium selenide reacts with acids to produce toxic hydrogen selenide gas.

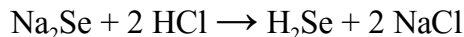

The compound reacts with electrophiles to produce the selenium compounds. With alkyl halides, one obtains a variety of organoselenium compounds:

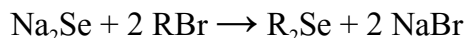

Organotin and organosilicon halides react similarly to give the expected derivatives:

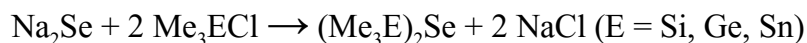

---

### 13.4 Metal Tellurides:

---

The telluride ion is the term for the anion  $\text{Te}^{2-}$  and its derivatives. Telluride is member of the series of dianions  $\text{O}^{2-}$ ,  $\text{S}^{2-}$ , and  $\text{Se}^{2-}$ . Many metal tellurides are known, including some telluride minerals. Although the bonding in such materials is often fairly covalent, they are described casually as salts of  $\text{Te}^{2-}$ . Using this approach,  $\text{Ag}_2\text{Te}$  is derived from  $\text{Ag}^+$ .

The minerals include natural gold tellurides, like calaverite and krennerite ( $\text{AuTe}_2$ ), and sylvanite ( $\text{AgAuTe}_4$ ). Commercially, the tellurides are minor ores of gold, although they comprise the major naturally-occurring compounds of gold. (A few other natural compounds of gold, such as the bismuthide maldonite ( $\text{Au}_2\text{Bi}$ ) and antimonide aurostibite ( $\text{AuSb}_2$ ), are known).

Tellurides of economic importance for their physical properties are those of cadmium, bismuth, and lead. Cadmium telluride has photovoltaic activity. Bismuth telluride and lead telluride are exceptional thermoelectric materials.

#### Hydrogen tellurides:

Hydrogen telluride (tellurane) is the inorganic compound with the formula  $\text{H}_2\text{Te}$ . The simplest hydride of tellurium, it is rarely encountered because it decomposes rapidly to the constituent elements. However, the gas can exist at very low

concentrations long enough to be readily detected by the odour of rotting garlic or rotting leeks. Most compounds with Te-H bonds (tellurols) are unstable with respect to loss of H<sub>2</sub>. H<sub>2</sub>Te is chemically and structurally similar to hydrogen selenide, both are acidic. The H-Te-H angle is about 90°. Volatile tellurium compounds often have unpleasant odours, reminiscent of decayed leeks or garlic.

### **Synthesis:**

H<sub>2</sub>Te is prepared by the acidification of salts of Te<sup>2-</sup>, such as Al<sub>2</sub>Te<sub>3</sub> and Na<sub>2</sub>Te. Na<sub>2</sub>Te can be generated by the reaction of Na and Te in anhydrous ammonia. The intermediate in the acidification is a stable anion. Sodium hydrogen telluride, NaHTe, can be made by reducing tellurium with NaBH<sub>4</sub>

### **Preparation:**

Tellurium hydrides is usually prepared in the laboratory by hydrolysis of the telluride derivatives of electropositive metals. Typical is the hydrolysis of aluminum telluride:

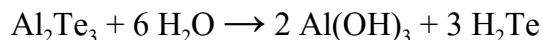

Magnesium and alkali metal tellurides can also be hydrolyzed. Usually these procedures require acid since the H<sub>2</sub>Te is rather acidic. Electrolytic methods have been developed.

### **Properties:**

H<sub>2</sub>Te is an endothermic compound, unstable in air and easily oxidised to water and elemental tellurium:

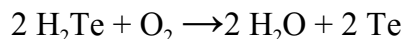

It is almost as acidic as phosphoric acid ( $K_a = 8.1 \times 10^{-3}$ ), having a  $K_a$  value of about  $2.3 \times 10^{-3}$ . It reacts with many metals to form tellurides.

### **Sodium telluride:**

**Sodium telluride** is the chemical compound with the formula Na<sub>2</sub>Te. This salt is the conjugate base of the thermally unstable acid hydrogen telluride, but it is usually prepared by reduction of tellurium with sodium. Na<sub>2</sub>Te is a challenging

material to handle because it is very sensitive to air. Air oxidizes it initially to polytellurides, which have the formula  $\text{Na}_2\text{Te}_x$  ( $x > 1$ ), and ultimately Te metal. Samples of  $\text{Na}_2\text{Te}$ , which are colourless when absolutely pure, generally appear purple or gray due to the effects of air oxidation

### **Synthesis, structure and solution properties:**

The synthesis is typically conducted using ammonia as the solvent.  $\text{Na}_2\text{Te}$ , like many related compounds with the formula  $\text{M}_2\text{X}$ , adopts the antifluorite structure. Thus, in solid  $\text{Na}_2\text{Te}$  each  $\text{Te}^{2-}$  ion is surrounded by eight  $\text{Na}^+$  ions and each  $\text{Na}^+$  ion is surrounded by four  $\text{Te}^{2-}$  ions.

Simple salts of the type  $\text{M}_2\text{X}$ , where X is a monatomic anion, are not typically soluble in any solvent because they have a high lattice energy. Upon addition of water - even moist air - or treatment with alcohols,  $\text{Te}^{2-}$  protonates:

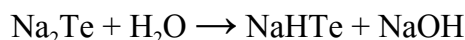

Because of this reaction, many processes attributed to  $\text{Na}_2\text{Te}$  may involve NaHTe, which is more soluble and formed readily

### **Application in organic chemistry:**

$\text{Na}_2\text{Te}$  finds use in organic synthesis, both as a reagent for reductions and as a source of Te in the synthesis of organotellurium compounds. Arylhalides are substituted to diaryl tellurides, as illustrated by the synthesis of dinaphthyltelluride:

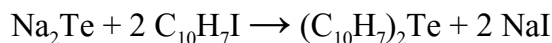

$\text{Na}_2\text{Te}$  reacts with 1,3-diyne to give the corresponding tellurophene, which are structurally analogous to thiophenes:



As a reducing agent,  $\text{Na}_2\text{Te}$  converts nitro groups to amines and will cleave certain C-X bonds.

---

## 13.5 Oxyacids:

---

oxyacid, any oxygen-containing acid. Most covalent nonmetallic oxides react with water to form acidic oxides; that is, they react with water to form oxyacids that yield hydronium ions ( $\text{H}_3\text{O}^+$ ) in solution. There are some exceptions, such as carbon monoxide, CO, nitrous oxide,  $\text{N}_2\text{O}$ , and nitric oxide, NO.

The strength of an oxyacid is defined by the extent to which it dissociates in water (i.e., its ability to form  $\text{H}^+$  ions). In general, the relative strength of oxyacids can be predicted on the basis of the electronegativity and oxidation number of the central nonmetal atom. The acid strength increases as the electronegativity of the central atom increases. For example, because the electronegativity of chlorine (Cl) is greater than that of sulfur (S), which is in turn greater than that of phosphorus (P), it can be predicted that perchloric acid,  $\text{HClO}_4$ , is a stronger acid than sulfuric acid,  $\text{H}_2\text{SO}_4$ , which should be a stronger acid than phosphoric acid,  $\text{H}_3\text{PO}_4$ . For a given nonmetal central atom, the acid strength increases as the oxidation number of the central atom increases. For example, nitric acid,  $\text{HNO}_3$ , in which the nitrogen (N) atom has an oxidation number of +5, is a stronger acid than nitrous acid,  $\text{HNO}_2$ , where the nitrogen oxidation state is +3. In the same manner, sulfuric acid,  $\text{H}_2\text{SO}_4$ , with sulfur in its +6 oxidation state, is a stronger acid than sulfurous acid,  $\text{H}_2\text{SO}_3$ , where a +4 oxidation number of sulfur exists.

The salt of an oxyacid is a compound formed when the acid reacts with a base:

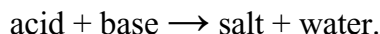

This type of reaction is called neutralization, because the solution is made neutral.

### Oxyacids of sulfur:

There are many oxyacids of sulfur. The most important of these acids are sulfuric acid,  $\text{H}_2\text{SO}_4$ , and sulfurous acid,  $\text{H}_2\text{SO}_3$ .

Sulfuric acid is sometimes referred to as the “king of chemicals” because it is produced worldwide in such large quantities. In fact, per capita use of sulfuric acid has been taken as one index of the technical development of a country. Annual

production in the United States, which is the world's leading producer, is well over 39 billion kg (86 billion pounds). It is the cheapest bulk acid.

Pure  $\text{H}_2\text{SO}_4$  undergoes extensive self-ionization (sometimes called autoprotolysis).



This autoprotolysis reaction is, however, only one of the equilibrium reactions that occur in pure  $\text{H}_2\text{SO}_4$  to give it an extremely high electrical conductivity. There are three additional equilibrium reactions that take place because of the ionic self-dehydration of sulfuric acid.

### **Oxyacids of nitrogen:**

Nitric acid,  $\text{HNO}_3$ , was known to the alchemists of the 8th century as “aqua fortis” (strong water). It is formed by the reaction of both dinitrogen pentoxide ( $\text{N}_2\text{O}_5$ ) and nitrogen dioxide ( $\text{NO}_2$ ) with water. Small amounts of nitric acid are found in the atmosphere after thunderstorms, and its salts, called nitrates, occur widely in nature. Enormous deposits of sodium nitrate,  $\text{NaNO}_3$ , also known as Chile saltpetre, are found in the desert region near the boundary of Chile and Peru. These deposits can be 3 km (2 miles) wide, 300 km (200 miles) long, and up to 2 metres (7 feet) thick. Potassium nitrate,  $\text{KNO}_3$ , sometimes called Bengal saltpetre, is found in India and other countries in East Asia. Nitric acid can be prepared in the laboratory by heating a nitrate salt, such as those mentioned above, with concentrated sulfuric acid; for example,

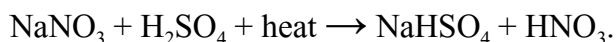

---

## **13.6 Oxyanion:**

---

An oxyanion or oxoanion is a chemical compound with the generic formula  $\text{A}_x\text{O}_y^{z-}$  (where A represents a chemical element and O represents an oxygen atom). Oxoanions are formed by a large majority of the chemical elements. The formulae of simple oxoanions are determined by the octet rule. The structures of condensed oxoanions can be rationalized in terms of  $\text{AO}_n$  polyhedral units with sharing of corners or edges between polyhedra. The phosphate and polyphosphate esters AMP, ADP and ATP are important in biology.

### Monomeric and poly oxoanions:

The formula of monomeric oxoanions,  $\text{AO}_n^{m-}$ , is dictated by the oxidation state of the element A and its position in the periodic table. Elements of the first row are limited to a maximum coordination number of 4. However, none of the first row elements has a monomeric oxoanion with that coordination number. Instead, carbonate ( $\text{CO}_3^{2-}$ ) and nitrate ( $\text{NO}_3^-$ ) have a trigonal planar structure with  $\pi$  bonding between the central atom and the oxygen atoms. This  $\pi$  bonding is favoured by the similarity in size of the central atom and oxygen.

A polyoxoanion is a polymeric oxoanion in which multiple oxoanion monomers, usually regarded as  $\text{MO}_n$  polyhedra, are joined by sharing corners or edges. When two corners of a polyhedron are shared the resulting structure may be a chain or a ring. Short chains occur, for example, in polyphosphates. Inosilicates, such as pyroxenes, have a long chain of  $\text{SiO}_4$  tetrahedra each sharing two corners. The same structure occurs in so-called meta-vanadates, such as ammonium metavanadate,  $\text{NH}_4\text{VO}_3$ .

### Acid base properties:

Most oxoanions are weak bases and can be protonated to give acids or acid salts. For example, the phosphate ion can be successively protonated to form phosphoric acid.

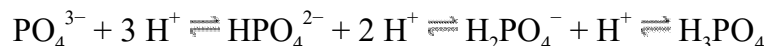

The extent of protonation in aqueous solution will depend on the acid dissociation constants and pH. For example, AMP (adenosine monophosphate) has a  $\text{p}K_a$  value of 6.21, so at pH 7 it will be about 10% protonated. Charge neutralization is an important factor in these protonation reactions. By contrast, the univalent anions perchlorate and permanganate ions are very difficult to protonate and so the corresponding acids are strong acids.

Although acids such as phosphoric acid are written as  $\text{H}_3\text{PO}_4$ , the protons are attached to oxygen atoms forming hydroxyl groups, so the formula can also be written as  $\text{OP}(\text{OH})_3$  to better reflect the structure. Sulfuric acid may be written as  $\text{O}_2\text{S}(\text{OH})_2$ ; this is the molecule observed in the gas phase.



The phosphite ion,  $\text{PO}_3^{3-}$ , is a strong base, and so always carries at least one proton. In this case the proton is attached directly to the phosphorus atom with the structure  $\text{HPO}_3^{2-}$ . In forming this ion, the phosphite ion is behaving as a Lewis base and donating a pair of electrons to the Lewis acid,  $\text{H}^+$ .

---

### 13.7 Ring, Cage and Cluster compounds of P- block elements:

---

**Benzene** is an organic chemical compound with the molecular formula  $\text{C}_6\text{H}_6$ . Its molecule is composed of 6 carbon atoms joined in a ring, with 1 hydrogen atom attached to each carbon atom. Because its molecules contain only carbon and hydrogen atoms, benzene is classed as a hydrocarbon.

**Pyridine** is a basic heterocyclic organic compound with the chemical formula  $\text{C}_5\text{H}_5\text{N}$ . It is structurally related to benzene, with one methylene ( $=\text{CH}-$ ) replaced by a nitrogen atom. The pyridine ring occurs in many important compounds, including azines and the vitamins niacin and pyridoxal

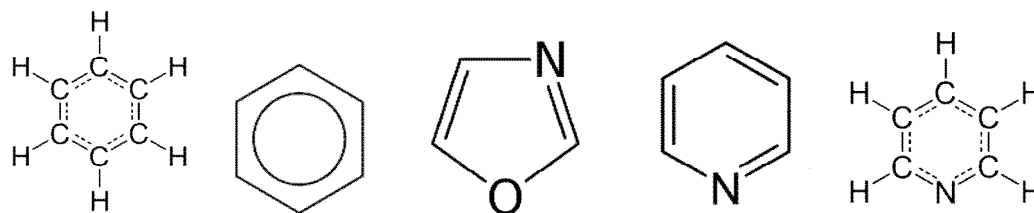

**Ring compounds benzene (a, b), oxazole (c) and pyridine (d, e)**

**Oxazole** is the parent compound for a vast class of heterocyclic aromatic organic compounds. These are azoles with an oxygen and a nitrogen separated by one carbon. Oxazoles are aromatic compounds but less so than the thiazoles. Oxazole is a weak base; its conjugate acid has a  $\text{pK}_a$  of 0.8, compared to 7 for imidazole.

A fullerene is any molecule composed entirely of carbon, in the form of a hollow sphere, ellipsoid, tube, and many other shapes. Spherical fullerenes are also called buckyballs, and they resemble the balls used in football (soccer). Cylindrical ones are called carbon nanotubes or buckytubes. Fullerenes are similar in structure to graphite, which is composed of stacked graphene sheets of linked hexagonal rings; but they may also contain pentagonal (or sometimes heptagonal) rings.

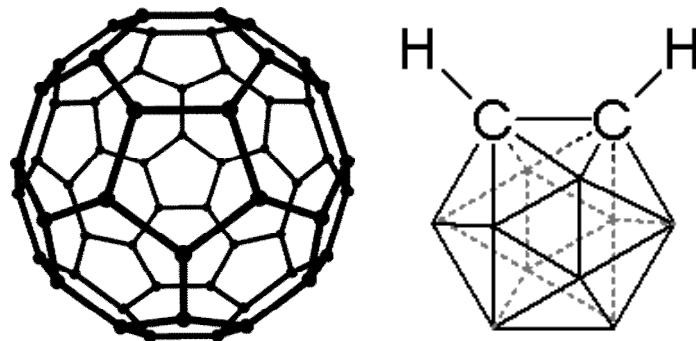

A carborane is a cluster composed of boron, carbon and hydrogen atoms. Like many of the related boranes, these clusters are polyhedra and are similarly classified as *closo-*, *nido-*, *arachno-*, *hypho-*, etc. based on whether they represent a complete (*closo-*) polyhedron, or a polyhedron that is missing one (*nido-*), two (*arachno-*), or more vertices.

The most heavily studied carborane is  $C_2B_{10}H_{12}$ , m. p. 320 °C. It is often prepared from the reaction of acetylene with decaborane. A variation on this method entails the use of dimethyl acetylenedicarboxylate to give  $C_2B_{10}H_{10}(CO_2C H_3)_2$ , which can be degraded to the  $C_2B_{10}H_{12}$ .

---

### 13.8 Silicates:

---

A silicate is a compound containing an anionic silicon compound. The great majority of silicates are oxides, but hexafluorosilicate ( $[SiF_6]^{2-}$ ) and other anions are also included. This article focuses mainly on the Si-O anions. Silicates comprise the majority of Earth's crust, as well as the other terrestrial planets, rocky moons, and asteroids. Sand, Portland cement, and thousands of minerals are examples of silicates. "Orthosilicate" is the anion  $SiO_4^{4-}$  or its compounds. Related to orthosilicate are families of anions (and their compounds) with the formula  $[SiO_{2+n}]^{2n-}$ . Important members are the cyclic and single chain silicates  $\{[SiO_3]^{2-}\}_n$  and the sheet-forming silicates  $\{[SiO_{2.5}]\}_n$ .

Silicate compounds, including the minerals, consist of silicate anions whose charge is balanced by various cations. Myriad silicate anions can exist, and each can form compounds with many different cations. Hence this class of compounds is very large. Both minerals and synthetic materials fit in this class.

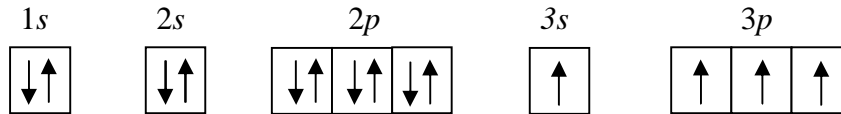

Electronic configuration of silicon atom in excited state.

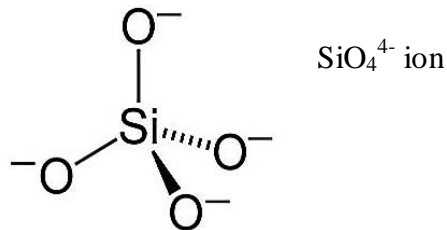

### Classification of silicates:

Since  $\text{Si}^{+4}$  is a highly charged cation, Pauling's rules state that it should be separated as far as possible from other  $\text{Si}^{+4}$  ions. Thus, when these  $\text{SiO}_4^{4-}$  tetrahedrons are linked together, only corner oxygens will be shared with other  $\text{SiO}_4^{4-}$  groups. Several possibilities exist and give rise to the different silicate groups.

#### Nesosilicates (Island Silicates)

If the corner oxygens are not shared with other  $\text{SiO}_4^{4-}$  tetrahedrons, each tetrahedron will be isolated. Thus, this group is often referred to as the island silicate group. The basic structural unit is then  $\text{SiO}_4^{4-}$ . In this group the oxygens are shared with octahedral groups that contain other cations like  $\text{Mg}^{+2}$ ,  $\text{Fe}^{+2}$ , or  $\text{Ca}^{+2}$ . Olivine is a good example:  $(\text{Mg,Fe})_2\text{SiO}_4$ .

#### Sorosilicates (Double Island Silicates)

If one of the corner oxygens is shared with another tetrahedron, this gives rise to the sorosilicate group. It is often referred to as the double island group because there are two linked tetrahedrons isolated from all other tetrahedrons. In this case, the basic structural unit is  $\text{Si}_2\text{O}_7^{6-}$ . A good example of a sorosilicate is the mineral

hemimorphite -  $Zn_4Si_2O_7(OH)H_2O$ . Some sorosilicates are a combination of single and double islands, like in epidote -  $Ca_2(Fe^{+3},Al)Al_2(SiO_4)(Si_2O_7)(OH)$ .

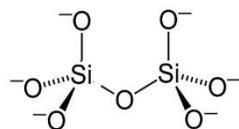

Structure of double island silicates

### Cyclosilicates (Ring Silicates)

If two of the oxygens are shared and the structure is arranged in a ring, such as that shown here, we get the basic structural unit of the cyclosilicates or ring silicates. Shown here is a six membered ring forming the structural group  $Si_6O_{18}^{-12}$ . Three membered rings,  $Si_3O_9^{-6}$ , four membered rings,  $Si_4O_{12}^{-8}$ , and five membered rings  $Si_5O_{15}^{-10}$  are also possible. A good example of a cyclosilicate is the mineral Beryl -  $Be_3Al_2Si_6O_{18}$ .

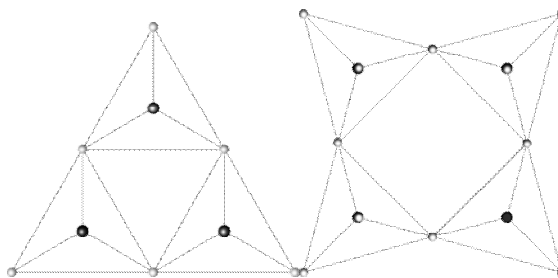

Structure of ring silicates

### Inosilicates (Single Chain Silicates)

If two of the oxygens are shared in a way to make long single chains of linked  $SiO_4$  tetrahedra, we get the single chain silicates or inosilicates. In this case the basic structural unit is  $Si_2O_6^{-4}$  or  $SiO_3^{-2}$ . This group is the basis for the pyroxene group of minerals, like the orthopyroxenes  $(Mg,Fe)SiO_3$  or the clinopyroxenes  $Ca(Mg,Fe)Si_2O_6$ .

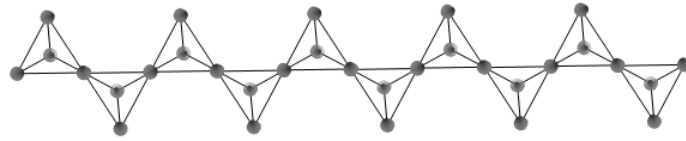

Structure of single chain silicates

### Inosilicates (Double Chain Silicates)

If two chains are linked together so that each tetrahedral group shares 3 of its oxygens, we can form double chains, with the basic structural group being  $\text{Si}_4\text{O}_{11}^-$ . The amphibole group of minerals are double chain silicates, for example the tremolite - ferroactinolite series -  $\text{Ca}_2(\text{Mg,Fe})_5\text{Si}_8\text{O}_{22}(\text{OH})_2$ .

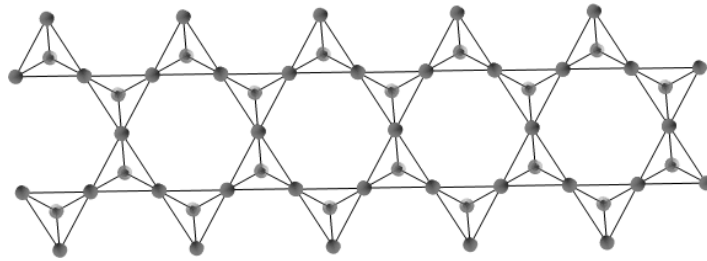

Structure of double chain silicates

### Phyllosilicates (Sheet Silicates)

If 3 of the oxygens from each tetrahedral group are shared such that an infinite sheet of  $\text{SiO}_4$  tetrahedra are shared we get the basis for the phyllosilicates or sheet silicates. In this case the basic structural group is  $\text{Si}_2\text{O}_5^{2-}$ . The micas, clay minerals, chlorite, talc, and serpentine minerals are all based on this structure. A good example is biotite -  $\text{K}(\text{Mg,Fe})_3(\text{AlSi}_3)\text{O}_{10}(\text{OH})_2$ . Note that in this structure, Al is substituting for Si in one of the tetrahedral groups.

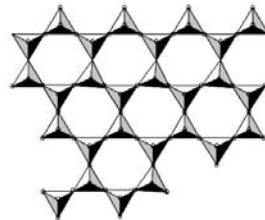

Structure of sheet silicates

### **Tectosilicates (Framework Silicates)**

If all of the corner oxygens are shared with another  $\text{SiO}_4$  tetrahedron, then a framework structure develops. The basic structural group then becomes  $\text{SiO}_2$ . The minerals quartz, cristobalite, and tridymite all are based on this structure. If some of the  $\text{Si}^{+4}$  ions are replaced by  $\text{Al}^{+3}$  then this produces a charge imbalance and allows for other ions to be found coordinated in different arrangements within the framework structure. Thus, the feldspar and feldspathoid minerals are also based on the tectosilicate framework.

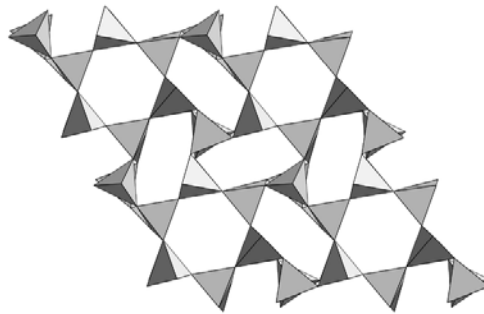

3D structure of framework silicates

### **Uses of silicate:**

#### **Microchips**

Unique properties of silicates include the ability to conduct electricity, produce a high-frequency vibration and provide thermal insulation. Silicon is the central component of silicates. It is a very hard crystal that can be cut to minuscule sizes, and it conducts electricity. It is because of these characteristics that silicon is the perfect material to make microchips, which run every computer, cell phone and gaming device.

Microchips are silicon cut down to micro proportions with governing instructions imprinted on them through photographic processes. Silicon's ability to conduct electricity powers the microchip to operate. The governing instructions tell the computer how to operate similarly to how the human brain tells the body to operate.

## **Quartz Crystals**

Quartz crystals are another silicate with a unique ability to produce a rhythmic high-frequency vibration. For this reason, these crystals are used to make oscillators used in watches, radios and pressure gages. The crystal emits a rhythmic beat that when hooked up to an electronic source and movement piece can be logged, generally as a megahertz (MHz), which is 1 million cycles per second. In the instance of a clock, the crystal's rhythmic beat moves the second hand. Quartz crystals are also used in mysticism.

## **Glass**

Silicates are also used to make glass and ceramics. To do so, hard, formless material like sand or ceramic clay is heated to high temperatures, turning it into malleable material that can be formed to make drinking glasses, for example, or when lead is added to the molten liquid--crystal glass.

## **Ceramics**

Silicate ceramics have clearly defined thermal properties and, as such, are particularly useful for advanced engineering and technology. For example, silicate ceramic tiles are used on the space shuttle to shield it from the extreme temperatures of the outer atmosphere.

## **High and Low Technology**

Silicates are the most abundant mineral class on Earth. In general, they are hard and cut easily to micro pieces, produce a rhythmic high-frequency vibration, and provide thermal insulation properties. These unique characteristics make them highly useful for myriad high- and low-tech products, from microchips to watches.

---

## **13.9 Zeolite**

---

Zeolites are microporous, aluminosilicate minerals commonly used as commercial adsorbents and catalysts. The term zeolite was originally coined in 1756 by Swedish mineralogist Axel Fredrik Cronstedt, who observed that upon rapidly heating the material stilbite, it produced large amounts of steam from water that had been adsorbed by the material.

Properties:

Zeolites have a porous structure that can accommodate a wide variety of cations, such as  $\text{Na}^+$ ,  $\text{K}^+$ ,  $\text{Ca}^{2+}$ ,  $\text{Mg}^{2+}$  and others. These positive ions are rather loosely held and can readily be exchanged for others in a contact solution. Some of the more common mineral zeolites are analcime, chabazite, clinoptilolite, heulandite, natrolite, phillipsite, and stilbite. An example mineral formula is:  $\text{Na}_2\text{Al}_2\text{Si}_3\text{O}_{10}\cdot 2\text{H}_2\text{O}$ , the formula for natrolite.

Natural zeolites form where volcanic rocks and ash layers react with alkaline groundwater. Zeolites also crystallize in post-depositional environments over periods ranging from thousands to millions of years in shallow marine basins. Naturally occurring zeolites are rarely pure and are contaminated to varying degrees by other minerals, metals, quartz, or other zeolites. For this reason, naturally occurring zeolites are excluded from many important commercial applications where uniformity and purity are essential.

#### **Natural occurrence**

Conventional open pit mining techniques are used to mine natural zeolites. The overburden is removed to allow access to the ore. The ore may be blasted or stripped for processing by using tractors equipped with ripper blades and front-end loaders. In processing, the ore is crushed, dried, and milled. The milled ore may be air-classified as to particle size and shipped in bags or bulk. The crushed product may be screened to remove fine material when a granular product is required, and some pelletized products are produced from fine material.

**Uses:**

#### **Commercial and domestic**

Zeolites are widely used as ion-exchange beds in domestic and commercial water purification, softening, and other applications. In chemistry, zeolites are used to separate molecules (only molecules of certain sizes and shapes can pass through), and as traps for molecules so they can be analyzed.



Zeolites have the potential of providing precise and specific separation of gases including the removal of H<sub>2</sub>O, CO<sub>2</sub> and SO<sub>2</sub> from low-grade natural gas streams. Other separations include noble gases, N<sub>2</sub>, O<sub>2</sub>, freon and formaldehyde.

### **Heating and refrigeration**

Zeolites can be used as solar thermal collectors and for adsorption refrigeration. In these applications, their high heat of adsorption and ability to hydrate and dehydrate while maintaining structural stability is exploited. This hygroscopic property coupled with an inherent exothermic (energy releasing) reaction when transitioning from a dehydrated to a hydrated form make natural zeolites useful in harvesting waste heat and solar heat energy. Zeolites are also used as a molecular sieve in cryosorption style vacuum pumps.

### **Agriculture**

In agriculture, clinoptilolite (a naturally occurring zeolite) is used as a soil treatment. It provides a source of slowly released potassium. If previously loaded with ammonium, the zeolite can serve a similar function in the slow release of nitrogen. Zeolites can also act as water moderators, in which they will absorb up to 55% of their weight in water and slowly release it under the plant's demand. This property can prevent root rot and moderate drought cycles.

---

## **13.10 Summary**

---

This chapter discussed with the sixteen group of the periodic table i. e. oxygen group. This chapter deals with the general introduction and properties of the oxygen group, metal selenides, metal tellurides, oxyacides, oxyanion, silicates and zeolites.

---

## **13.11 Glossary**

---

1. Allotropes: Allotropy or allotropism meaning is the property of some chemical elements to exist in two or more different forms, known as allotropes of these elements.
2. Electron affinity: the electron affinity of an atom or molecule is defined as the amount of energy released when an electron is added to a neutral atom or molecule in the gaseous state to form a negative ion.

3. Selenide: A selenide is a chemical compound in which selenium serves as an anion with oxidation number of  $-2$  ( $\text{Se}^{2-}$ ), much as sulfur does in a sulfide. The chemistry of the selenides and sulfides are similar.
4. Chelation: Chelation describes a particular way that ions and molecules bind metal ions. According to the International Union of Pure and Applied Chemistry (IUPAC), chelation involves the formation or presence of two or more separate coordinate bonds between a polydentate (multiple bonded) ligand and a single central atom.
5. Tellurides: The telluride ion is the term for the anion  $\text{Te}^{2-}$  and its derivatives. Telluride is member of the series of dianions  $\text{O}^{2-}$ ,  $\text{S}^{2-}$ , and  $\text{Se}^{2-}$ . Many metal tellurides are known, including some telluride minerals.
6. Oxyacids: oxyacid, any oxygen-containing acid. Most covalent nonmetallic oxides react with water to form acidic oxides; that is, they react with water to form oxyacids that yield hydronium ions ( $\text{H}_3\text{O}^+$ ) in solution.
7. Oxyanion: An oxyanion or oxoanion is a chemical compound with the generic formula  $\text{A}_x\text{O}_y^{z-}$  (where A represents a chemical element and O represents an oxygen atom).
8. Silicates: A silicate is a compound containing an anionic silicon compound. The great majority of silicates are oxides, but hexafluorosilicate ( $[\text{SiF}_6]^{2-}$ ) and other anions are also included.
9. Zeolite: Zeolites are microporous, aluminosilicate minerals commonly used as commercial adsorbents and catalysts.

---

### 13.12 Review Question

---

1. Discuss the physical properties of oxygen group.
2. Write detailed notes on metal selenides?
3. Write short note on zinc selenide.
4. What do you mean by metal tellurides?
6. What do you mean by oxyacids and oxyanions?
7. Discuss various types of silicates in details.

8. What are zeolites? Give the uses of zeolites.

---

### **13.13 References and Suggested Readings**

---

1. Concise Inorganic chemistry- J.D. Lee (Blackwell Science) 2001
2. Inorganic Chemistry- F.A. Cotton (Interscience publisher) 2008
3. Inorganic chemistry, principles of structure and reactivity- James E. Huheey (Harper Collins college publishers) 1993
4. Inorganic chemistry- G Sharpe, (Pearson printice hall) 2005
5. Inorganic chemistry- James E. House (Elsevier academic press) 2008
6. [en.wikipedia.org/](http://en.wikipedia.org/)

---

# Unit -14 : Halogen group

---

## Structure of Unit:

- 14.0 Objectives
  - 14.1 Introduction
  - 14.2 Halogen Family
  - 14.3 Halogen Elements
  - 14.4 Properties of Halogen Elements
  - 14.5 Halogen oxyacids and oxoanions
  - 14.6 Chemistry of interhalogen compounds
  - 14.7 Bonding in interhalogens
  - 14.8 Pseudohalogen
  - 14.9 Applications of Halogens
  - 14.10 Biological role of Halogen anions
  - 14.11 Toxicity of Halogen Elements
  - 14.12 Summary
  - 14.13 Review Question
  - 14.14 Reference and Suggested readings
- 

## 14.0 Objectives

---

At the end of the unit learner will be able to

- Familiar with Halogen group.
  - Learn the oxyacids & oxoanions of Hallogens Bonding.
  - Understand about Interhalogens.
  - Increase knowledge about Pseudohalogen.
  - Familiar with synthesis, properties & applications of Halogen.
- 

## 14.1 Introduction

---

Chapter deals with increasing the knowledge of learner for halogen family and its compound, their synthesis, reactions and structure. Chapter also explain brief about Pseudohalogen. Alongwith these chapter also highlights the oxyacids & oxoanions of Halogens Bonding..

---

## 14.2 Halogen Family

---

The halogens are located on the left of the noble gases on the periodic table. These five toxic, non-metallic elements make up Group 17 of the periodic table and consist of: fluorine (F), chlorine (Cl), bromine (Br), iodine (I), and astatine (At). Although astatine is radioactive and only has short-lived isotopes, it behaves similar to iodine and is often included in the halogen group. Because the halogen elements have seven valence electrons, they only require one additional electron to form a full octet. This characteristic makes them more reactive than other non-metal groups.

Halogens form diatomic molecules (of the form  $X_2$ , where X denotes a halogen atom) when they are in their pure states. The bonds in these diatomic molecules are non-polar covalent single bonds. However, halogens readily combine with most elements and are never seen uncombined in nature. As a general rule, fluorine is the most reactive halogen and astatine is the least reactive. All halogens form Group 1 salts with similar properties. In these compounds, halogens are present as halide anions with charge of -1 (e.g.  $Cl^-$ ,  $Br^-$ , etc.). Replacing the -ine ending with an -ide ending indicates the presence of halide anions; for example,  $Cl^-$  is named "chloride." In addition, halogens act as oxidizing agents—they exhibit the property to oxidize metals. Therefore, most of the chemical reactions that involve halogens are oxidation-reduction reactions in aqueous solution. The halogens often form single bonds, when in the -1 oxidation state, with carbon or nitrogen in organic compounds. When a halogen atom is substituted for a covalently bonded hydrogen atom in an organic compound, the prefix halo- can be used in a general sense, or the prefixes fluoro-, chloro-, bromo-, or iodo- can be used for specific halogen substitutions. Halogen elements can cross-link to form diatomic molecules with polar covalent single bonds. Chlorine ( $Cl_2$ ) was the first halogen to be discovered

in 1774, followed by iodine ( $I_2$ ), bromine ( $Br_2$ ), fluorine ( $F_2$ ), and astatine (At, discovered last in 1940). The name "halogen" is derived from the Greek roots hal- (which means "salt") and -gen (which means "to form"). Together these words combine to mean "salt former", referencing the fact that halogens form salts when they react with metals. Halite is the mineral name for rock salt, a natural mineral consisting essentially of sodium chloride ( $NaCl$ ). Lastly, the halogens are also relevant in daily life, whether it be the fluoride that goes in toothpaste, the chlorine that disinfects drinking water, or the iodine that facilitates the production of thyroid hormones in one's body.

---

### 14.3 Halogen Elements:

---

**Fluorine** - Fluorine has an atomic number of 9 and is denoted by the symbol F. Elemental fluorine was first discovered in 1886 by isolating it from hydrofluoric acid. Fluorine exists as a diatomic molecule in its free state ( $F_2$ ) and is the most abundant halogen found in the Earth's crust. Fluorine is the most electronegative element in the periodic table. It appears as a pale yellow gas at room temperature. Fluorine also has a relatively small atomic radius. Its oxidation state is always -1 except in its elemental, diatomic state (in which its oxidation state is zero). Fluorine is extremely reactive and reacts directly with all elements except helium (He), neon (Ne) and argon (Ar). In  $H_2O$  solution, hydrofluoric acid (HF) is a weak acid. Although fluorine is highly electronegative, its electronegativity does not determine its acidity; HF is a weak acid due to the fact that the fluoride ion is basic ( $pH > 7$ ). In addition, fluorine produces very powerful oxidants. For example, fluorine can react with the noble gas

xenon and form the strong oxidizing agent Xenon Difluoride ( $XeF_2$ ). There are many uses for fluorine, which will be discussed in Part VI of this article.

**Chlorine** - Chlorine has the atomic number 17 and the chemical symbol Cl. Chlorine was discovered in 1774 by extracting it from hydrochloric acid. In its elemental state, it forms the diatomic molecule  $Cl_2$ . Chlorine exhibits multiple oxidation states, such as -1, +1, 3, 5, and 7. At room temperature it appears as a light green gas. Since the bond that forms between the two chlorine atoms is weak,

the  $\text{Cl}_2$  molecule is very reactive. Chlorine reacts with metals to produce salts called chlorides. Chloride ions are the most abundant ions that dissolve in the ocean. Chlorine also has two isotopes:  $^{35}\text{Cl}$  and  $^{37}\text{Cl}$ . Sodium chloride is the most prevalent compound of the chlorides.

**Bromine** - Bromine has an atomic number of 35 with a symbol of Br. It was first discovered in 1826. In its elemental form, it is the diatomic molecule  $\text{Br}_2$ . At room temperature, bromine is a reddish-brown liquid. Its oxidation states vary from -1, +1, 3, 4 and 5. Bromine is more reactive than iodine, but not as reactive as chlorine. Also, bromine has two isotopes:  $^{79}\text{Br}$  and  $^{81}\text{Br}$ . Bromine consists of bromide salts, which have been found in the sea. The world production of bromide has increased significantly over the years, due to its access and longer existence. Like all of the other halogens, bromine is an oxidizing agent, and is very toxic.

**Iodine** - Iodine has the atomic number 53 and symbol I. Iodine has oxidation states -1, +1, 5 and 7. Iodine exists as a diatomic molecule,  $\text{I}_2$ , in its elemental state. At room temperature, it appears as a violet solid. Iodine has one stable isotope  $^{127}\text{I}$ . It was first discovered in 1811 through the use of seaweed and sulfuric acid. Currently, iodide ions can be isolated in seawater. Although iodine is not very soluble in water, the solubility may increase if particular iodides are mixed in the solution. Iodine has many important roles in life, including thyroid hormone production. This will be discussed in Part VI of the text.

**Astatine** - Astatine is a radioactive element with an atomic number of 85 and symbol At. Its possible oxidation states include: -1, +1, 3, 5 and 7. It is the only halogen that is not a diatomic molecule and it appears as a black, metallic solid at room temperature. Astatine is a very rare element, so there is not that much known about this element. In addition, astatine has a very short radioactive half-life, no longer than a couple of hours. It was discovered in 1940 by synthesis. Also, it is thought that astatine is similar to iodine. However, these two elements are assumed to differ by their metallic character.

---

## 14.4 Properties of Halogen Elements:

---

The periodic trends observed in the halogen group:

**(A) Melting and Boiling Points: increases down the group**

The melting and boiling points increase down the group because of the van der Waals forces. The size of the molecules increases down the group. This increase in size means an increase in the strength of the van der Waals forces.



**(B) Atomic Radius: increases down the group**

The size of the nucleus increases down a group (F < Cl < Br < I < At) because the numbers of protons and neutrons increase. In addition, more energy levels are added with each period. This results in a larger orbital, and therefore a longer atomic radius.

**(C) Ionization Energy: decreases down the group**

If the outer valence electrons are not near the nucleus, it does not take as much energy to remove them. Therefore, the energy required to pull off the outermost electron is not as high for the elements at the bottom of the group since there are more energy levels. Also, the high ionization energy makes the element appear non-metallic. Iodine and astatine display metallic properties, so ionization energy decreases down the group (At < I < Br < Cl < F).

**(D) Electronegativity: decreases down the group**

The number of valence electrons in an atom increases down the group due to the increase in energy levels at progressively lower levels. The electrons are progressively further from the nucleus; therefore, the nucleus and the electrons are not as attracted to each other. An increase in shielding is observed. Electronegativity therefore decreases down the group (At < I < Br < Cl < F).

**(E) Electron Affinity: decreases down the group**

Since the atomic size increases down the group, electron affinity generally decreases (At < I < Br < F < Cl). An electron will not be as attracted to the nucleus, resulting in a low electron affinity. However, fluorine has a lower electron affinity than chlorine. This can be explained by the small size of fluorine, compared to chlorine.



### (F) Reactivity of Elements: decreases down the group

The reactivities of the halogens decrease down the group (  $\text{At} < \text{I} < \text{Br} < \text{Cl} < \text{F}$ ). This is due to the fact that atomic radius increases in size with an increase of electronic energy levels. This lessens the attraction for valence electrons of other atoms, decreasing reactivity. This decrease also occurs because electronegativity decreases down a group; therefore, there is less electron "pulling." In addition, there is a decrease in oxidizing ability down the group.

## 14.5 Halogen oxyacids and oxoanions

The oxyacids and their conjugate salt anions, the oxoanions, of the halogens form the most complete series of any of the elements. Of course, they are only possible for chlorine, bromine and iodine, as fluorine is more electronegative than oxygen. Chlorine and iodine form almost identical series of these compounds, but bromine is more difficult to ionize to the highest oxidation state (7), another consequence of the scandide contraction. However, an important difference exists for the periodic acid, which has the formula  $\text{H}_5\text{IO}_6$ , which corresponds to the formula  $\text{HIO}_4 + 2 \text{H}_2\text{O}$ . However, periodate which exists in basic media is still  $\text{IO}_4^-$ .

There is a great deal to be learned from a careful study of the halogen oxyacids and their anions, especially the series shown in the diagram for chlorine. They are the most complete series of element-oxoanions known. Each is separated from the other by a change of two oxidation numbers for the central atom. The +7 state is highly reactive, and in particular

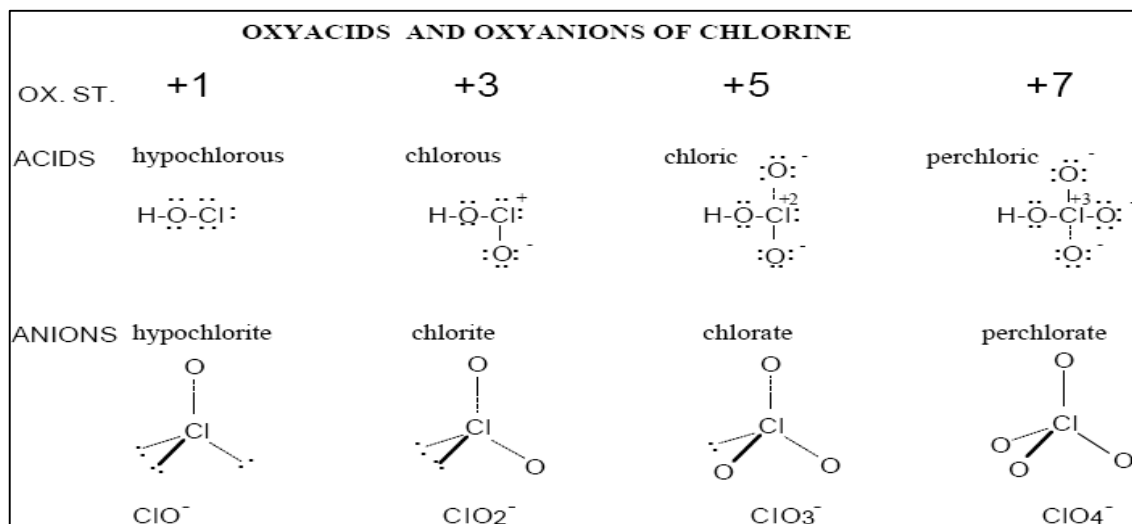

anhydrous (pure) perchloric acid as well as many perchlorate salts is strong oxidizers. The explosive hazard of perchlorates was discussed in Chemistry 2810. The interconversion of these oxy compounds was also discussed in Chemistry 2810 and rationalized using electrochemical data. There are also neutral oxygen compounds of chlorine involved in the redox cycles, including  $\text{Cl}_2\text{O}$  (a brown-yellow gas),  $\text{ClO}_2$  (a yellow gas) and  $\text{Cl}_2\text{O}_7$  (a colourless liquid). Those such as  $\text{ClO}_2$  that belong to even oxidation states of chlorine are odd-electron compounds (free radicals). This species is produced in dilute form on a large scale as an oxidant for the bleaching of paper pulp. It is produced by the reaction of sulfur dioxide on chlorate salts by the reaction:

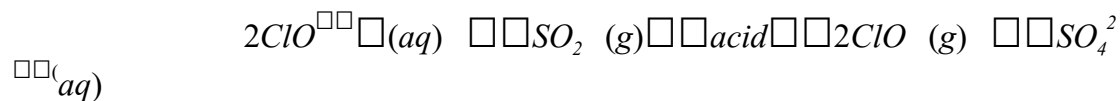

The diagram that follows summarizes the reactions involved in the interconversion of the halogen oxyacids. Many of the reactions are either disproportionation or comproportionation reactions.

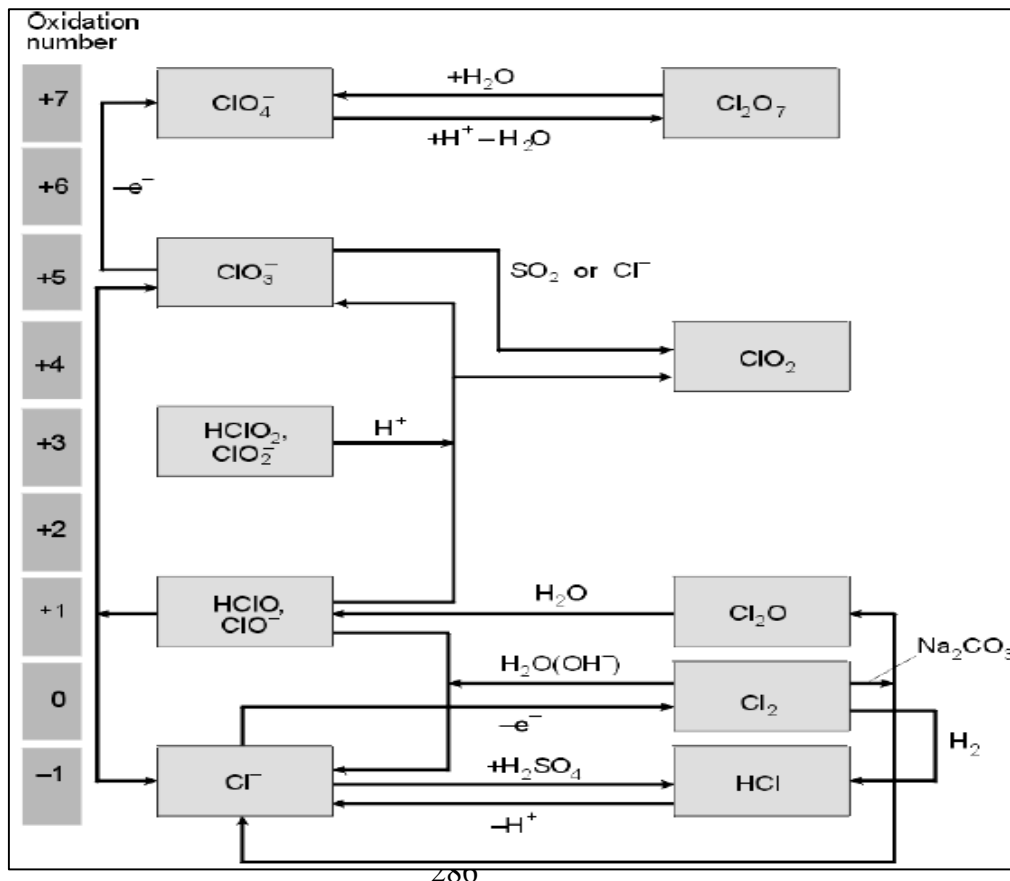

## 14.6 Chemistry of interhalogen compounds

The halogens form derivatives of almost all the elements. Indeed, fluorine combines with *all* elements except helium argon and neon. So common, and so important, are the element halides, that halogen derivatives are discussed for all the other elements. Hence we will not deal with them in this section. An important class of compounds exists, however, in which halogen elements are bonded to each other. Such compounds (which may be neutral, anionic or cationic) are known as **interhalogens**.

KNOWN INTERHALOGEN COMPOUNDS				
	Parent halogen	Cl	Br	I
STRUCTURES		ClF	BrF	IF
			BrCl	ICl IBr
		ClF <sub>3</sub>	BrF <sub>3</sub>	IF <sub>3</sub> I <sub>2</sub> Cl <sub>6</sub>
		ClF <sub>5</sub>	BrF <sub>5</sub>	IF <sub>5</sub> IF <sub>7</sub>

In the laboratory for Chemistry 3810 we deal with interhalogen compounds in experiment #10. Each of the three compounds in this laboratory are examples of monovalent iodine, but they are prepared as neutral (IBr), anionic ( $\text{ICl}_2^-$ ), as well as the cationic complex of  $\text{I}^+$  with pyridine ligands. These simple compounds serve to illustrate the fascinating chemical behaviour of the interhalogen compounds. The structures of the interhalogens are accurately given by the VSEPR theory as shown in the scheme at right, including a rare example of a pentagonal bipyramidal molecule in  $\text{IF}_7$ .

(Although the evidence is that this compound has a slightly irregular structure, with inequivalent bond lengths in the pentagonal plane.) All are based on simple

monomeric structures, with the heavier halogen as central atom, with the sole exception of "ICl<sub>3</sub>", which is actually a chlorine-bridged dimer, as follows:

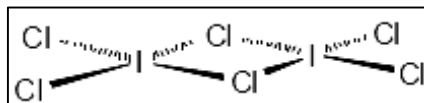

Those examples which are unstable compounds are enclosed in dashed boxes. They decompose by the following reactions

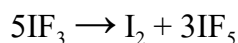
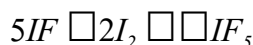

### Halogen and interhalogen anions

The simple anions are perhaps the most commonly encountered for all the halogen elements. Closely related to the halogen anions F<sup>-</sup>, Cl<sup>-</sup>, Br<sup>-</sup> and I<sup>-</sup> are the molecular ions known as the **pseudohalides**. These are an important class of mononegative anions that mimic the chemistry of the halides. In a few cases, the corresponding neutral dimers also exist, i.e. what is often called a **pseudohalogen**. Some common examples of this class of compounds are in the following table.

Pseudohalide	Pseudohalogen	$E_{1/2}^0(\text{red.})/V$	Acid	$pK_a^*$
CN <sup>-</sup> cyanide	NCCN cyanogen	+0.27	HCN hydrogen cyanide	9.2
SCN <sup>-</sup> thiocyanate	NCSSCN dithiocyanogen	+0.77	HCNS hydrogen isothiocyanate	-1.9
OCN <sup>-</sup> cyanate			HCNO isocyanic acid	3.5
CNO <sup>-</sup> fulminate			HCNO fulminic acid	
NNN <sup>-</sup> azide			HNNN hydrazoic acid	4.92

\* A. Alberta and E.R. Serjeant, The determination of ionization constants, London (1984).

The most common examples of an interhalogen anions is most definitely the triiodide ion,  $I_3^-$ . The tribromide ion is also known, but trichloride is much less stable and is rarely encountered.

### Halogen and interhalogen cations

Cations of halogens can form under strongly oxidizing conditions. For example, iodine is oxidized in fuming sulfuric acid to the blue paramagnetic diiodonium cation,  $I_2^+$ .

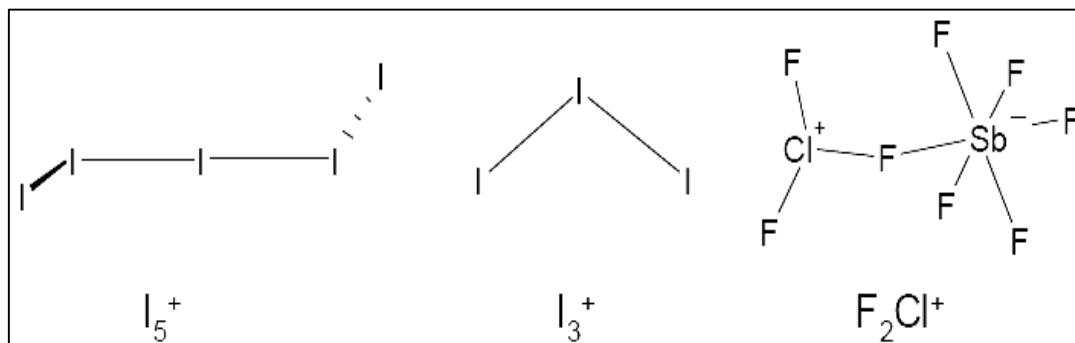
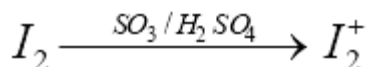

The last example is that of a mixed-halide cation, which is formed by the interaction of the powerful Lewis acid  $SbF_5$  with the corresponding neutral chlorine fluoride  $ClF_3$ . Chemistry of this type is dependent on the properties of a class of reagents known as **superacids**. Superacids are extremely strongly acidic, *non-aqueous* solutions of which fuming sulphuric acid was the original inspiration. A superacid normally contains a strong Brønsted acid as well as a powerful Lewis acid. In fuming sulfuric, the former is supplied by  $H_2SO_4$ , while  $SO_3$  functions as the latter.

---

## 14.7 Bonding in interhalogens

---

The bonding in electron-deficient compounds such as the boron hydrides. A general theme for such compounds is the tendency to form dimers or clusters which can be thought of as measures of desperation: if the elements cannot gain sufficient electrons they somehow have to make with what they have. The halogen

and noble gas compounds we are now considering are, however, examples of (extreme) electron richness. Remember that in the dihalogens themselves, there is only a single empty orbital capable of accepting electrons, the  $2s_u^*$  orbital. Yet halogens are noted charge acceptors, forming so-called charge transfer complexes with a wide variety of electron donors. This tendency can only be explained by the high electronegativity of the halogens, resulting in the fact that even the highest valence molecular orbital is relatively low lying in energy.

### (A) Bonding in ICl

As our first example of bonding in electron-rich halogens, consider the simple interhalogen compound ICl. The UV-PES of this interhalogen is shown at right, and a PM3 MO calculation results (partial) at the left.

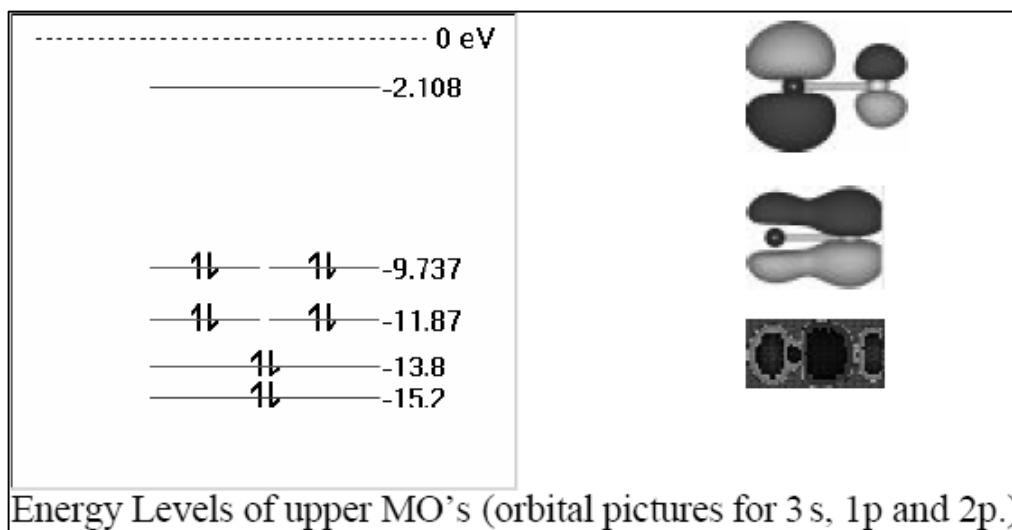

The photoelectron spectrum is complicated by the presence of **spin-orbit coupling**, which has the effect of splitting the ionization from the 2p level into two peaks. We take the average of these two peaks as the ionization energy. Agreement to the PM3 method is reasonable for this molecule. Above all, UV-PES establishes that the level ordering is that shown in the calculation, i.e. that the electron configuration is  $1s^2 2s^2 3s^2 1p^2 2p^2$  rather than the order observed for the heavier

dihalogen molecules which follow the “second-order” orbital sequence. You should confirm this by building the full MO diagram for ICl from the constituent atomic orbitals.

### (B) Triiodide anion

What structure is expected of  $I_3^-$ ? This is an important question, because most 3-atom molecules are indeed bent. However,  $I_3^-$  is a linear molecule. That is because it is based on the trigonal bipyramidal electron arrangement in the VESPR rationale of molecular structure:



To treat the bonding in a simple *on paper* fashion, we can make the approximation that each iodine uses a *pz* orbital as its principal basis AO in bonding to its neighbours. We can test this hypothesis later by a full MO treatment using HyperChem. Now consider what this arrangement should look like, and what its symmetry properties will be. There is an obvious logical link to our simple H<sub>3</sub> structures done at the beginning of the course. The topology of the three *pz* orbitals will then be:

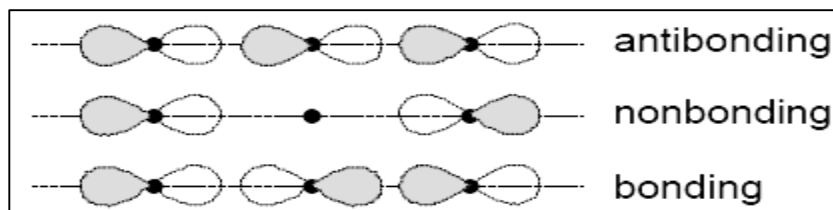

However, unlike the trihydrogen system where we used *s* orbitals, the bonding and antibonding combination of orbitals here will have *s u* symmetry, while the non-bonding has *s g* symmetry! The corresponding energy level diagram in which we

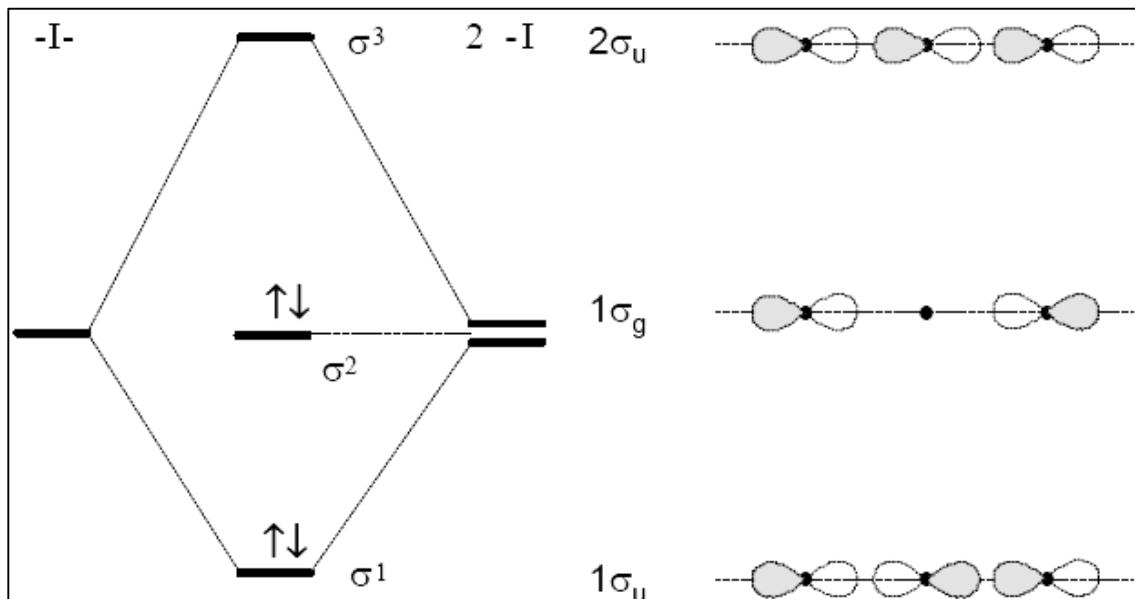

combine the two terminal iodide anions to the central I<sup>+</sup> ion is then expected to be:

Filling this simple scheme with the four available electrons fills the bonding  $1\sigma_u$  and the non-bonding  $1\sigma_g$  molecular orbitals. What then is the bond order? There are only two electrons but three bonded atoms. The overall bond order is then 1 and the order per bond is  $\frac{1}{2}$ . This is then another example of a delocalized (3c, 2e) bond, albeit of a different type from that observed in the bent bonds in  $B_2H_6$ . Such bonds are extremely common among the halogens and noble gases. The ease with which triiodide anions can be distorted by their environment can be rationalized by such weak bonding. We can now rationalize the linear geometry in  $I_3^-$  using these simple MO arguments, just as we did with a Walsh diagram for  $H_3^-$ . Remember that it is  $H_3^+$  which is predicted to be triangular, but the presence of the electrons in the  $1s_u$

orbital results in a linear geometry. Of course, in the true electronic structure of triiodide anion, there are many additional electrons of p symmetry that also contribute to the linear geometry. At the PM3 level of theory, amazingly, a picture very reminiscent of the above simple-minded bonding picture develops.

### (C) Bonding in a “hypervalent” compound: the example of $BrF_5$

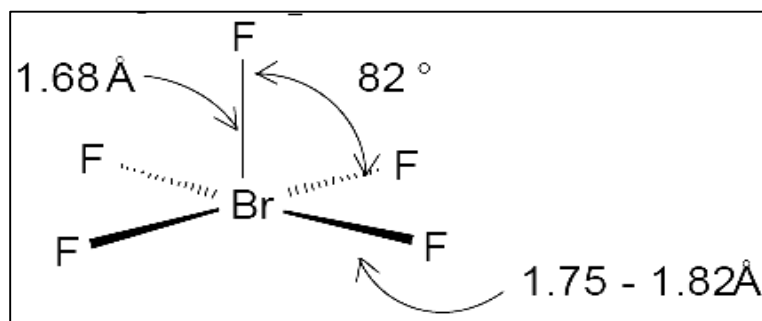



This is quite a remarkable structure. First of all, the atoms in the equatorial plane are actually bent up towards the axial fluorine, and not away from them. VSEPR rationalizes this result by pointing to a “lone-pair” on the Br that is large and needs more axial space. This, says the theory, causes the equatorial atoms to “bend up” out of the plane. Note also that the axial Br—F bond is considerably shorter than the four such bonds to the equatorial plane which are around 1.8 $\text{\AA}$  in length. Consider first a description of this structure using electron precise Lewis structures. Such structures must invoke so-called no-bond resonance to describe the bonding in this compound. Remember that the true Lewis diagram is a hybrid of all the contributing structures, so that the absence of a bond in any one of the five isomers does not imply that a bond is actually broken!

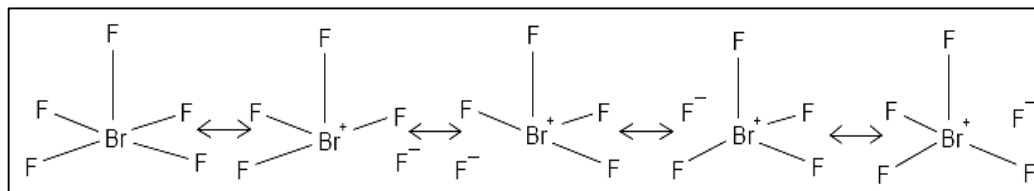

The full MO diagram of  $\text{BrF}_5$  is extremely complex, and we will restrict ourselves in this course to a simplified *on paper* MO diagram that uses only *s*-like functions for the fluorine atoms. This can be calculated in HyperChem using a model  $\text{BrH}_5$  molecule and by employing the extended Hückel MO method. First we need suitable SAO's for the five ligand *s* functions. These are not provided by the book, so we must make our own. These are modeled on the ones in the book for square planar geometry, but involve a different setting of the molecule w.r.t. the Cartesian coordinates. Here is such a set of SAO's:

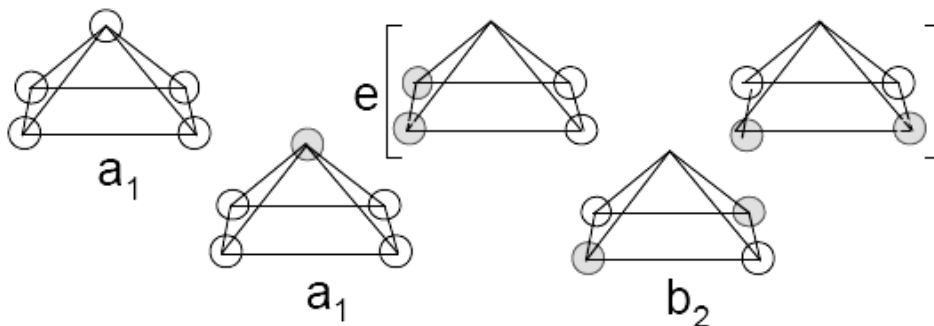

In this point group, the atomic orbitals transform as:  $s$  and  $p_z$  both transform as  $a_1$ , while  $p_x$  and  $p_y$  transform as a set as  $e$ . Remembering that fluorine is considerably more electronegative than bromine, we are ready to combine the central atom AO and the ligand SAO's. This is done on the following page. Now there are several points to consider in this bonding scheme. Note first of all that there is no  $b_2$  component on bromine. Hence the molecular  $b_2$  MO is at the exact energy of the ligand orbitals and is totally non-bonding. To a first approximation, the  $2a_1$  orbital is almost entirely dedicated to bonding in the axial direction, as shown in the HyperChem

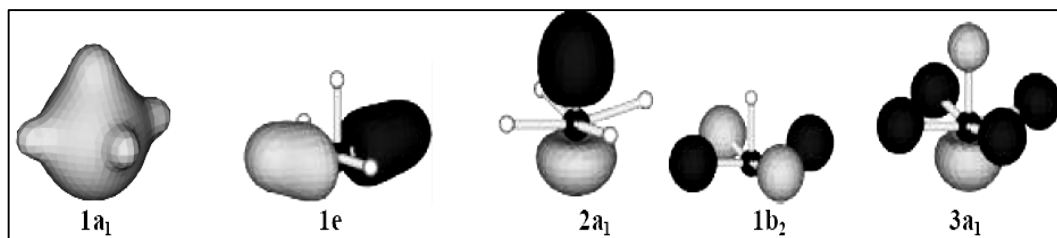

plots. By contrast,  $1a_1$  and  $1e$  are largely bonding in the equatorial plane, and  $3a_1$  is almost non-bonding. Hence the bond order for the axial direction is essentially 1, while for the equatorial direction is overall 3, or only 0.75 per Br—F bond! This then rationalizes the observed much longer bond lengths for the equatorial bonds compared to the axial bond. In the full MO picture, it is also possible that there is a  $p$ -component to the axial bonds that is not available to the equatorial set. Finally, in detailed MO calculations on this system it has been shown that the small F—Br—F bond angles between the axial and equatorial site enables the  $3a_1$  MO to gain a small degree of bonding character in the axial direction, and this helps to rationalize these small bond angles. Remember that in the VSEPR explanation, the upwards bending of these bonds is explained by the large “lone pair” below the  $\text{BrF}_4$  plane.

---

## 14.8 Pseudohalogen

---

The term pseudohalogen was first introduced by Lothar Birckenbach in 1925 and further developed and justified in a series of papers in the following years [1b-1d]. The anions  $\text{CN}^-$ ,  $\text{CNO}^-$ ,  $\text{N}_3^-$ ,  $\text{OCN}^-$ , and  $\text{SCN}^-$  can be coined classical linear pseudohalides. A small species can be classified as a classical pseudohalogen when it fulfills the following criteria with respect to a halogen-like chemical behaviour:

A pseudohalogen (X) forms

- ❖ a strongly bound (linear) univalent radical (X)
- ❖ a singly charged anion ( $\text{X}^-$ )
- ❖ a pseudohalogenhydrogen acid of the type HX
- ❖ salts of the type  $\text{M}(\text{X})_n$  with silver, lead and mercuric salts of low solubility,
- ❖ a neutral dipseudohalogen compound ( $\text{X}-\text{X}$ ) which disproportionates in water and can be added to double bonds, and interpseudohalogen species ( $\text{X}-\text{Y}$ ).

However, not all criteria are always met. While many linear pseudohalogens (e.g.  $\text{CN}$ ,  $\text{OCN}$ ,  $\text{CNO}$ ,  $\text{N}_3$ ,  $\text{SCN}$ ) are known, often the corresponding pseudohalide acids, dipseudohalogens, and interpseudohalogens are thermodynamically highly unstable (e.g.  $\text{HN}_3$ ,  $\text{OCN}-\text{NCO}$ ,  $\text{NC}-\text{SCN}$ ) with respect to  $\text{N}_2/\text{CO}$  elimination or polymerisation or indeed, remain unknown (e.g.  $\text{N}_3-\text{N}_3$ ).

---

## 14.9 Applications of Halogens

---

**Fluorine:** Although fluorine is very reactive, it serves many industrial purposes. For example, it is a key component of the plastic polytetrafluoroethylene (called Teflon-TFE by the DuPont company) and certain other polymers, often referred to as fluoropolymers. Chlorofluorocarbons (CFCs) are organic chemicals that were used as refrigerants and propellants in aerosols before growing concerns about their possible environmental impact led to their discontinued use. Hydrochlorofluorocarbons (HFCs) are now used instead. Fluoride is also added to

toothpaste and drinking water to help reduce tooth decay. Fluorine also exists in the clay used in some ceramics. Fluorine is associated with generating nuclear power as well. In addition, it is used to produce fluoroquinolones, which are antibiotics. Below is a list of some of fluorine's important inorganic compounds.

**Chlorine:** Chlorine has many industrial uses. It is used to disinfect drinking water and swimming pools. Sodium hypochlorite ( $\text{NaClO}$ ) is the main component of bleach. Hydrochloric acid, sometimes called muriatic acid, is a commonly used acid in industry and laboratories. Chlorine is also present in polyvinyl chloride (PVC), and several other polymers. PVC is used in wire insulation, pipes, and electronics. In addition, chlorine is very useful in the pharmaceutical industry. Medicinal products containing chlorine are used to treat infections, allergies, and diabetes. The neutralized form of hydrochloride is a component of many medications. Chlorine is also used to sterilize hospital machinery and limit infection growth. In agriculture, chlorine is a component of many commercial pesticides: DDT (dichlorodiphenyltrichloroethane) was used as an agricultural insecticide, but its use was discontinued.

**Bromine:** Bromine is used in flame retardants because of its fire-resistant properties. It also found in the pesticide methyl bromide, which facilitates the storage of crops and eliminates the spread of bacteria. However, the excessive use of methyl bromide has been discontinued due to its impact on the ozone layer. Bromine is involved in gasoline production as well. Other uses of bromine include the production of photography film, the content in fire extinguishers, and drugs treating pneumonia and Alzheimer's disease.

**Iodine:** Iodine is important in the proper functioning of the thyroid gland of the body. If the body does not receive adequate iodine, a goiter (enlarged thyroid gland) will form. Table salt now contains iodine to help promote proper functioning of the thyroid hormones. Iodine is also used as an antiseptic. Solutions used to clean open wounds likely contain iodine, and it is commonly found in disinfectant sprays. In addition, silver iodide is important for photography development.

Compound	Uses
$\text{Na}_3\text{AlF}_6$	Manufacture of aluminum
$\text{BF}_3$	Catalyst
$\text{CaF}_2$	Optical components, manufacture of HF, metallurgical flux
$\text{ClF}_3$	Fluorinating agent, reprocessing nuclear fuels
HF	Manufacture of $\text{F}_2$ , $\text{AlF}_3$ , $\text{Na}_3\text{AlF}_6$ , and fluorocarbons
LiF	Ceramics manufacture, welding, and soldering
NaF	Fluoridating water, dental prophylaxis, insecticide
$\text{SF}_6$	Insulating gas for high-voltage electrical equipment
$\text{SnF}_2$	Manufacture of toothpaste
$\text{UF}_6$	Manufacture of uranium fuel for nuclear reactors

**Astatine:** Because astatine is radioactive and rare, there are no proven uses for this halogen element. However, there is speculation that this element could aid iodine in regulating the thyroid hormones. Also it has been used in mice to aid the study of cancer.

---

## 14.10 Biological role of Halogen anions

---

**Fluoride anions** are found in ivory, bones, teeth, blood, eggs, urine, and hair of organisms. Fluoride anions in very small amounts are essential for humans. There are 0.5 milligrams per liter of fluorine in human blood. Human bones contain 0.2 to 1.2% fluorine. Human tissue contains approximately 50 parts per billion of fluorine. A typical 70-kilogram human contains 3 to 6 grams of fluorine.

**Chloride anions** are essential to a large number of species, humans included. The concentration of chlorine in the dry weight of cereals is 10 to 20 parts per million, while in potatoes the concentration of chloride is 0.5%. Plant growth is adversely affected by chloride levels in the soil falling below 2 parts per million. Human blood contains an average of 0.3% chlorine. Human bone contains typically contains 900 parts per million of chlorine. Human tissue contains approximately 0.2 to 0.5% chlorine. There is a total of 95 grams of chlorine in a typical 70-kilogram human.

**Bromine** in the form of the bromide anion is present in all organisms. A biological role for bromine in humans has not been proven, but some organisms contain organobromine compounds. Humans typically consume 1 to 20 milligrams of bromine per day. There are typically 5 parts per million of bromine in human blood, 7 parts per million of bromine in human bones, and 7 parts per million of bromine in human tissue. A typical 70-kilogram human contains 260 milligrams of bromine. Humans typically consume less than 100 micrograms of iodine per day.

**Iodine** deficiency can cause intellectual disability. Organoiodine compounds occur in humans in some of the glands, especially the thyroid gland, as well as the stomach, epidermis, and immune system. Foods containing iodine include cod, oysters, shrimp, herring, lobsters, sunflower seeds, seaweed, and mushrooms. However, iodine is not known to have a biological role in plants. There are typically 0.06 milligrams per liter of iodine in human blood, 300 parts per billion of iodine in human bones, and 50 to 700 parts per billion of iodine in human tissue. There are 10 to 20 milligrams of iodine in a typical 70-kilogram human.

**Astatine** has no biological role.

---

## 14.11 Toxicity of Halogen Elements

---

The halogens tend to decrease in toxicity towards the heavier halogens.

Fluorine gas is extremely toxic; breathing fluorine gas at a concentration of 0.1% for several minutes is lethal. Hydrofluoric acid is also toxic, being able to penetrate skin and cause highly painful burns. In addition, fluoride anions are toxic, but not as toxic as pure fluorine. Fluoride can be lethal in amounts of 5 to 10 grams. Prolonged consumption of fluoride above concentrations of 1.5 mg/L is associated with a risk of dental fluorosis, an aesthetic condition of the teeth. At concentrations above 4 mg/L, there is an increased risk of developing skeletal fluorosis, a condition in which bone fractures become more common due to the hardening of bones. Current recommended levels in water fluoridation, a way to prevent dental caries, range from 0.7-1.2 mg/L to avoid the detrimental effects of fluoride while at the same time reaping the benefits. People with levels between normal levels and those required for skeletal fluorosis tend to have symptoms similar to arthritis.

Chlorine gas is highly toxic. Breathing in chlorine at a concentration of 3 parts per million can rapidly cause a toxic reaction. Breathing in chlorine at a concentration of 50 parts per million is highly dangerous. Breathing in chlorine at a concentration of 500 parts per million for a few minutes is lethal. Breathing in chlorine gas is highly painful. Hydrochloric acid is a dangerous chemical. Pure bromine is somewhat toxic, but less toxic than fluorine and chlorine. One hundred milligrams of bromine are lethal. Bromide anions are also toxic, but less so than bromine. Bromide has a lethal dose of 30 grams. Iodine is somewhat toxic, being able to irritate the lungs and eyes, with a safety limit of 1 milligram per cubic meter. When taken orally, 3 grams of iodine can be lethal. Iodide anions are mostly nontoxic, but these can also be deadly if ingested in large amounts. Astatine is very radioactive and thus highly dangerous.

---

## **14.12 Summary**

---

This Chapter increase the knowledge of learner for halogen family and bonding in interhalogens and halogen oxyacids and oxoanions, their synthesis, reactions and structure. Chapter also explain brief about biological role of halogen anions with applications of halogens.

---

## **14.13 Review Question**

---

1. Define oxyacids and oxoanions?
  2. What are bonding in interhalogens gives synthesis, reaction and structure of interhalogens compounds?
  3. What are Pseudohalogen compounds, explain?
  4. Define interhalogens?
  5. Explain periodic trend in halogen family?
- 

## **14.14 Reference and Suggested readings**

---

1. Greenwood, Norman N.; Earnshaw, Alan (1997). Chemistry of the Elements (2nd ed.). Butterworth-Heinemann. ISBN 0080379419.

2. Hill, Graham, and John Holman. *Chemistry in Context*. 5th ed. United Kingdom: Nelson Thornes, 2000. 224-25.



---

# Unit - 15 : Noble Gases

---

## Structure of unit

- 15.0 Objectives
- 15.1 Introduction
- 15.2 Noble Gas
- 15.3 Characteristics of Noble Gases
- 15.4 Synthesis, properties, uses, structure & bonding of Noble Gases
- 15.5 Summary
- 15.6 Review questions
- 15.7 References and suggested readings

---

## 15.0 Objectives

---

- At the end of the unit learner will be able to
- Understand the basic properties of noble gases.
- Their definitions and characteristics.
- Synthesis, properties, uses, structure & bonding of Noble Gases

---

## 15.1 Introduction

---

The unit contains the basic knowledge of noble gases, these are defined as "the group of chemical elements with low chemical reactivity." In most natural conditions they cannot form chemical compounds and their abundances and isotopic ratios are only affected by physical processes such as kinetic effects, phase changes and nuclear reactions including radioactivity.

These are usually referred as noble gases. Each has a filled set of s and p orbitals in its valence level. Filling one s and three p orbitals requires eight electrons. So the filled octet of electrons we call as noble gas configuration.

Helium is less dense than any other known gas except hydrogen and is about one seventh as dense as air. Extremely unreactive, it is an inert gas in Group 18 of

the periodic table. Natural helium is a mixture of two stable isotopes, helium-3 and helium-4.

A mixture of He and O<sub>2</sub> is also used to assist breathing in asthma and other respiratory diseases because this mixture is lighter than air.

Neon is the second-lightest noble gas, after helium. It glows reddish-orange in a vacuum discharge tube. Also, neon has the narrowest liquid range of any element: from 24.55 K to 27.05 K. It has over 40 times the refrigerating capacity of liquid helium and three times that of liquid hydrogen.

Neon is used in neon discharge tubes which give familiar reddish orange yellow glow of neon signs.

Neon is often used in signs and produces an unmistakable bright reddish-orange light.

Argon has approximately the same solubility in water as oxygen, and is 2.5 times more soluble in water than nitrogen. Argon is colorless, odourless, nonflammable and nontoxic as a solid, liquid, and gas. Argon is chemically inert under most conditions and forms no confirmed stable compounds at room temperature.

Argon provides inert atmosphere for metallurgy.

An inert gas is needed. In particular, argon is the cheapest alternative when nitrogen is not sufficiently inert.

Krypton is characterized by several sharp emission lines (spectral signatures) the strongest being green and yellow. It is one of the products of uranium fission. Solidified krypton is white and crystalline with a face-centered cubic crystal structure

Krypton is used in some types of photographic flashes used in high speed photography. Krypton gas is also combined with other gases to make luminous signs that glow with a bright greenish-yellow light.

Xenon has atomic number 54; that is, its nucleus contains 54 protons. At standard temperature and pressure, pure xenon gas has a density of 5.761 kg/m<sup>3</sup>, about 4.5 times the surface density of the Earth's atmosphere, 1.217 kg/m<sup>3</sup>. Using giga pascals of pressure, xenon has been forced into a metallic phase.

Although xenon is rare and relatively expensive to extract from Earth's atmosphere, it has a number of applications.

Radon is a colorless, odourless, and tasteless gas. At standard temperature and pressure, radon forms a monatomic gas with a density of 9.73 kg/m<sup>3</sup>, about 8 times the density of the Earth's atmosphere at sea level, 1.217 kg/m<sup>3</sup>. Radon is one of the densest gases at room temperature and is the densest of the noble gases. Although colorless at standard temperature and pressure, when cooled below its freezing point of 202 K, radon emits a brilliant radio luminescence that turns from yellow to orange-red as the temperature lowers.

Radon's molecule-damaging radioactivity has been used to kill cancerous cells. An apparatus for (allegedly) dissolving radon into drinking water, in a restaurant in Japan. Exposure to radon, a process known as radiation hormesis, has been suggested to mitigate auto-immune diseases such as arthritis. Radon has been produced commercially for use in radiation therapy, but for the most part has been replaced by radio nuclides made in accelerators and nuclear reactors.

---

## 15.2 Noble Gas

---

The noble gases are a family of chemically inert elements with a systematic mass-dependent variation in their respective physical properties. The number of electrons in the outermost shell of the noble gas atoms is always eight, except helium which has two electrons.

### Noble Gas Definition

The noble gases are defined as "**the group of chemical elements with low chemical reactivity.**" In most natural conditions they cannot form chemical compounds and their abundances and isotopic ratios are only affected by physical processes such as kinetic effects, phase changes and nuclear reactions including radioactivity.

The noble gases have all their electronic shells saturated and therefore cannot readily make compounds.

### Noble Gas Uses

1. Krypton and xenon are used in filling incandescent metal filament electrical bulbs as these gases are found superior to argon for this purpose.

2. Radon is useful in the treatment of cancer because it is radioactive in nature.

---

### 15.3 Characteristics of Noble Gases

---

1. **Electronic configuration** - All noble gases except helium have highly stable general electronic configuration in the valence shell that is  $ns^2np^6$ . Helium has  $ns^2$  stable configuration.
2. **Atomic radii** - Atomic radii of noble gases increases on moving down the group and their atomic radii correspond to the van der Waals radii.
3. **Boiling points** - As the magnitude of van der Waals forces increases down the group, boiling points also increases in the same order.
4. **Ease of liquefaction** - The van der Waals forces in these gases are weak, as such these gases are relatively difficult to be liquefied. Further as the van der Waals forces increase from He to Xe, the ease of liquefaction increases with increase in atomic weight.
5. **Polarisability** - The polarisability of the electron clouds in valence shell increases down the group as these electron clouds get away from nucleus as one goes down in the group.
6. **Ionization energy and electron affinity** - These elements have stable  $ns^2np^6$  electronic configuration therefore they have no tendency to lose or gain electrons.
7. **Solubility** - They are generally less soluble in water. However their solubility increases with increase in atomic weight down the group.
8. **Electrical conductivity** - Noble gases have fairly good electrical conductivity at low pressure and high voltage.
9. **Chemical reactivity** - Krypton, xenon and radon have been found to react chemically and the reactivity increases down the group.

#### Noble Gases on Periodic Table

The noble gases were not known at the time Mendeleev when he gave his original classification of elements. After the discovery of these elements a new group was introduced in the periodic table. Because of chemical inertness of these gases,

these were assigned zero valency and the group in which they were placed was designated as zero group.

The zero group falls after the seventh group and before the first group between most electronegative halogens and the most electropositive alkali metals. The place of noble gas in periodic table is shown below.

### **Noble Gas Configuration Chart**

It has been recognized that the group-VIII A elements are extremely unreactive. These are usually referred as noble gases. Each has a filled set of s and p orbitals in its valence level. Filling one s and three p orbitals requires eight electrons. So the filled octet of electrons we call as noble gas configuration.

### **Heaviest Noble Gas**

Radon is the heaviest noble gas having 86 electron and boils at  $-62^{\circ}\text{C}$ . The average atomic weight is 222. It's not having any stable isotopes.

### **Lightest Noble Gas**

Helium is the lightest noble gas and its configuration is  $1s^2$  which means only one electron are in the filled energy level. Helium does not form chemical bonds.

### **Radioactive Noble Gas**

Radon is a radioactive noble gas element, which is obtained by radioactive disintegration of radium, while all other noble gases are present in atmosphere. Gases He, Ne and Ar are also called "Aerogens."

### **Noble Gas Colors**

Xenon: Turquoise light blue

Radon: Deep red

### **Noble Gas Electron Configuration**

Zero group of Mendeleev's periodic table or the group 18 of long form of periodic table is comprised of six elements. The electronic configuration is listed in the following table.

S.No	Element	Symbol	Atomic number	Electronic configuration
1	Helium	He	2	$1s^2$
2	Neon	Ne	10	$[\text{He}] 2s^2 2p^6$
3	Argon	Ar	18	$[\text{Ne}] 3s^2 3p^6$
4	Krypton	Kr	36	$[\text{Ar}] 3d^{10} 4s^2 4p^6$
5	Xenon	Xe	54	$[\text{Kr}] 4d^{10} 5s^2 5p^6$
6	Radon	Rn	86	$[\text{Xe}] 4f^{14} 5d^{10} 6s^2 6p^6$

### Noble Gas Properties

1. All the elements are colorless and odourless mono atomic gases.
2. The boiling point of helium is lowest of any element. It is only four degrees above absolute zero.
3. The noble gases are able to diffuse through glass, rubber, plastic materials and some metals.
4. The atomic radii of the elements are all very large and increase on descending the group.
5. Noble gases readily form clathrate compounds.
6. All the compounds of noble gases are sparingly soluble in water.

---

## 15.4 Synthesis, properties, uses, structure & bonding of Noble Gases

---

### 15.4.1 Helium

Helium's noncombustibility and buoyancy (second only to hydrogen) make it the most suitable gas for balloons and other lighter-than-air craft. A mixture of helium and oxygen is often supplied as a breathing mixture for deep-sea divers and caisson workers and is used in decompression chambers; because helium is less soluble in human blood than nitrogen, its use reduces the risk of caisson disease, or the "bends." Helium can also be used wherever an unreactive atmosphere is needed, e.g., in electric arc welding, in growing crystals of silicon and germanium for

semiconductors, and in refining titanium and zirconium metals. It is also used to pressurize the fuel tanks of liquid-fueled rockets. Liquid helium is essential for many low temperature applications

**Colour:** Helium: Light yellow to orange

### **Properties**

Helium is less dense than any other known gas except hydrogen and is about one seventh as dense as air. Extremely unreactive, it is an inert gas in Group 18 of the periodic table. Natural helium is a mixture of two stable isotopes, helium-3 and helium-4.

Helium-4 is unusual in that it forms two different kinds of liquids. When it is cooled below 4.22°K (its boiling point at atmospheric pressure) it condenses to liquid helium-I, which behaves as an ordinary liquid. When liquid helium-I is cooled below about 2.18°K (at atmospheric pressure), liquid helium-II is formed. It is sometimes called a superfluid because it has extremely low viscosity. It also has extremely high heat conductivity and expands on cooling. When helium-3 is liquefied and cooled it does not exhibit the properties of liquid helium-II.

### **Preparation**

Helium is rare and costly. Wells in Texas, Oklahoma, and Kansas are the principal world source. Crude helium is separated by liquefying the other gases present in the natural gas. Some helium is extracted directly from the atmosphere; the gas is also found in certain uranium minerals and in some mineral waters, but not in economic quantities. Helium is abundant in outer space; it makes up about 23% of the mass of the visible universe. It is the end product of energy-releasing fusion processes in stars

### **Uses**

A mixture of He and O<sub>2</sub> is also used to assist breathing in asthma and other respiratory diseases because this mixture is lighter than air.

Helium is used in preference to N<sub>2</sub> to dilute O<sub>2</sub> in gas cylinders used by sea divers. Helium's noncombustibility and buoyancy (second only to hydrogen) make it the most suitable gas for balloons and other lighter-than-air craft. Helium can also be used wherever an unreactive atmosphere is needed, e.g., in electric arc welding, in

growing crystals of silicon and germanium for semiconductors, and in refining titanium and zirconium metals. It is also used to pressurize the fuel tanks of liquid-fueled rockets. Liquid helium is essential for many low temperature applications

#### **15.4.2 Neon**

Neon is a chemical element with symbol Ne and atomic number 10. It is in group 18 (noble gases) of the periodic table. Neon is a colorless, odorless, inert monatomic gas under standard conditions, with about two-thirds the density of air. It was discovered (along with krypton and xenon) in 1898. After discovery it was immediately recognized as a new element from its bright red emission spectrum.

The name neon is derived from the Greek word, **νέον**, neuter meaning new. Neon is chemically inert and forms no uncharged chemical compounds.

Although neon is a very common element in the universe and solar system (it is fifth in cosmic abundance after hydrogen, helium, oxygen and carbon), it is very rare on Earth. It composes about 18.2 ppm of air by volume and a smaller fraction in Earth's crust. The reason for neon's relative scarcity on Earth and the inner (terrestrial) planets, is that neon forms no compounds to fix it to solids, and is highly volatile,

Neon gives a distinct reddish-orange glow when used in either low-voltage neon glow lamps or in high-voltage discharge tubes. The red emission line from neon is also responsible for the well known red light of helium-neon lasers. Neon is used in a few plasma tube and refrigerant applications but has few other commercial uses. It is commercially extracted by the fractional distillation of liquid air. It is considerably more expensive than helium, since air is its only source.

#### **Colour:**

Neon: Reddish-orange

#### **Properties**

Neon is the second-lightest noble gas, after helium. It glows reddish-orange in a vacuum discharge tube. Also, neon has the narrowest liquid range of any element: from 24.55 K to 27.05 K. It has over 40 times the refrigerating capacity of liquid helium and three times that of liquid hydrogen. In most applications it is a less expensive refrigerant than helium. The average color of this light to the human eye



is red-orange due to many lines in this range; it also contains a strong green line which is hidden. Neon glow lamps are generally tiny, with most operating at about 100–250 volts. They have been widely used as power-on indicators and in circuit-testing equipment, but light-emitting diodes (LEDs) now dominate in such applications. These simple neon devices were the forerunners of plasma displays and plasma television screens. The glass tubing is often formed into shapes and letters for signage as well as architectural and artistic applications.

### **Occurrence**

Stable isotopes of neon are produced in stars.  $^{20}\text{Ne}$  is created in fusing helium and oxygen in the alpha process, which requires temperatures above 100 megakelvins and masses greater than 3 solar masses. Its relative rarity on Earth, like that of helium, is due to its relative lightness, high vapor pressure at very low temperatures, and chemical inertness, all properties which tend to keep it from being trapped in the condensing gas and dust clouds which resulted in the formation of smaller and warmer solid planets like Earth. Neon is rare on Earth, found in the Earth's atmosphere at 1 part in 55,000, or 18.2 ppm by volume. It comprises a smaller fraction in the crust. It is industrially produced by cryogenic fractional distillation of liquefied air.

### **Uses**

Neon is used in neon discharge tubes which give familiar reddish orange yellow glow of neon signs.

Neon is often used in signs and produces an unmistakable bright reddish-orange light.

Neon is used in vacuum tubes, high-voltage indicators, lightning arrestors, wave meter tubes, television tubes, and helium-neon lasers. Liquefied neon is commercially used as a cryogenic refrigerant in applications not requiring the lower temperature range attainable with more extreme liquid helium refrigeration.

### **15.4.3 Argon**

Argon is a chemical element with symbol Ar and atomic number 18. It is in group 18 of the periodic table and is a noble gas. Argon is the third most common gas in the Earth's atmosphere, at 0.93% (9,300 ppm), Nearly all of this argon

is radiogenic argon-40 derived from the decay of potassium-40 in the Earth's crust. In the universe, argon-36 is by far the most common argon isotope.

The name "argon" is derived from the Greek word  $\alpha\rho\gamma\omega\nu$ , neuter singular form of  $\alpha\rho\gamma\omicron\varsigma$  meaning "lazy" or "inactive", as a reference to the fact that the element undergoes almost no chemical reactions. The complete octet (eight electrons) in the outer atomic shell makes argon stable and resistant to bonding with other elements.

Argon is produced industrially by the fractional distillation of liquid air. Argon is mostly used as an inert shielding gas in welding and other high-temperature industrial processes where ordinarily non-reactive substances become reactive; for example, an argon atmosphere is used in graphite electric furnaces to prevent the graphite from burning. Argon gas also has uses in incandescent and fluorescent lighting, and other types of gas discharge tubes. Argon makes a distinctive blue-green gas laser.

### **Properties**

Argon has approximately the same solubility in water as oxygen, and is 2.5 times more soluble in water than nitrogen. Argon is colorless, odorless, nonflammable and nontoxic as a solid, liquid, and gas. Argon is chemically inert under most conditions and forms no confirmed stable compounds at room temperature.

Although argon is a noble gas, it has been found to have the capability of forming some compounds. For example, the creation of argon fluorohydride (HArF) is a marginally stable compound of argon with fluorine and hydrogen. Although the neutral ground-state chemical compounds of argon are presently limited to HArF, argon can form clathrates with water when atoms of it are trapped in a lattice of the water molecules. Argon-containing ions and excited state complexes, such as  $\text{ArH}^+$  and  $\text{ArF}$ , respectively, are known to exist. Theoretical calculations have predicted several argon compounds that should be stable, but for which no synthesis routes are currently known.

### **Colour:**

Argon: Purple to pale lavender blue

## **Preparation**

Argon constitutes 0.934% by volume and 1.288% by mass of the Earth's atmosphere, and air is the primary raw material used by industry to produce purified argon products. Argon is isolated from air by fractionation, most commonly by cryogenic fractional distillation.

## **Industrial**

Argon is produced industrially by the fractional distillation of liquid air in a cryogenic air separation unit; a process that separates liquid nitrogen, which boils at 77.3 K, from argon, which boils at 87.3 K, and liquid oxygen, which boils at 90.2 K. About 700,000 tones of argon are produced worldwide every year.

## **In radioactive decays**

$^{40}\text{Ar}$ , the most abundant isotope of argon, is produced by the decay of  $^{40}\text{K}$  with a half-life of  $1.25 \times 10^9$  years by electron capture or positron emission. Because of this, it is used in potassium-argon dating to determine the age of rocks.

## **Uses**

- Argon provides inert atmosphere for metallurgy.
- An inert gas is needed. In particular, argon is the cheapest alternative when nitrogen is not sufficiently inert.
- Low thermal conductivity is required.
- The electronic properties (ionization and/or the emission spectrum) are necessary.

Argon is by far the cheapest. Argon is inexpensive since it occurs naturally in air, and is readily obtained as a byproduct of cryogenic air separation in the production of liquid oxygen and liquid nitrogen: the primary constituents of air are used on a large industrial scale. Argon produce is the most plentiful by far. The bulk of argon applications arise simply because it is inert and relatively cheap.

Following are the different fields in which argon is used

## **Industrial processes**

Argon is used in some high-temperature industrial processes, where ordinarily non-reactive substances become reactive. Argon is used in various types of arc

welding such as gas metal arc welding and gas tungsten arc welding, as well as in the processing of titanium and other reactive elements. An argon atmosphere is also used for growing crystals of silicon and germanium.

Argon is used in the poultry industry to asphyxiate birds, either for mass culling following disease outbreaks, or as a means of slaughter more humane than the electric bath. Argon's relatively high density causes it to remain close to the ground during gassing. Its non-reactive nature makes it suitable in a food product, and since it replaces oxygen within the dead bird, argon also enhances shelf life.

Argon is sometimes used for extinguishing fires where damage to equipment is to be avoided.

### **Preservative**

Argon is used to displace oxygen- and moisture-containing air in packaging material to extend the shelf-lives of the contents (argon has the European food additive code of *E938*). Aerial oxidation, hydrolysis, and other chemical reactions which degrade the products are retarded or prevented entirely. Bottles of high-purity chemicals and certain pharmaceutical products are available in sealed bottles or ampoules packed in argon. In wine making, argon is used to top-off barrels to avoid the aerial oxidation of ethanol to acetic acid during the aging process.

Argon is also available in aerosol-type cans, which may be used to preserve compounds such as varnish, polyurethane, paint, etc. for storage after opening.

### **Laboratory equipment**

Argon may be used as the inert gas within Schlenk lines and glove boxes. The use of argon over comparatively less expensive nitrogen is preferred where nitrogen may react with the experimental reagents or apparatus.

Argon may be used as the carrier gas in gas chromatography and in electrospray ionization mass spectrometry; it is the gas of choice for the plasma used in ICP spectroscopy. Argon is preferred for the sputter coating of specimens for scanning electron microscopy.

### **Medical use**

Cryosurgery procedures such as cryoablation use liquefied argon to destroy cancer cells. Blue argon lasers are used in surgery to weld arteries, destroy

tumors, and to correct eye defects. It has also been used experimentally to replace nitrogen in the breathing or decompression mix, to speed the elimination of dissolved nitrogen from the blood.

### **Lighting**

Incandescent lights are filled with argon, to preserve the filaments at high temperature from oxidation. Gas-discharge lamps filled with argon provide blue light. Argon is also used for the creation of blue and green laser light.

### **Miscellaneous uses**

Argon is used for thermal insulation in energy efficient windows. Argon is also used in technical scuba diving to inflate a dry suit, because it is inert and has low thermal conductivity. Argon is being used as a propellant in the development of the Variable Specific Impulse Magneto plasma Rocket (VASIMR). Argon-39, with a half-life of 269 years, has been used for a number of applications, primarily ice core and ground water dating. Also, potassium-argon dating is used in dating igneous rocks.

### **Krypton**

Krypton (from Greek: κρυπτός kryptos "the hidden one") is a chemical element with symbol Kr and atomic number 36. It is a member of group 18 (noble gases) elements. A colorless, odorless, tasteless noble gas, krypton occurs in trace amounts in the atmosphere, is isolated by fractionally distilling liquified air, and is often used with other rare gases in fluorescent lamps. Krypton is inert for most practical purposes.

### **Properties**

Krypton is characterized by several sharp emission lines (spectral signatures) the strongest being green and yellow. It is one of the products of uranium fission. Solidified krypton is white and crystalline with a face-centered cubic crystal structure,

### **Natural Occurrence**

Krypton's concentration in the atmosphere is about 1 ppm. It can be extracted from liquid air by fractional distillation. The amount of krypton in space is uncertain, as the amount is derived from the meteoric activity and that from solar winds.

## Uses

Krypton is used in some types of photographic flashes used in high speed photography. Krypton gas is also combined with other gases to make luminous signs that glow with a bright greenish-yellow light.

Krypton mixes with argon as the fill gas of energy saving fluorescent lamps. This reduces their power consumption. Krypton is used to fill incandescent lamps to reduce filament evaporation and allow higher operating temperatures to be used for the filament. A brighter light results which contains more blue than conventional lamps.

Krypton's white discharge is often used to good effect in colored gas discharge tubes. Krypton is also capable of much higher light power density than neon in the red spectral line region. Krypton has an important role in production and usage of the krypton fluoride laser. The laser has been important in the nuclear fusion energy research community in confinement experiments. The laser has high beam uniformity, short wavelength, and the ability to modify the spot size to track an imploding pellet.

Krypton-83 has application in magnetic resonance imaging (MRI) for imaging airways.

## Xenon

**Xenon** is a chemical element with the symbol **Xe** and atomic number 54. It is a colorless, heavy, odorless noble gas, which occurs in the Earth's atmosphere in trace amounts. Although generally unreactive, xenon can undergo a few chemical reactions such as the formation of xenon hexafluoroplatinate, the first noble gas compound to be synthesized.

Naturally occurring xenon consists of eight stable isotopes. There are also over 40 unstable isotopes that undergo radioactive decay. The isotope ratios of xenon are an important tool for studying the early history of the Solar System. Radioactive xenon-135 is produced from iodine-135 as a result of nuclear fission, and it acts as the most significant neutron absorber in nuclear reactors.

## Properties

Xenon has atomic number 54; that is, its nucleus contains 54 protons. At standard temperature and pressure, pure xenon gas has a density of  $5.761 \text{ kg/m}^3$ , about 4.5 times the surface density of the Earth's atmosphere,  $1.217 \text{ kg/m}^3$ . Using gigapascals of pressure, xenon has been forced into a metallic phase.

- Solid xenon changes from face-centered cubic (fcc) to hexagonal close packed (hcp) crystal phase under pressure and begins to turn metallic at about 140 GPa, with no noticeable volume change in the hcp phase. It is completely metallic at 155 GPa. When metalized, xenon looks sky blue because it absorbs red light and transmits other visible frequencies. Such behavior is unusual for a metal and is explained by the relatively small widths of the electron bands in metallic xenon.

Xenon is a member of the zero-valence elements that are called noble or inert gases. It is inert to most common chemical reactions because the outer valence shell contains eight electrons. This produces a stable, minimum energy configuration in which the outer electrons are tightly bound. However, xenon can be oxidized by powerful oxidizing agents, and many xenon compounds have been synthesized.

## Preparation

Xenon is a trace gas in Earth's atmosphere, approximately 1 part per 11.5 million, and is also found in gases emitted from some mineral springs.

Xenon is obtained commercially as a byproduct of the separation of air into oxygen and nitrogen. After this separation, generally performed by fractional distillation in a double-column plant, the liquid oxygen produced will contain small quantities of krypton and xenon. By additional fractional distillation steps, the liquid oxygen may be enriched to contain 0.1–0.2% of a krypton/xenon mixture, which is extracted either via adsorption onto silica gel or by distillation. Finally, the krypton/xenon mixture may be separated into krypton and xenon via distillation. Extraction of a liter of xenon from the atmosphere requires 220 watt-hours of energy. Because of its low abundance, xenon is much more expensive than the lighter noble gases

## **Applications**

Although xenon is rare and relatively expensive to extract from Earth's atmosphere, it has a number of applications.

### **Illumination and optics**

#### **Gas-discharge lamps**

Xenon is used in light-emitting devices called xenon flash lamps, which are used in photographic flashes and stroboscopic lamps.

The first solid-state laser, invented in 1960, was pumped by a xenon flash lamp, and lasers used to power inertial confinement fusion are also pumped by xenon flash lamps

#### **Lasers**

In 1962, a group of researchers at Bell Laboratories discovered laser action in xenon. The first excimer laser used a xenon dimer ( $\text{Xe}_2$ ) energized by a beam of electrons to produce stimulated emission at an ultraviolet wavelength of 176 nm. Xenon chloride and xenon fluoride have also been used in excimer (or, more accurately, exciplex) lasers. The xenon chloride excimer laser has been employed, for example, in certain dermatological uses.

### **Medical**

#### **Anesthesia**

Xenon has been used as a general anesthetic. Although it is expensive, anesthesia machines that can deliver xenon are about to appear on the European market, because advances in recovery and recycling of xenon have made it economically viable.

#### **Neuroprotectant**

Xenon induces robust cardioprotection and neuroprotection through a variety of mechanisms of action. Through its influence on  $\text{Ca}^{2+}$ ,  $\text{K}^+$ ,  $\text{KATP}$ \HIF and NMDA antagonism xenon is neuroprotective when administered before, during and after ischemic insults. Xenon is a high affinity antagonist at the NMDA receptor glycine site. Xenon is cardioprotective in ischemia-reperfusion conditions by inducing pharmacologic non-ischemic preconditioning. Xenon is cardioprotective by activating PKC-epsilon & downstream p38-MAPK. Xenon mimics neuronal



ischemic preconditioning by activating ATP sensitive potassium channels. Xenon allosterically reduces ATP mediated channel activation inhibition independently of the sulfonylurea receptor1 subunit, increasing KATP open-channel time and frequency.

### **Doping**

Inhaling a xenon/oxygen mixture activates production of the transcription factor HIF-1-alpha, which leads to increased production of erythropoietin. The latter hormone is known to increase red blood cell production and athletes' performance.

### **Imaging**

Gamma emission from the radioisotope  $^{133}\text{Xe}$  of xenon can be used to image the heart, lungs, and brain, for example, by means of single photon emission computed tomography.  $^{133}\text{Xe}$  has also been used to measure blood flow.

### **NMR spectroscopy**

Because of the atom's large, flexible outer electron shell, the NMR spectrum changes in response to surrounding conditions, and can therefore be used as a probe to measure the chemical circumstances around the xenon atom. For instance xenon dissolved in water, xenon dissolved in hydrophobic solvent, and xenon associated with certain proteins can be distinguished by NMR.

### **Radon**

Radon is a chemical element with symbol Rn and atomic number 86. It is a radioactive, colorless, odourless, tasteless noble gas, occurring naturally as an indirect decay product of uranium or thorium. Its most stable isotope,  $^{222}\text{Rn}$ , has a half-life of 3.8 days. Radon is one of the densest substances that remain a gas under normal conditions. It is also the only gas under normal conditions that only has radioactive isotopes, and is considered a health hazard due to its radioactivity. Intense radioactivity has also hindered chemical studies of radon and only a few compounds are known.

### **Properties**

Radon is a colorless, odourless, and tasteless gas. At standard temperature and pressure, radon forms a monatomic gas with a density of  $9.73 \text{ kg/m}^3$ , about 8 times

the density of the Earth's atmosphere at sea level, 1.217 kg/m<sup>3</sup>. Radon is one of the densest gases at room temperature and is the densest of the noble gases. Although colorless at standard temperature and pressure, when cooled below its freezing point of 202 K, radon emits a brilliant radio luminescence that turns from yellow to orange-red as the temperature lowers.

Being a noble gas, radon is chemically not very reactive. However, in accordance with periodic trends, radon has a lower electro-negativity than the element one period before it, xenon, and is therefore more reactive. Radon is sparingly soluble in water, but more soluble than lighter noble gases. Radon is appreciably more soluble in organic liquids than in water.

### **Preparation**

Radon is obtained as a by-product of uraniferous ores processing after transferring into 1% solutions of hydrochloric or hydrobromic acids. The gas mixture extracted from the solutions contains H<sub>2</sub>, O<sub>2</sub>, He, Rn, CO<sub>2</sub>, H<sub>2</sub>O and hydrocarbons. The mixture is purified by passing it over copper at 720 °C to remove the H<sub>2</sub> and the O<sub>2</sub>, and then KOH and P<sub>2</sub>O<sub>5</sub> are used to remove the acids and moisture by sorption. Radon is condensed by liquid nitrogen and purified from residue gases by sublimation.

### **Uses**

Radon's molecule-damaging radioactivity has been used to kill cancerous cells. An apparatus for (allegedly) dissolving radon into drinking water, in a restaurant in Japan. Exposure to radon, a process known as radiation hormesis, has been suggested to mitigate auto-immune diseases such as arthritis. Radon has been produced commercially for use in radiation therapy, but for the most part has been replaced by radio nuclides made in accelerators and nuclear reactors. Radon has been used in implantable seeds, made of gold or glass, primarily used to treat cancers. In the early part of the 20<sup>th</sup> century in the USA, gold contaminated with <sup>210</sup>Pb entered the jewelry industry. This was from gold seeds that had held <sup>222</sup>Rn that had been melted down after the radon had decayed.

---

## 15.5 Summary

---

The noble gases are defined as "**the group of chemical elements with low chemical reactivity.**" In most natural conditions they cannot form chemical compounds and their abundances and isotopic ratios are only affected by physical processes such as kinetic effects, phase changes and nuclear reactions including radioactivity

### Noble Gas Properties

1. All the elements are colorless and odorless mono atomic gases.
2. The boiling point of helium is lowest of any element. It is only four degrees above absolute zero.
3. The noble gases are able to diffuse through glass, rubber, plastic materials and some metals.

Helium's noncombustibility and buoyancy (second only to hydrogen) make it the most suitable gas for balloons and other lighter-than-air craft. A mixture of helium and oxygen is often supplied as a breathing mixture for deep-sea divers and caisson workers and is used in decompression chambers; because helium is less soluble in human blood than nitrogen, its use reduces the risk of caisson disease, or the "bends." Helium can also be used wherever an unreactive atmosphere is needed, e.g., in electric arc welding, in growing crystals of silicon and germanium for semiconductors, and in refining titanium and zirconium metals. It is also used to pressurize the fuel tanks of liquid-fueled rockets. Liquid helium is essential for many low temperature applications

Neon is a chemical element with symbol Ne and atomic number 10. It is in group 18 (noble gases) of the periodic table. Neon is a colorless, odorless, inert monatomic gas under standard conditions, with about two-thirds the density of air. It was discovered (along with krypton and xenon) in 1898. After discovery it was immediately recognized as a new element from its bright red emission spectrum. The name neon is derived from the Greek word,  $\nu\acute{\epsilon}\omicron\nu$ , neuter meaning new. Neon is chemically inert and forms no uncharged chemical compounds.

Argon is a chemical element with symbol Ar and atomic number 18. It is in group 18 of the periodic table and is a noble gas. Argon is the third most common gas in the Earth's atmosphere, at 0.93% (9,300 ppm), Nearly all of this argon is radiogenic argon-40 derived from the decay of potassium-40 in the Earth's crust. In the universe, argon-36 is by far the most common argon isotope.

Krypton (from Greek: κρυπτός kryptos "the hidden one") is a chemical element with symbol Kr and atomic number 36. It is a member of group 18 (noble gases) elements. A colorless, odorless, tasteless noble gas, krypton occurs in trace amounts in the atmosphere, is isolated by fractionally distilling liquified air, and is often used with other rare gases in fluorescent lamps. Krypton is inert for most practical purposes.

**Xenon** is a chemical element with the symbol **Xe** and atomic number 54. It is a colorless, heavy, odorless noble gas, which occurs in the Earth's atmosphere in trace amounts. Although generally unreactive, xenon can undergo a few chemical reactions such as the formation of xenon hexafluoroplatinate, the first noble gas compound to be synthesized.

Radon is a chemical element with symbol Rn and atomic number 86. It is a radioactive, colorless, odorless, tasteless noble gas, occurring naturally as an indirect decay product of uranium or thorium. Its most stable isotope,  $^{222}\text{Rn}$ , has a half-life of 3.8 days. Radon is one of the densest substances that remain a gas under normal conditions. It is also the only gas under normal conditions that only has radioactive isotopes, and is considered a health hazard due to its radioactivity. Intense radioactivity has also hindered chemical studies of radon and only a few compounds are known.

---

## 15.6 Review questions

---

1. What are noble gases discuss their positions in periodic table.
2. Give the synthesis, properties and uses of Helium.
3. explain the synthesis, properties and uses of Neon
4. Give the synthesis, properties and uses of Argon.
5. Give the synthesis, properties and uses of Krypton.

6. discuss the synthesis, properties and uses of Xenon.
- 

### **15.7 references and suggested readings**

---

1. Concise Inorganic chemistry- J.D. Lee (Blackwell Science) 2001
2. Inorganic Chemistry- F.A. Cotton (Interscience publisher) 2008
3. [Wikipedia.org](http://Wikipedia.org)
4. [Chemwiki.org](http://Chemwiki.org)

---

# Unit - 16 : Transition Metal Ions

---

## Structure of Unit:

- 16.0 Objectives
- 16.1 Introduction
- 16.2 Transition Metal Ion
- 16.3 Theorys of Coordination Compound
- 16.4 Metal Complex Ions
- 16.5 Structures of Coordination Compounds
- 16.6 Trans-effect
- 16.7 Bonding in transition metal compounds
- 16.8 Symmetric & Antisymmetric Wave Functions
- 16.9 Biological Importance of Coordination Complexes of Metal Ions
- 16.10 Summery
- 16.11 Review Question
- 16.13 Reference and Suggested readings

---

## 16.0 Objectives

---

At the end of the unit learner will be able to

- Familiar with transition metal compounds.
- Learn the biological Importance of Coordination Complexes of Metal Ions.
- Understand about Symmetric & Antisymmetric Wave Functions.
- Increase knowledge about Coordination Compounds.
- Familiar with Trans-effect.

---

## 16.1 Introduction

---

**This Chapter deals with increasing the knowledge of transition metal ions of complexes and its compound, and their knowledge about Bonding in transition metal compounds and as well as biological importance of coordination complexes of Metal Ions. And chapter also explain brief about Symmetric & Antisymmetric Wave Functions.**

---

## 16.2 Transition Metal Ion

---

The elements in the periodic table are often divided into four categories: (1) main group elements, (2) transition metals, (3) lanthanides, and (4) actinides. The main group elements include the active metals in the two columns on the extreme left of the periodic table and the metals, semimetals, and nonmetals in the six columns on the far right. The transition metals are the metallic elements that serve as a bridge, or transition, between the two sides of the table. The lanthanides and the actinides at the bottom of the table are sometimes known as the inner transition metals because they have atomic numbers that fall between the first and second elements in the last two rows of the transition metals.

### ➤ The Electron Configuration of Transition-Metal Ions

The relationship between the electron configurations of transition-metal elements and their ions is complex. Example: Let's consider the chemistry of cobalt which forms complexes that contain either  $\text{Co}^{2+}$  or  $\text{Co}^{3+}$  ions.

The electron configuration of a neutral cobalt atom is written as follows.

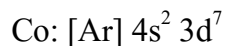

The discussion of the relative energies of the atomic orbitals suggests that the 4s orbital has a lower energy than the 3d orbitals. Thus, we might expect cobalt to

lose electrons from the higher energy 3d orbitals, but this is not what is observed. The  $\text{Co}^{2+}$  and  $\text{Co}^{3+}$  ions have the following electron configurations.



In general, electrons are removed from the valence-shell s orbitals before they are removed from valence d orbitals when transition metals are ionized.

Because the valence electrons in transition-metal ions are concentrated in d orbitals, these ions are often described as having dn configurations. The  $\text{Co}^{3+}$  and  $\text{Fe}^{2+}$  ions, for example, are said to have a d6 configuration.



### ➤ Oxidation States of the Transition Metals

	Sc	Ti	V	Cr	Mn	Fe	Co	Ni	Cu	Zn
+1									$d^{10}$	
+2			$d^3$		$d^5$	$d^6$	$d^7$	$d^8$	$d^9$	$d^{10}$
+3	$d^0$			$d^3$		$d^5$	$d^6$			
+4		$d^0$			$d^3$					
+5			$d^0$							
+6				$d^0$						
+7					$d^0$					



Most transition metals form more than one oxidation state. Some oxidation states, however, are more common than others. The most common oxidation states of the first series of transition metals are given in the table below. Efforts to explain the apparent pattern in this table ultimately fail for a combination of reasons. Some of these oxidation states are common because they are relatively stable. Others describe compounds that are not necessarily stable but which react slowly. Still others are common only from a historic perspective.

One point about the oxidation states of transition metals deserves particular attention: Transition-metal ions with charges larger than +3 cannot exist in aqueous solution.

Consider the following reaction in which manganese is oxidized from the +2 to the +7 oxidation state.



When the manganese atom is oxidized, it becomes more electronegative. In the +7 oxidation state, this atom is electronegative enough to react with water to form a covalent oxide,  $\text{MnO}_4$

It is useful to have a way of distinguishing between the charge on a transition-metal ion and the oxidation state of the transition metal. By convention, symbols such as  $\text{Mn}^{2+}$  refer to ions that carry a +2 charge. Symbols such as Mn(VII) are used to describe compounds in which manganese is in the +7 oxidation state. Mn(VII) is not the only example of an oxidation state powerful enough to decompose water. As soon as  $\text{Mn}^{2+}$  is oxidized to Mn(IV), it reacts with water to form  $\text{MnO}_2$ . A similar phenomenon can be seen in the chemistry of both vanadium and chromium. Vanadium exists in aqueous solutions as the  $\text{V}^{2+}$  ion. But once it is oxidized to the +4 or +5 oxidation state, it reacts with water to form the  $\text{VO}^{2+}$  or  $\text{VO}^{3+}$  ion. The  $\text{Cr}^{3+}$  ion can be found in aqueous solution. But once this ion is oxidized to Cr(VI), it reacts with water to form the  $\text{CrO}_4^{2-}$  and  $\text{Cr}_2\text{O}_7^{2-}$  ions.

---

## 16.3 Theories of Coordination Compound

---

-Werner Coordination Theory

-Valence Bond Theory

-Crystal field theory

### 1. Werner's Theory of Coordination Complexes

Alfred Werner developed a model of coordination complexes which explains the following observations. At least three different cobalt(III) complexes can be isolated when  $\text{CoCl}_2$  is dissolved in aqueous ammonia and then oxidized by air to the +3 oxidation state. A fourth complex can be made by slightly different techniques. These complexes have different colors and different empirical formulas.

$\text{CoCl}_3 \cdot 6\text{NH}_3$       orange-yellow

$\text{CoCl}_3 \cdot 5\text{NH}_3 \cdot \text{H}_2\text{O}$    red

$\text{CoCl}_3 \cdot 5\text{NH}_3$       purple

$\text{CoCl}_3 \cdot 4\text{NH}_3$       green

The reactivity of the ammonia in these complexes has been drastically reduced. By itself, ammonia reacts rapidly with hydrochloric acid to form ammonium chloride.

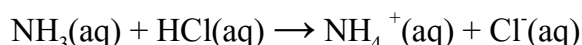

These complexes don't react with hydrochloric acid, even at 100°C.

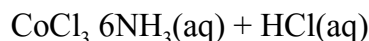

Solutions of the  $\text{Cl}^-$  ion react with  $\text{Ag}^+$  ion to form a white precipitate of  $\text{AgCl}$ .

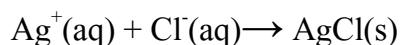

When excess  $\text{Ag}^+$  ion is added to solutions of the  $\text{CoCl}_3 \cdot 6\text{NH}_3$  and  $\text{CoCl}_3 \cdot 5\text{NH}_3 \cdot \text{H}_2\text{O}$  complexes, three moles of  $\text{AgCl}$  are formed for each mole of complex in solution, as might be expected. However, only two of the  $\text{Cl}^-$  ions in the  $\text{CoCl}_3 \cdot 5\text{NH}_3$  complex and only one of the  $\text{Cl}^-$  ions in  $\text{CoCl}_3 \cdot 4\text{NH}_3$  can be precipitated with

Ag<sup>+</sup> ions. Measurements of the conductivity of aqueous solutions of these complexes suggest that the CoCl<sub>3</sub>·6NH<sub>3</sub> and CoCl<sub>3</sub>·5NH<sub>3</sub>·H<sub>2</sub>O complexes dissociate in water to give a total of four ions. CoCl<sub>3</sub>·5NH<sub>3</sub> dissociates to give three ions, and CoCl<sub>3</sub>·4NH<sub>3</sub> dissociates to give only two ions. Werner explained these observations by suggesting that transition-metal ions such as the Co<sup>3+</sup> ion have a primary valence and a secondary valence. The primary valence is the number of negative ions needed to satisfy the charge on the metal ion. In each of the cobalt(III) complexes previously described, three Cl<sup>-</sup> ions are needed to satisfy the primary valence of the Co<sup>3+</sup> ion. The secondary valence is the number of ions or molecules that are coordinated to the metal ion. Werner assumed that the secondary valence of the transition metal in these cobalt(III) complexes is six. The formulas of these compounds can therefore be written as follows.

$[\text{Co}(\text{NH}_3)_6]^{3+}[\text{Cl}^-]_3$	orange-yellow
$[\text{Co}(\text{NH}_3)_5(\text{H}_2\text{O})]^{3+}[\text{Cl}^-]_3$	red
$[\text{Co}(\text{NH}_3)_5\text{Cl}]^{2+}[\text{Cl}^-]_2$	purple
$[\text{Co}(\text{NH}_3)_4\text{Cl}_2]^{2+}[\text{Cl}^-]$	green

The cobalt ion is coordinated to a total of six ligands in each complex, which satisfies the secondary valence of this ion. Each complex also has a total of three chloride ions that satisfy the primary valence. Some of the Cl<sup>-</sup> ions are free to dissociate when the complex dissolves in water. Others are bound to the Co<sup>3+</sup> ion and neither dissociate nor react with Ag<sup>+</sup>.

The [Co(NH<sub>3</sub>)<sub>6</sub>]Cl<sub>3</sub> complex dissociates in water to give a total of four ions, and all three Cl<sup>-</sup> ions are free to react with Ag<sup>+</sup> ion.

H<sub>2</sub>O



One of the chloride ions is bound to the cobalt in the [Co(NH<sub>3</sub>)<sub>5</sub>Cl]Cl<sub>2</sub> complex. Only three ions are formed when this compound dissolves in water, and only two Cl<sup>-</sup> ions are free to precipitate with Ag<sup>+</sup> ions.

H<sub>2</sub>O



Once again, the three Cl<sup>-</sup> ions are free to dissociate when [Co(NH<sub>3</sub>)<sub>5</sub>(H<sub>2</sub>O)]Cl<sub>3</sub> dissolves in water, and they precipitate when Ag<sup>+</sup> ions are added to the solution.

H<sub>2</sub>O



Two of the chloride ions are bound to the cobalt in [Co(NH<sub>3</sub>)<sub>4</sub>Cl<sub>2</sub>]. Only two ions are formed when this compound dissolves in water, and only one Cl<sup>-</sup> ion is free to precipitate with Ag<sup>+</sup> ions.

H<sub>2</sub>O

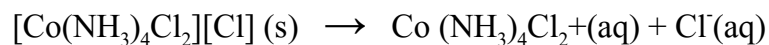

Werner assumed that transition-metal complexes had definite shapes. According to his theory, the ligands in six-coordinate cobalt(III) complexes are oriented toward the corners of an octahedron, as shown in the figure below.

## 2. The valence bond (VB) theory

The valence-bond approach considers the overlap of the atomic orbitals (AO) of the participation atoms to form a chemical bond. Due to the overlapping, electrons are localized in the bond region. The overlapping AOs can be of different types, for example, a sigma bond may be formed by the overlapping the following AOs.

### Chemical bonds formed due to overlap of atomic orbitals

<i>s-s</i>	<i>s-p</i>	<i>s-d</i>	<i>p-p</i>	<i>p-d</i>	<i>d-d</i>
H-H	H-C	H-Pd in	C-C	F-S	Fe-Fe
LI-H	H-N	palladium		P-P	in SF <sub>6</sub>
	H-F	hydride	S-S		

However, the atomic orbitals for bonding may not be "pure" atomic orbitals directly from the solution of the Schrodinger Equation. Often, the bonding atomic orbitals have a character of several possible types of orbitals. The methods to get an AO with the proper character for the bonding are called hybridization. The

resulting atomic orbitals are called hybridized atomic orbitals or simply hybrid orbitals.

### 3. Crystal Field Theory

Crystal field theory describes bonding in transition metal complexes. the formation of a complex is a Lewis acid-base reaction. Both electrons in the bond come from the ligand and are donated into an empty, hybridized orbital on the metal. charge is donated from the ligand to the metal. Assumption in crystal field theory: the interaction between ligand and metal is electrostatic. There are differences in the electrostatic interactions depending on the ligand.

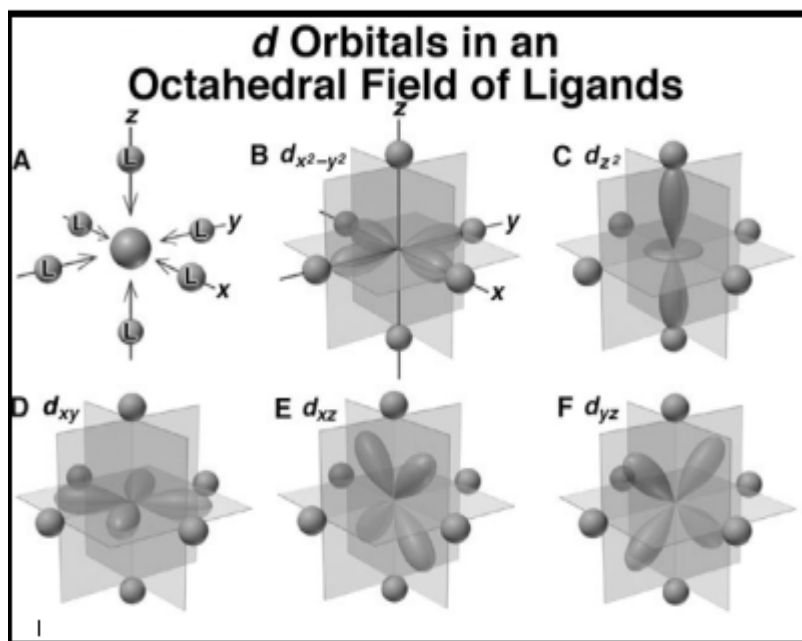

The complex metal ion has a lower energy than the separated metal and ligands. In an octahedral field, the five d orbitals do not have the same energy: Two orbitals are higher energy than the other three orbitals. The energy gap between them is called  $\Delta$ , the crystal field splitting energy.

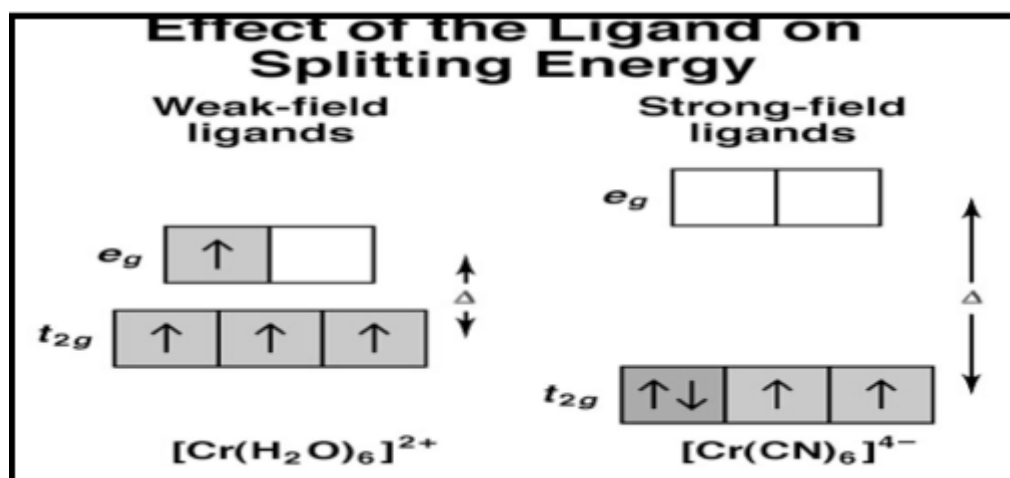
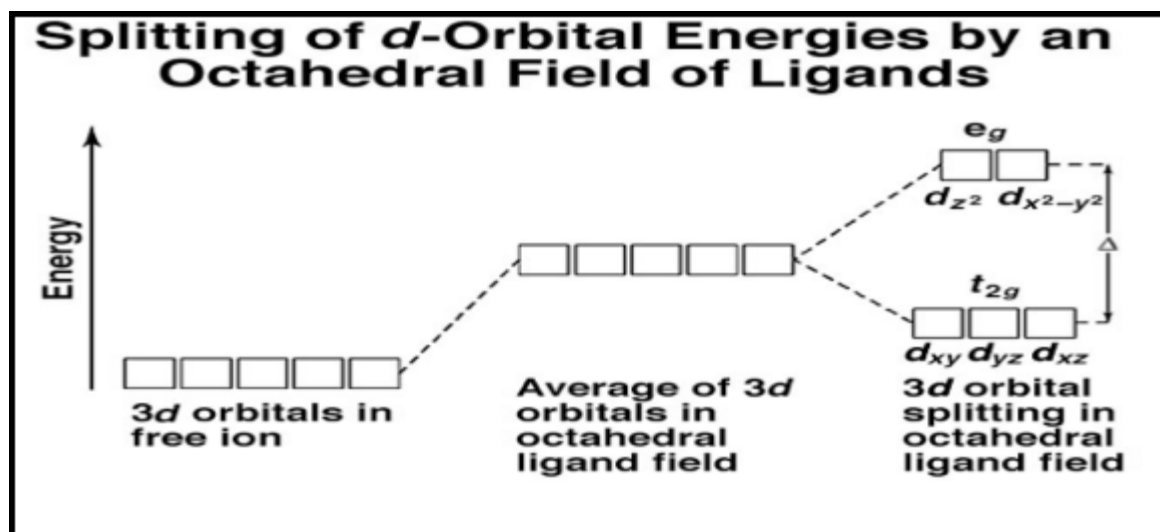

## Electronic Configurations of Transition Metal Complexes

$d$  orbital occupancy depends on  $\Delta$  (ligand(s)) and pairing energy,  $P$

- $e^-$ 's assume the electron configuration with the lowest possible energy cost
- If  $\Delta > P$  ( $\Delta$  large; strong field ligand)
- $e^-$ 's pair up in lower energy  $d$  sub shell first
- If  $\Delta < P$  ( $\Delta$  small; weak field ligand)
- $e^-$ 's spread out among all  $d$  orbitals before any pair up

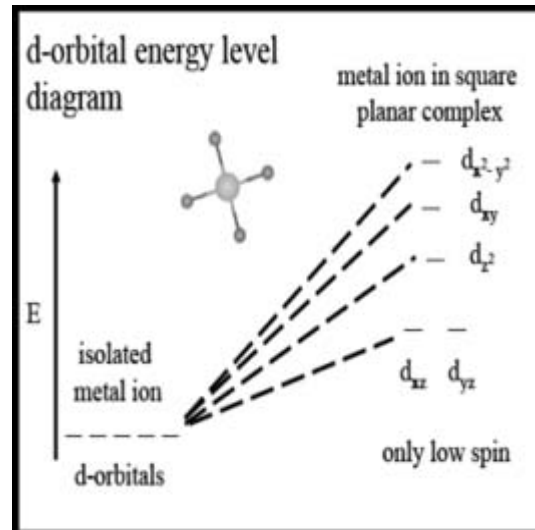
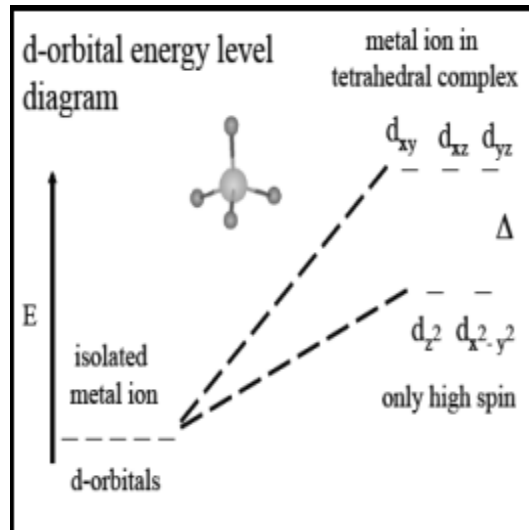

## 16.4 Metal Complex Ions

A complex ion has a metal ion at its centre with a number of other molecules or ions surrounding it. These can be considered to be attached to the central ion by co-ordinate (dative covalent) bonds.

A covalent bond is formed by two atoms sharing a pair of electrons. The atoms are held together because the electron pair is attracted by both of the nuclei. In the formation of a simple covalent bond, each atom supplies one electron to the bond - but that doesn't have to be the case. A co-ordinate bond (also called a dative covalent bond) is a covalent bond (a shared pair of electrons) in which both electrons come from the same atom.

The metal is known as the central metal ion. The anions or molecules attached to the metal are called ligands. The coordination number is the number of places on the metal ion where ligands are bound. The bond between the metal ion and the ligand, where the ligand supplies both electrons, is known as a coordinate covalent bond. Simple ligands include water, ammonia and chloride ions.

All ligands are lone pair donors. In other words, all ligands function as Lewis bases.

➤ **Bonding in simple complex ions**

**Example of  $\text{Al}(\text{H}_2\text{O})_6^{3+}$**

We are going to look in detail at the bonding in the complex ion formed when water molecules attach themselves to an aluminium ion to give  $\text{Al}(\text{H}_2\text{O})_6^{3+}$ . Start by thinking about the structure of a naked aluminium ion before the water molecules bond to it. Aluminium has the electronic structure

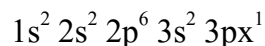

When it forms an  $\text{Al}^{3+}$  ion it loses the  $n=3$  electrons:

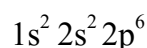

That means that all the 3-level orbitals are now empty. The aluminium uses six of these to accept lone pairs from six water molecules. It re-organises (hybridises) the 3s, the three 3p, and two of the 3d orbitals to produce six new orbitals all with the same energy. You might wonder why it chooses to use six orbitals rather than four or eight or whatever. Six is the maximum number of water molecules it is possible to fit around an aluminium ion (and most other metal ions). By making the maximum number of bonds, it releases most energy and so becomes most energetically stable.

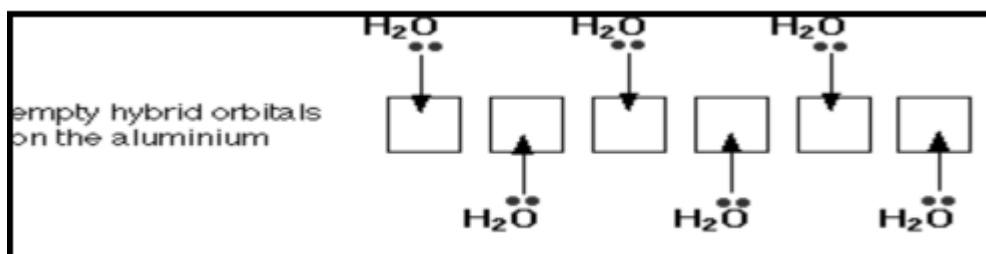

Only one lone pair is shown on each water molecule. The other lone pair is pointing away from the aluminium and so isn't involved in the bonding. The resulting ion looks like this:

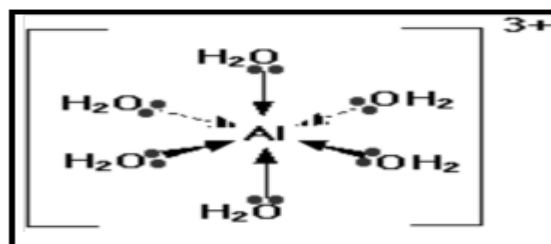



Because of the movement of electrons towards the centre of the ion, the 3+ charge is no longer located entirely on the aluminium, but is now spread over the whole of the ion. Because the aluminium is forming 6 bonds, the co-ordination number of the aluminium is said to be 6. The co-ordination number of a complex ion counts the number of co-ordinate bonds being formed by the metal ion at its centre.

In a simple case like this, that obviously also counts the number of ligands - but that isn't necessarily so, as you will see later. Some ligands can form more than one co-ordinate bond with the metal ion.

### Example of $\text{Fe}(\text{H}_2\text{O})_6^{3+}$

Iron has the electronic structure

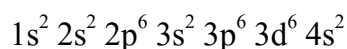

When it forms an  $\text{Fe}^{3+}$  ion it loses the 4s electrons and one of the 3d electrons

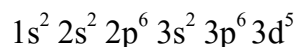

The orbital diagram looks like: Now,

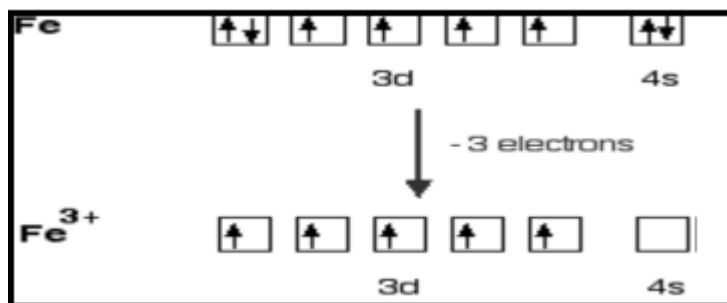

Now, be careful! The single electrons in the 3d level are NOT involved in the bonding in any way. Instead, the ion uses 6 orbitals from the 4s, 4p and 4d levels to accept lone pairs from the water molecules. Before they are used, the orbitals are re-organised (hybridised) to produce 6 orbitals of equal energy.

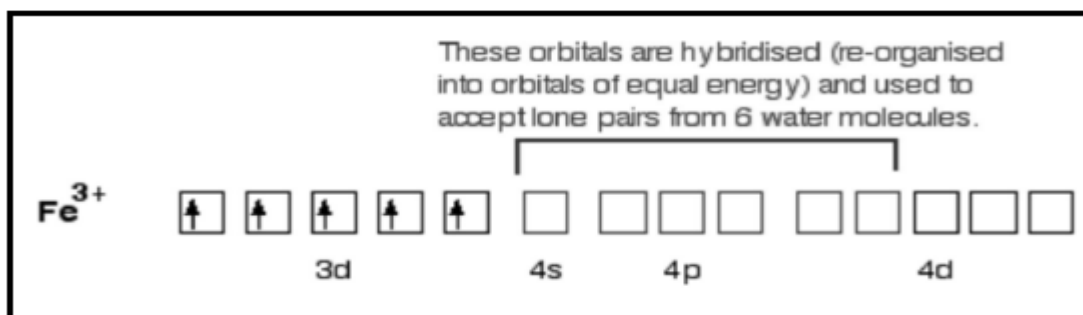

Once the co-ordinate bonds have been formed, the ion looks exactly the same as the equivalent aluminium ion.

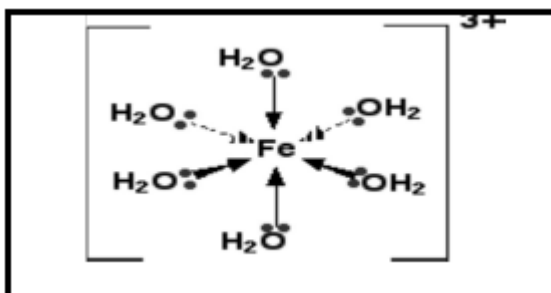

Because the iron is forming 6 bonds, the co-ordination number of the iron is 6.

### Example of $\text{CuCl}_4^{2-}$

This is a simple example of the formation of a complex ion with a negative charge. Copper has the electronic structure

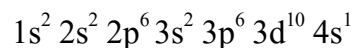

When it forms a  $\text{Cu}^{2+}$  ion it loses the 4s electron and one of the 3d electrons

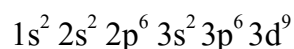

To bond the four chloride ions as ligands, the empty 4s and 4p orbitals are used (in a hybridised form) to accept a lone pair of electrons from each chloride ion. Because chloride ions are bigger than water molecules, you can't fit 6 of them around the central ion - that's why you only use 4.

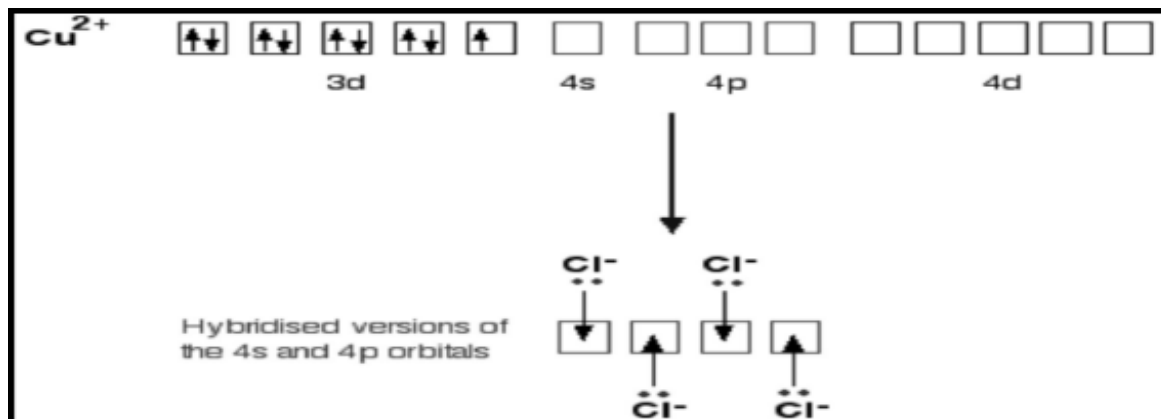

Only one of the 4 lone pairs on each chloride ion is shown. The other three are pointing away from the copper ion, and aren't involved in the bonding. That gives you the complex ion:

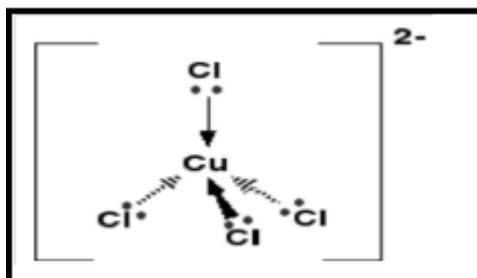

The ion carries 2 negative charges overall. That comes from a combination of the 2 positive charges on the copper ion and the 4 negative charges from the 4 chloride ions. In this case, the co-ordination number of the copper is, of course, 4.

---

## 16.5 Structures of Coordination Compounds

---

Coordination compounds are also known as coordination complexes, complex compounds, or simply complexes. The essential feature of coordination compounds is that coordinate bonds form between electron pair donors, known as the *ligands*, and electron pair acceptors, the metal atoms or ions. The number of electron pairs donated to the metal is known as its *coordination number*. Although many complexes exist in which the coordination numbers are 3, 5, 7, or 8, the majority of complexes exhibit coordination numbers of 2, 4, or 6.

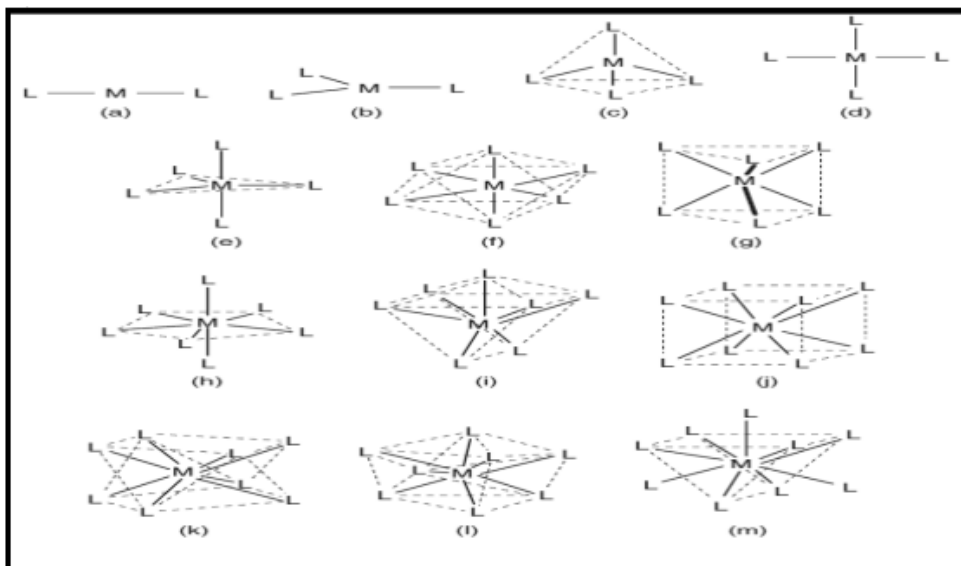

In order for a pair of electrons to be donated from a ligand to a metal ion, there must be an *empty* orbital on the metal ion to accept the pair of electrons. This situation is quite different from that where covalent bonds are being formed because in that case, one electron in a bonding pair comes from each of the atoms held by the bond. One of the first factors to be described in connection with the formation of coordinate bonds is that of seeing what type(s) of orbitals are available on the metal. If the metal ion is  $Zn^{2-}$ , the electron configuration is  $3d^{10}$ . Therefore, the  $4s$  and  $4p$  orbitals are empty and can be hybridized to give a set of four empty  $sp^3$  hybrid orbitals. This set of hybrid orbitals could accommodate four pairs of electrons donated by ligands with the bonds pointing toward the corners of a tetrahedron. Accordingly, it should be expected that  $[Zn(NH_3)_4]^{2-}$  would be tetrahedral, and that is correct. As will be shown later, there are many complexes that have coordination numbers of 2 (linear complexes such as  $[Ag(NH_3)_2]^+$ ), 4 (tetrahedral complexes such as  $[CoCl_4]^{2-}$  or square planar complexes such as  $[Pt(NH_3)_4]^{2+}$ ) or 6 (octahedral complexes such as  $[Co(NH_3)_6]^{3+}$ ). A considerably smaller number of complexes having coordination numbers of 3 (trigonal planar), 5 (trigonal bipyramid or squarebased pyramid), 7 (pentagonal bipyramid or capped trigonal prism), or 8 (cubic or antiprismatic, which is also known as Archimedes antiprism) are also known. These structures are shown in below Figure

In a tetrahedral structure, all of the positions around the central atom are equivalent, so there is no possibility of geometrical or *cis/trans* isomerism. If all four groups bonded to the metal are different, there can be optical isomers. A compound such as  $[\text{Pd}(\text{NH}_3)_2\text{Cl}_2]$  would exist in only one isomer if the compound were tetrahedral. However, two isomers of the compound exist because the bonding around the metal is square planar.

Alfred Werner isolated these two isomers, which showed conclusively that the complex is square planar rather than tetrahedral. The *cis* isomer is now known by the trade name cisplatinol or cisplatin, and it is used in treating certain forms of

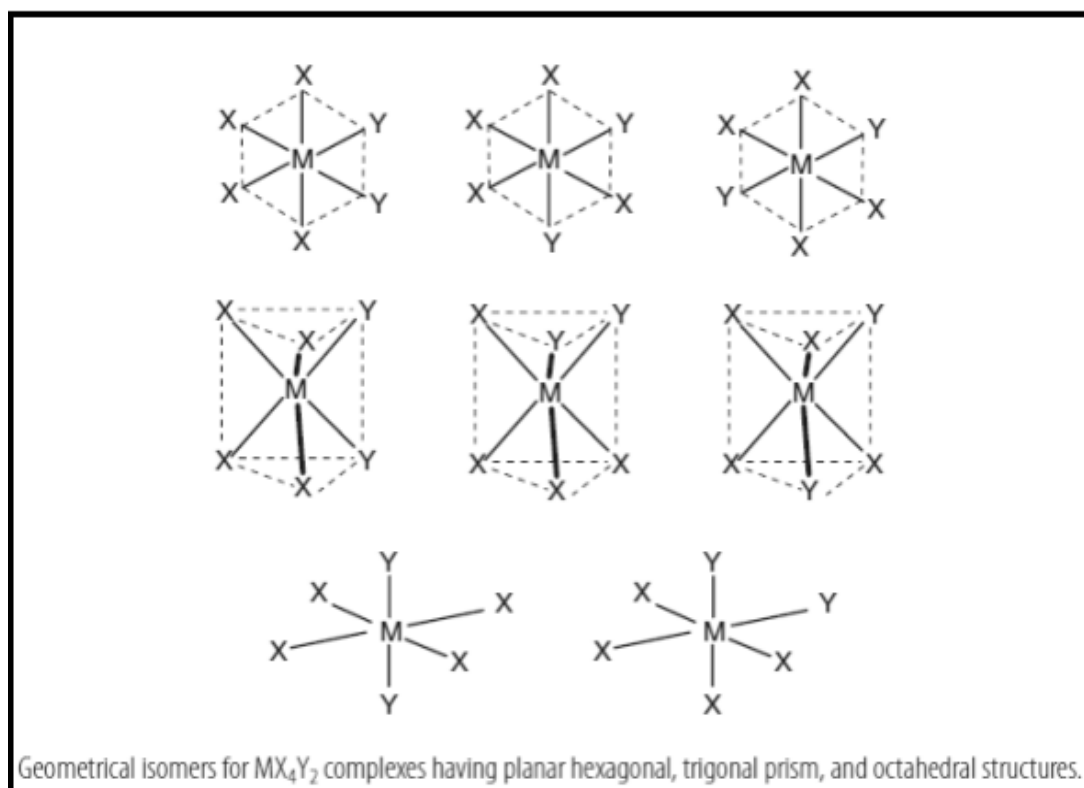

cancer. If a complex has a coordination number of 6, there are several ways to place

the ligands around the metal. A completely random arrangement is not expected because chemical bonds do not ordinarily form that way. Three regular types of geometry are possible for a complex containing six ligands. The six groups could

be arranged in a planar hexagon (analogous to benzene) or the ligands could be arranged around the metal in a trigonal prism or in an octahedral structure. For a complex having the formula  $MX_4Y_2$ , these arrangements lead to different numbers of isomers as shown in below Figure. the coordinate bonds are the result of Lewis acid-base interactions, the number of species that can form complexes with metal ions is large. Lewis bases such as  $H_2O$ ,  $NH_3$ ,  $F^-$ ,  $Cl^-$ ,  $Br^-$ ,  $I^-$ ,  $CN^-$ ,  $SCN^-$ , and  $NO_2^-$  all form a wide range of coordination compounds. Added to these are compounds such as amines, arsines, phosphines, and carboxylic acids that are all potential ligands. The ethylenediamine molecule,  $H_2NCH_2CH_2NH_2$ , is a ligand that forms many very stable complexes because each nitrogen atom has an unshared pair of electrons that can be donated to a metal ion. This results in the ethylenediamine molecule being attached to the metal ion at two sites, giving a ring with the metal ion being one of the members. A ring of this type is known as a chelate (pronounced “ key-late ” ) ring (from the Greek word *chelos*, meaning “ claw ” ). A complex that contains one or more chelate rings is called a chelate complex or simply a chelate.

## 16.6 Trans-effect

The trans effect and trans-influence help to rationalise the stability and substitution chemistry of transition metal complexes, particularly square planar Pd and Pt complexes. the trans effect is a kinetic phenomenon and describes the influence of a non-labile group on the rate of substitution of a ligand trans to it.

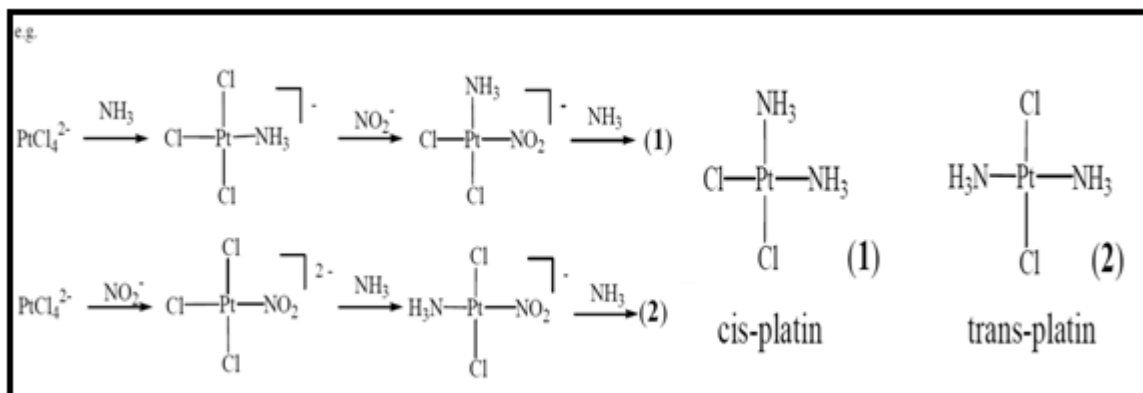
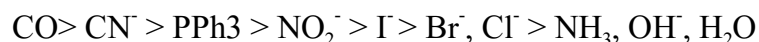

---

## 16.7 Bonding in transition metal compounds

---

### ❖ Metal-Metal Bonding

$\delta$ -bonds are generally weaker than  $\sigma$ -bonds due to poor overlap between precursor orbitals. M-M bonding energy increases down a group which is in contrast to the p-block.

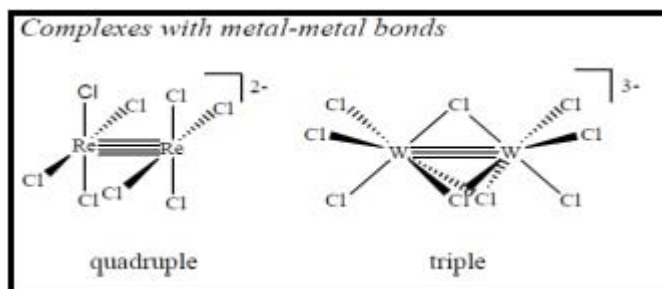

Note: Bond order in complexes is usually less than 5 because metal orbitals are required for the ML bonds.

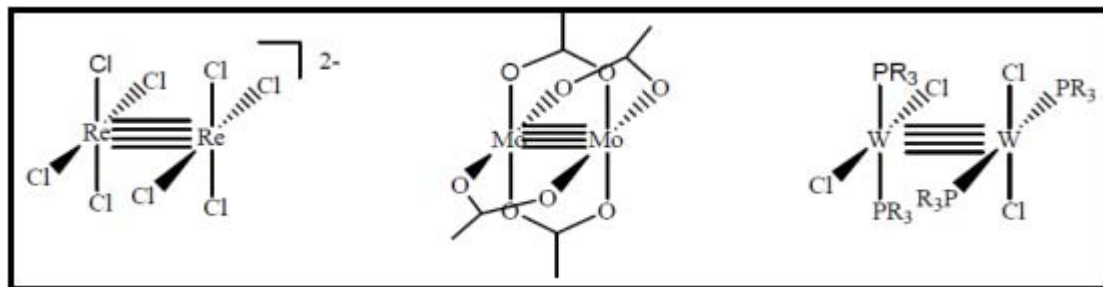

### ❖ Quadruple bonds

There is a competition between metal-metal and metal-ligand bonding. One orbital can't (usually) do both, so if it's involved in metal-ligand bonding, it's effectively 'factored out' of the metal-metal bond.

## ❖ Triple bonds

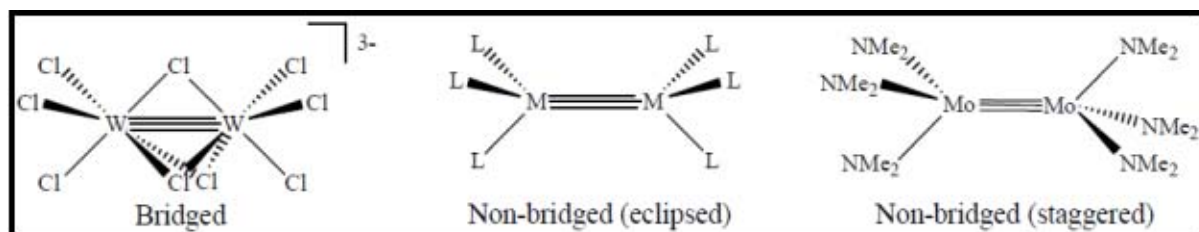

## Quintuple Bonds

Very recently the concept of metal-metal multiple bonds was extended by the synthesis of the Cr(I) complex shown below. The Cr-Cr distance is 184 pm, which is very short and indicative of significant multiple bonding.

Remember that the metal has 9 valence orbitals. What if the ligands formed bonds with the *s* or *p* orbitals and not just the *d*-orbitals? The *s*-orbitals are closer in energy to the *d* and ligand based orbitals and may be available for bonding. The *p*-orbitals are too high.

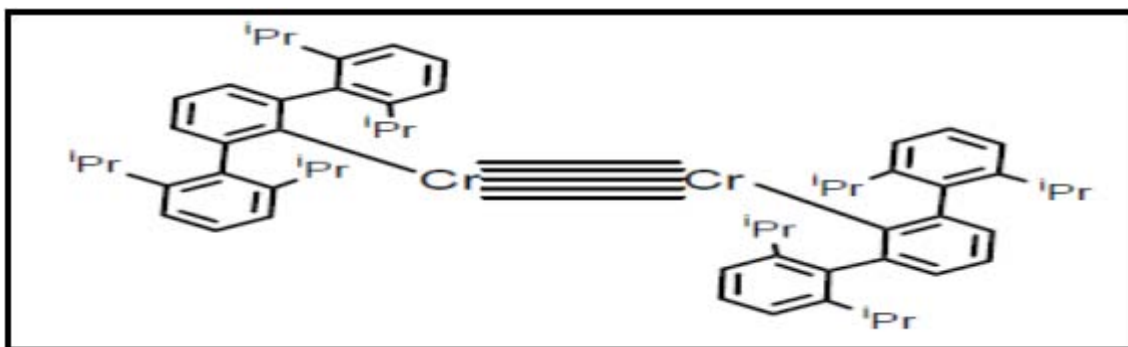

Simplistically, the ligand forms a bond with the Cr 4s orbitals leaving the 5 d-orbitals available for Cr-Cr bonding. The real situation is more complicated, because of orbital mixing, which also results in a trans-bent geometry and not linear, which would be expected for a pure quintuple bond.



---

## 16.8 Symmetric & Antisymmetric Wave Functions

---

### ➤ One electron wave functions

In order to specify the wave function of a single electron we need to specify the five quantum

Numbers

1.  $n$  – Principal Quantum Number
2.  $\ell$  – Orbital Quantum Number
3.  $m\ell$  – Magnetic Quantum Number, the projection of  $\ell$  on the z axis
4.  $s$  – Spin, always equal to  $\frac{1}{2}$ .
5.  $m_s$  – projection of  $s$  on the z axis

The first three quantum numbers define the spatial part of the wave function  $\Psi(n\ell m\ell)$ , the solution to Schroedinger's Equation. The last two quantum numbers define the spin part of the wave function, although since the spin is always equal to  $\frac{1}{2}$  it is sufficient to specify only its projection on the z axis,  $m_s$ . The projection can only take on one of two values  $+\frac{1}{2}$  (spin up) and  $-\frac{1}{2}$  (spin down). The spin portion of the wave function has two forms  $\sigma(\uparrow)$  and  $\sigma(\downarrow)$ . The total wave function for the electron is the product of the spatial part and the spin part

$$\Psi(n\ell m\ell m_s) = \Psi(n\ell m\ell) \sigma(m_s)$$

### ➤ Two electron wave functions

The wave function for two electrons is a combination of two one electron wave functions.

However, we have to take into account two properties of electrons.

- the electrons in an atom are indistinguishable. If we have two electrons, which we shall arbitrarily label as A and B, and a  $n\ell n'\ell'$  configuration then

we should have no way of telling which electron is the  $n\ell$  electron and which is the  $n'\ell'$  electron.

- The electrons are fermions<sup>1</sup>. Fermions cannot have the same set of quantum numbers, and must have antisymmetric wave functions. If the labels a and b on the electrons are exchanged then the new wave function must be the same as the original wave function, except for a negative sign.

$$\Psi(A,B) = -\Psi(B,A)$$

If  $n=n'$  and  $\ell=\ell'$  then the electrons are said to be equivalent. For these electrons the Pauli Exclusion Principle restricts the number of wave functions that can be produced. However if either  $n \neq n'$  or  $\ell \neq \ell'$  then the Pauli Exclusion Principle is already satisfied and the full set of wave functions is produced. We shall look at the two cases separately.

➤ **Non-equivalent electrons**

- multiply a symmetric spatial wave function with an antisymmetric spin wave function multiply an antisymmetric spatial wave function with a symmetric spin wave function. If we try writing the spatial wave function as the product of two one electron spatial wave Functions

$$\Psi(n\ell n'\ell') = \Psi_A(n\ell) \Psi_B(n'\ell')$$

the result is not acceptable, it tells us which electron is the  $n\ell$  electron and which is the  $n'\ell'$  electron. However, linear combinations of this trial form solves the problem.

- $\Psi_A(n\ell) \Psi_B(n'\ell') + \Psi_B(n\ell) \Psi_A(n'\ell')$  is symmetric. If the labels A and B are switched then the new wave function is the same as the old wave function.
- Similarly,  $\Psi_A(n\ell) \Psi_B(n'\ell') - \Psi_B(n\ell) \Psi_A(n'\ell')$  is antisymmetric.

(It is common to re-normalize the wave function by dividing by a factor of  $\sqrt{2}$  in each of the above expressions. However, this does not affect the argument here, and we shall not include this factor.)

Now turn to the spin wave functions. If both electrons are in the same spin state (either both spin up or both spin down) then we can write two possible two electron spin wave functions

1.  $\sigma_A(\uparrow) \sigma_B(\uparrow)$

2.  $\sigma_A(\downarrow) \sigma_B(\downarrow)$

both of which are symmetric. However, if they are in opposite spin states (one spin up and the other spin down) then a spin wave function of the form  $\sigma_A(\uparrow)\sigma_B(\downarrow)$  is not acceptable, we would know that electron A is the spin up electron and B is the spin down electron. As was the case with the spatial wave functions we will get round the problem by writing linear combinations.

3.  $\sigma_A(\uparrow) \sigma_B(\downarrow) + \sigma_B(\uparrow) \sigma_A(\downarrow)$ , which is symmetric

4.  $\sigma_A(\uparrow) \sigma_B(\downarrow) - \sigma_B(\uparrow) \sigma_A(\downarrow)$ , which is antisymmetric

Of the four possible acceptable spin wave functions, three are symmetric and one is antisymmetric. The antisymmetric one must have one spin up electron and one spin down electron, such that  $M_S = m_{sA} + m_{sB} = 0$ . This can only correspond to an atom with  $S = 0$ , a singlet state. On the other hand, the three symmetric spin wave functions can have both electrons spin up ( $M_S = 1$ ), one spin up and the other spin down ( $M_S = 0$ ), or both spin down ( $M_S = -1$ ). With these three values of  $M_S$  the total spin is  $S = 1$ , and we have a triplet state.

### ➤ The excited configurations of helium

The ground configuration of helium is  $1s^2$ , that is two equivalent electrons (see below). The excited configurations are formed by promoting one of these electrons to form the  $1s n\ell$  configuration. Each one of these configurations can form two terms, with  $L = \ell$ , and  $S = 0$  or  $1$

- $1s2s \rightarrow 1S$  and  $3S$
- $1s2p \rightarrow 1P$  and  $3P$
- $1s3s \rightarrow 1S$  and  $3S$
- $1s3p \rightarrow 1P$  and  $3P$
- $1s3d \rightarrow 1D$  and  $3D$

---

## 16.9 Biological Importance of Coordination Complexes of Metal Ions

---

First-Row Transition Metal	Biological Function(s)
Scandium	None known
Titanium	None known
Vanadium	None known in humans
Chromium	Assists insulin in the control of blood sugar; may also be involved in the control of cholesterol
Manganese	Necessary for a number of enzymatic reactions
Iron	Component of hemoglobin and myoglobin; involved in the electron transport chain
Cobalt	Component of vitamin B <sub>12</sub> , which is essential for the metabolism of carbohydrates, fats, and proteins
Nickel	Component of the enzymes urease and hydrogenase
Copper	Component of several enzymes; assists in iron storage; involved in the production of color pigments of hair, skin, and eyes
Zinc	Component of insulin and many enzymes

Vanadium     None known in humans

Chromium     Assists insulin in the control of blood sugar; may also be involved in the control of cholesterol

Manganese	Necessary for a number of enzymatic reactions
Iron	Component of hemoglobin and myoglobin; involved in the electron transport chain
Cobalt	Component of vitamin B <sub>12</sub> , which is essential for the metabolism of carbohydrates, fats, and proteins
Nickel	Component of the enzymes urease and hydrogenase
Copper	Component of several enzymes; assists in iron storage; involved in the production of color pigments of hair, skin, and eyes
Zinc	Component of insulin and many enzymes

---

## 16.10 Summary

---

This Chapter increase the knowledge of transition metal compounds and Coordination Compounds and their knowledge about Bonding in transition metal compounds and as well as biological importance of coordination complexes of metal ions. Chapter also explain brief about Structures of Coordination Compounds.

---

## 16.11 Review Question

---

1. Define transition metal compounds?
2. What are biological Importance of Coordination Complexes of Metal Ions?
3. Define the werner's theory of coordination complexes?
4. Define trans-effect?
5. Explain Symmetric & Antisymmetric Wave Functions?

---

## 16.12 Reference and Suggested readings

---

1. Inorganic Chemistry James E. House ISBN: 978-0-12-356786-4
2. *Introduction to Modern Physics*, 6th ed., by Richtmeyer, Kennard, and Cooper, pages 452 to 455
3. [www.science.uwaterloo.ca/~cchieh/cact/c120/hybrid.htm](http://www.science.uwaterloo.ca/~cchieh/cact/c120/hybrid.htm)

---

## Unit-17 : Concepts and Scope of ligand field

---

### Structure of Unit:

- 17.0 Objective
- 17.1 Introduction
- 17.2 Effect of ligand field on energy levels of transition metal ions
- 17.3 Octahedral complexes:
- 17.4 Strong and weak ligands
- 17.5 High and low spin complexes
- 17.6 Angular description
- 17.7 Introduction of the spectra of transition metal complexes
  - 17.7.1 Orbital angular momentum of electron
  - 17.7.2 Effect of field on the angular momentum vectors
  - 17.7.3 Angular momentum comparing of single electron
  - 17.7.4 Stable configuration
- 17.8. Orbital angular momentum coupling (l)-(l) coupling
  - 17.8.1 Orbital and spin coupling of single electron (l) – (s) coupling
  - 17.8.2. Energy Terms
  - 17.8.3. Energy States
  - 17.8.4. (L) – (S) Russel – saunders coupling scheme
- 17.9. Effect of weak octahedral crystal field potential ( $v_{\text{oct}}$ ) and weak tetrahedral crystal field potential  $v_{\text{tet}}$  on terms
  - 17.9.1. Electrostatic repulsive interrelations
  - 17.9.2.(a) Effect of weak  $v_{\text{oct}}$  or  $v_{\text{tet}}$  on s term
  - 17.9.3.(b) Effect of weak  $v_{\text{oct}}$  or  $v_{\text{tet}}$  on p term

17.9.4.(c) Effect of weak  $v_{\text{oct}}$  and  $v_{\text{tet}}$  on D term

17.9.5. Splitting of F term under weak  $V_{\text{oct}}$  weak  $V_{\text{tet}}$

17.10 Correlation diagram ORGEL diagram

17.11. Strong field effect Tanabe-sugano diagram

17.11.1. Left part of T.S. diagram

17.12 Spin pairing energies

17.13. Summary

17.14. Questions

17.15 References:

---

## 17.0 Objective

---

The topic main objective is to understand the concept of CFSE which is helpful in understanding the spectra of the transition metals in the tetrahedral and the octahedral complexes. The use of Orgel diagram and the Tanabe Sugano diagram to predict the spectra in the strong and the weak ligand field

---

## 17.1 Introduction

---

The concept of L-L and s-s coupling which is the result of interelectronic repulsive interaction give rise to energy terms which get splitted into various spectroscopic states as the result of the L-S coupling and spectra of the transition metal complexes can be explained by transition between these energy states, the Orgel diagram which helps in the prediction of the spectra in the weak field and the Tanabe Sugano diagrams predicting the spectra in the strong field also, shall be dealt in this unit.

---

## 17.2 Effect of ligand field on energy levels of transition metal ions

---

For an isolated gaseous metal (transition) ion five d-orbitals are degenerate and are of same energies in presence of spherically symmetrical field.



In presence of ligand field (either four ligands in tetrahedral structure or six ligands in octahedral structures) the degeneracy of d-orbitals are ruptured.

---

### 17.3 Octahedral complexes:

---

For the octahedral complexes the ligand surrounds the metal ion of the transition metal complexes from the six direction which are the negative and the positive axis of the Cartesian coordinate system, shown in the fig.1. the ligands are attracted towards the metal ion due to its positive charge but get repelled when approaches more close to the metal because of the repulsive interaction between the the metal orbitals and the ligand electronic environment, ligand can be negatively charged or neutral.

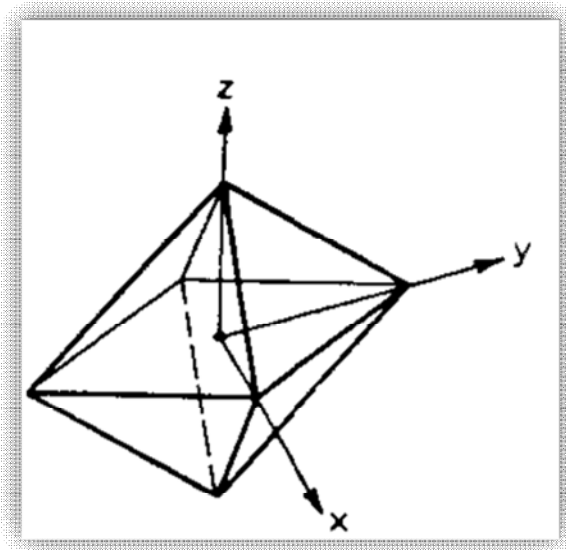

Figure-1 The directions in an octahedral complex

Ligands all at the six corners of octahedral complex (fig.1) i.e. at x, y, z, -x, -y, -z direction as a result the axial d-orbital ( $d_{x^2-y^2}$  &  $d_z^2$ ) suffers more repulsion than planar d-orbitals ( $d_{xy}$ ,  $d_{yz}$ ,  $d_{zx}$ ) from the approaching ligands hence making axial orbitals to have more energy, than planar orbitals due to inter-electronic repulsive interaction as shown in the fig.2

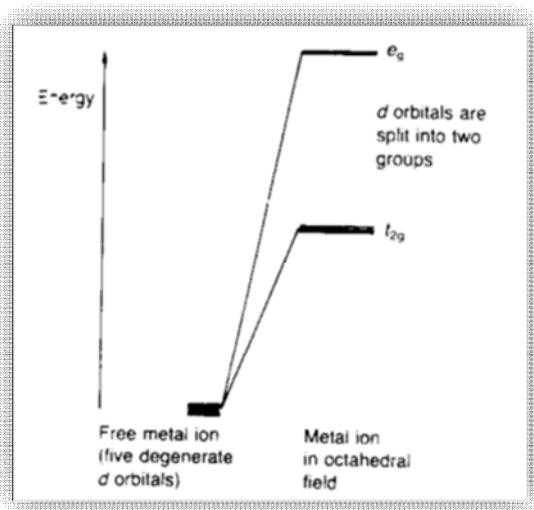

Figure-2 Crystal field splitting of every level in octahedral field

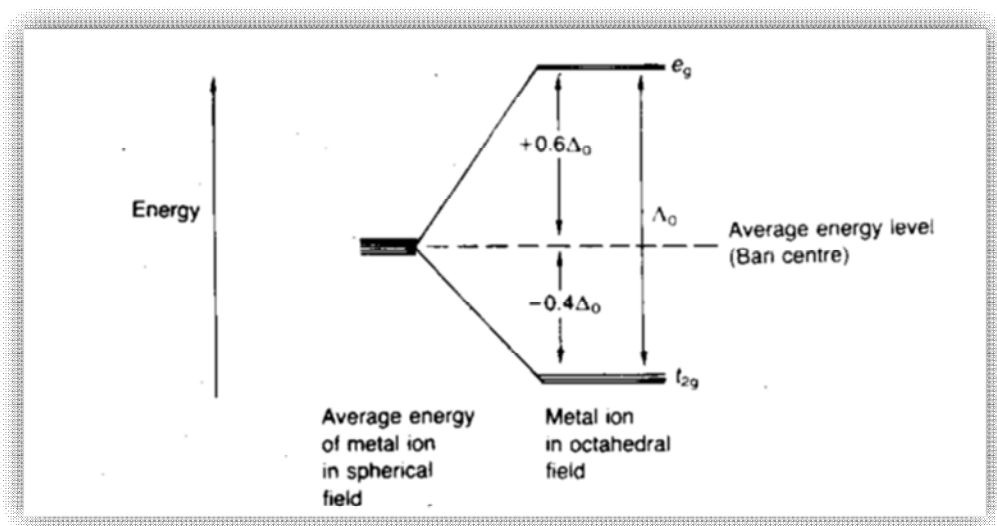

Figure-3 Diagram of the energy levels of d-orbitals in an octahedral field

The difference in the energy levels of the splitted degenerate d-orbitals is called as Crystal field energy  $\Delta_0$  (for octahedral structures) also called as CFSE, which depends on

- (a) Charge on metal ion
- (b) Nature of Ligand
- (c) Element is of which transition series. (I, II, & III)

---

## 17.4 Strong and weak ligands

---

Those ligands which cause small degree of CFSE are called as weak ligands while those of higher value of CFSE are strong ligands. The nature of ligands in terms of can be arranged in ascending order (lower CFSE to higher CFSE)

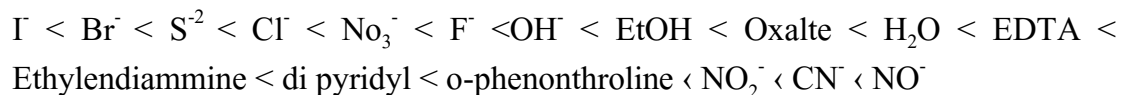

## 17.5 High and low spin complexes

---

The complexes can have high and low magnetic moment depending upon whether the electrons are paired or not. If the electrons are paired the magnetic moments of the complex is less and it is called as the low spin complexes while if the electrons are not paired then it is called as the high spin

Low and high spin complexes mainly depend on the comparative values of CFSE and the pairing energies. Stronger the ligand, higher the value of CFSE, more shall be the pairing of the electrons, while if the ligand is weak, lower shall be the value of CFSE and pairing shall be less preferred as to minimize the interelectronic repulsive interaction.

Spectrochemical series can be used for predicting whether spin pairing shall be of priority or not as shown in the fig.3 (a) here CFSE is less hence to avoid interelectronic repulsive interaction 4<sup>th</sup> electron enters in the  $e_g$  orbital forming the high spin complexes. While in fig.3 (b) as the ligand is strong the magnitude of CFSE is high as a result the 4<sup>th</sup> electron enters the  $t_{2g}$  orbital forming the low spin complexes.

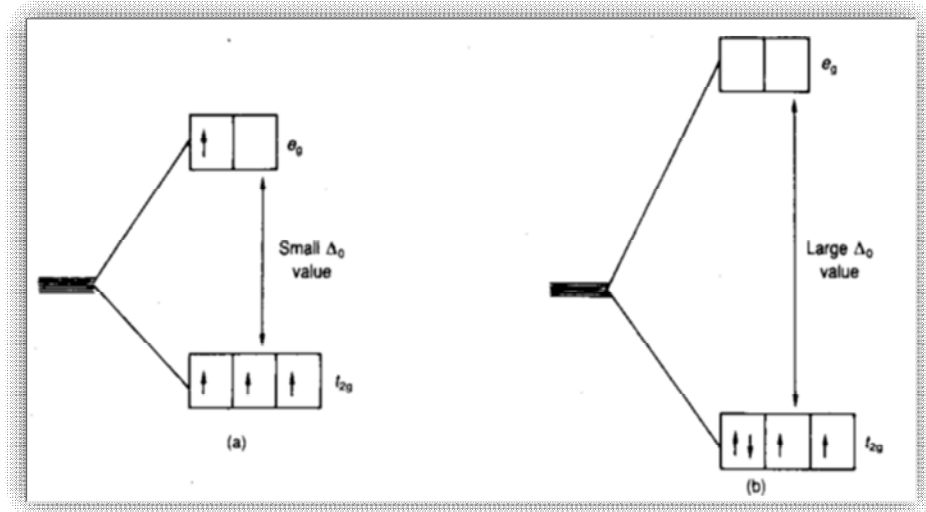

Figure-3 High and Low spin complex

(a)  $D^4$  high spin arranger (week liquid field)

(b)  $D^4$  low spin arranger (strong liquid field)

17.5 Table showing CFSE and electronic arrangement in octahedral complexes

Number of $d$ electrons	Arrangement in weak ligand field				Arrangement in strong ligand field			
	$t_{2g}$	$e_g$	CFSE $\Delta_o$	Spin only magnetic moment $\mu_s(D)$	$t_{2g}$	$e_g$	CFSE $\Delta_o$	Spin only magnetic moment $\mu_s(D)$
$d^1$	$\uparrow \square \square$	$\square \square$	-0.4	1.73	$\uparrow \square \square$	$\square \square$	-0.4	1.73
$d^2$	$\uparrow \uparrow \square$	$\square \square$	-0.8	2.83	$\uparrow \uparrow \square$	$\square \square$	-0.8	2.83
$d^3$	$\uparrow \uparrow \uparrow$	$\square \square$	-1.2	3.87	$\uparrow \uparrow \uparrow$	$\square \square$	-1.2	3.87
$d^4$	$\uparrow \uparrow \uparrow$	$\uparrow \square$	-1.2 +0.6 = -0.6	4.90	$\uparrow \downarrow \uparrow \uparrow$	$\square \square$	-1.6	2.83
$d^5$	$\uparrow \uparrow \uparrow$	$\uparrow \uparrow$	-1.2 +1.2 = -0.0	5.92	$\uparrow \downarrow \uparrow \downarrow \uparrow$	$\square \square$	-2.0	1.73
$d^6$	$\uparrow \downarrow \uparrow \uparrow$	$\uparrow \uparrow$	-1.6 +1.2 = -0.4	4.90	$\uparrow \downarrow \uparrow \downarrow \uparrow \downarrow$	$\square \square$	-2.4	0.00
$d^7$	$\uparrow \downarrow \uparrow \downarrow \uparrow$	$\uparrow \uparrow$	-2.0 +1.2 = -0.8	3.87	$\uparrow \downarrow \uparrow \downarrow \uparrow \downarrow$	$\uparrow \square$	-2.4 +0.6 = -1.8	1.73
$d^8$	$\uparrow \downarrow \uparrow \downarrow \uparrow \downarrow$	$\uparrow \uparrow$	-2.4 +1.2 = -1.2	2.83	$\uparrow \downarrow \uparrow \downarrow \uparrow \downarrow$	$\uparrow \uparrow$	-2.4 +1.2 = -1.2	2.83
$d^9$	$\uparrow \downarrow \uparrow \downarrow \uparrow \downarrow$	$\uparrow \downarrow \uparrow$	-2.4 +1.8 = -0.6	1.73	$\uparrow \downarrow \uparrow \downarrow \uparrow \downarrow$	$\uparrow \downarrow \uparrow$	-2.4 +1.8 = -0.6	1.73
$d^{10}$	$\uparrow \downarrow \uparrow \downarrow \uparrow \downarrow$	$\uparrow \downarrow \uparrow \downarrow$	-2.4 +2.4 = 0.0	0.00	$\uparrow \downarrow \uparrow \downarrow \uparrow \downarrow$	$\uparrow \downarrow \uparrow \downarrow$	-2.4 +2.4 = 0.0	0.00

Magnitude of the CFSE can be calculated by taking the help of exact values of the  $e_g$  and  $t_{2g}$  orbital energy in the octahedral and tetrahedral complexes as shown in the table

### Tetrahedral complexes

Regular tetrahedral is related to cube as show in fig.

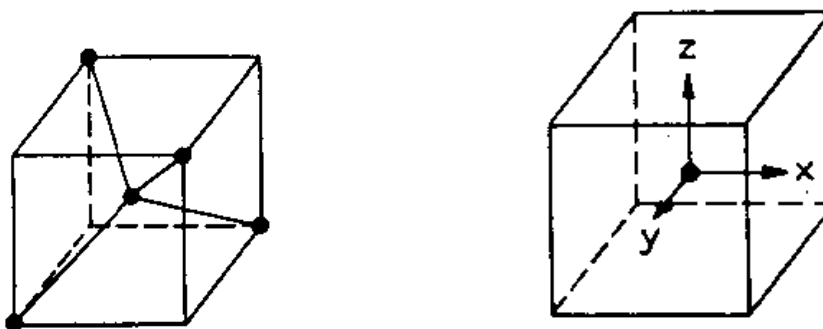
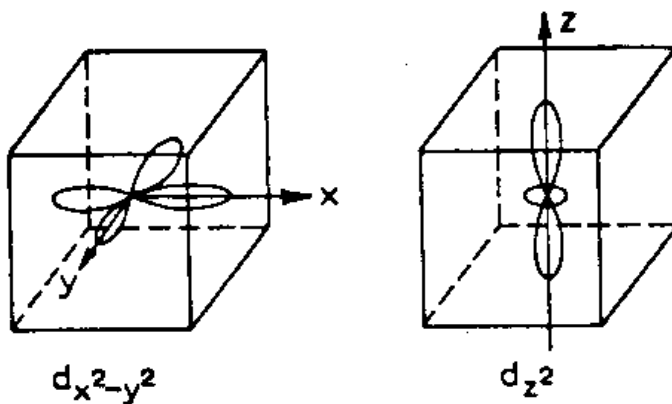

Figure-4 Relation of a tetrahedron to a cube

x, y and z coordinates points towards the face centre and axial orbitals (eg.  $d_{x^2-y^2}$  &  $d_{z^2}$ ) also points towards this direction while planar orbitals ( $t_{2g}$ ,  $d_{xy}$ ,  $d_{yz}$ ,  $d_{zx}$ ) points towards the centre of each of cube.

Approaching ligand direction does not match exactly the direction of  $e_g$  or  $t_{2g}$  orbitals.



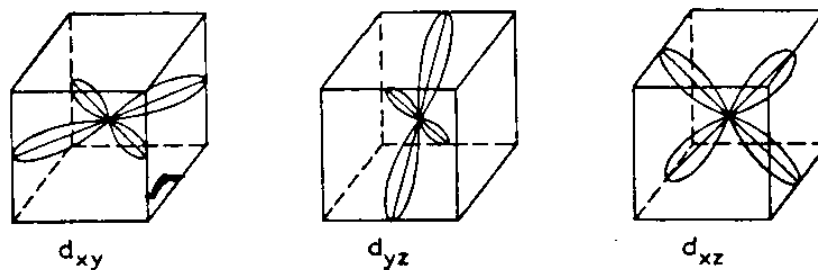

Figure-5 Orientation of d-orbitals relative to a cube

## 17.6 Angular description

$$\theta = \frac{109^{\circ}28'}{2}$$

$$\theta = 35^{\circ}16'$$

$$= 54^{\circ}44'$$

Fig-6

So  $t_{2g}$  orbitals are close to ligand as compared to  $e_g$  orbitals so suffer more repulsive interaction as compared to  $e_g$  orbitals hence  $t_{2g}$  energy is raised more as compared to  $e_g$  orbitals as shown on fig.6 and fig.7

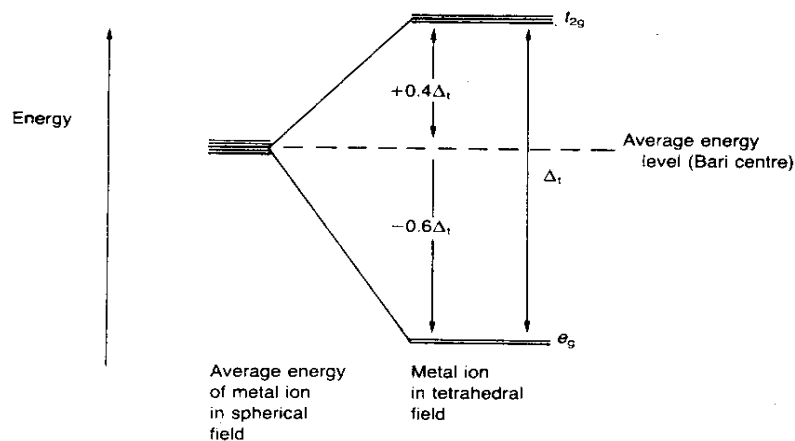

Figure-7 Energy level for d-orbitals in a tetrahedral field

Tetrahedral CFSE =  $\frac{4}{9}$  of CFSE of octahedral complexes and so  $\Delta_t < \Delta_0$  so energetically less favorable to pair up electron hence all tetrahedral complexes are high spin complexes.

**Table showing CFSE and electronic arrangement in tetrahedral and octahedral complexes**

Number of <i>d</i> electrons	Arrangement of electrons		Spin only magnetic moment $\mu(D)$	Tetrahedral CFSE $\Delta_t$	Tetrahedral CFSE scaled for comparison with octahedral values, assuming $\Delta_t = \frac{4}{9}\Delta_0$	Octahedral CFSE $\Delta_0$	
	$e_g$	$t_{2g}$				Weak field	Strong field
$d^1$			1.73	-0.6	-0.27	-0.4	-0.4
$d^2$			2.83	-1.2	-0.53	-0.8	-0.8
$d^3$			3.87	$-1.2 + 0.4 = -0.8$	-0.36	-1.2	-1.2
$d^4$			4.90	$-1.2 + 0.8 = -0.4$	-0.18	-0.6	-1.6
$d^5$			5.92	$-1.2 + 1.2 = 0.0$	0.00	0.0	-2.0
$d^6$			4.90	$-1.8 + 1.2 = -0.6$	-0.27	-0.4	-2.4
$d^7$			3.87	$-2.4 + 1.2 = -1.2$	-0.53	-0.8	-1.8
$d^8$			2.83	$-2.4 + 1.6 = -0.8$	-0.36	-1.2	-1.2
$d^9$			1.73	$-2.4 + 2.0 = -0.4$	-0.18	-0.6	-0.6
$d^{10}$			0.00	$-2.4 + 2.4 = 0.0$	0.00	0.0	0.0



---

## 17.7 Introduction of the spectra of transition metal complexes

---

In order to understand the absorption spectra of coordination complexes one has to learn the basic concepts of spin and orbital angular momentum of electron and have to understand the consequences of magnetic and inter electronic repulsion among the electrons of an atom or an ion of a given configuration.

The magnetic and interelectronic repulsion among the electrons give rise to various degenerate energy levels (called as terms) and non-degenerate energy levels (called as spectroscopic states) absorption of energy causes transition between these energy levels.

### 17.7.1 Orbital angular momentum of electron

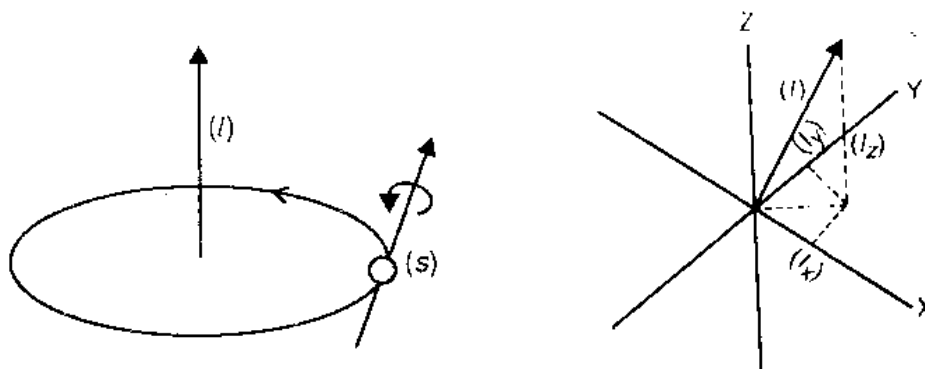

Figure-8

$(l)$  = orbital angular momentum vector

$l$  = angular momentum Quantum Numbers

$$\text{Magnitude of } (l) = \sqrt{l(l+1)} \frac{h}{2\pi}$$

Number of orientation possible for  $(l) = (2l + 1)$

### 17.7.2 Effect of field on the angular momentum vectors

If External magnetic field is applied along z-direction then only those components of (l) interacts with the external magnetic field which are along z-direction.

As there are  $(2l + 1)$  orientation so  $(2l + 1)$  components of (l) along z-direction and are called as  $m_l$  as shown below for  $l = 2$

$$\text{Orientation } (2l + 1) = (2 \times 2 + 1) = 5$$

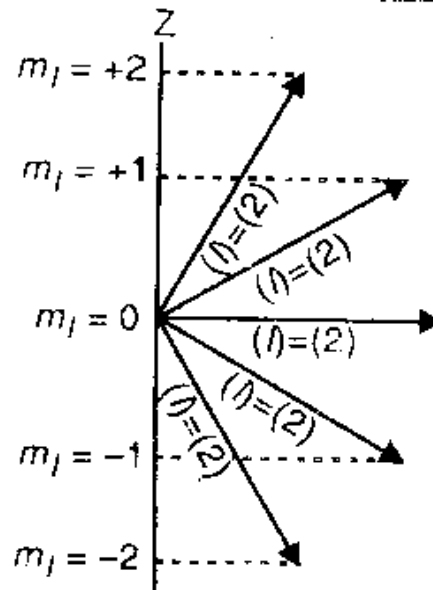

Figure-9

Likewise an electron also spin along its axis also generating spin angular momentum a vector Quantity (s).

$$\text{Magnitude of } (s) = \sqrt{s(s + 1)} \frac{h}{2\pi}$$

Where s is spin angular momentum vector. In the presence of the external magnetic field the vector (s) component along the magnetic field will be as shown below.

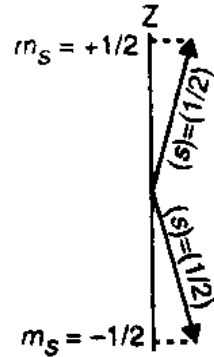

Fig-9

Allowed orientation when  $s = \frac{1}{2}$

For evaluating angular momentum  $\frac{h}{2\pi}$  is generally not taken for evaluation just for brevity.

From above discussion we can summarise the things as.

(L)	Vectors	L	Quantum Numbers	For single Electron System
(S)		S		

(L)	Vectors	L	Quantum Numbers	For Multi Electron System
(S)		S		

As (l) and (s) are vector quantities.

They can be combined and a resultant vector can be obtained.

### 17.7.3 Angular momentum comparing of single electron

The factors responsible for the combinations of (L) and (S) can be

(i) inter electronic repulsive interaction among the electrons.

(ii) negative interaction between the electron and the nucleus.

So the vector combination for the single electron system can be (L)-(L), (s)-(s), (L)-(s)

While for the multielectron system it can be

(L)-(L), (S)-(S), (L)-(S)

(A) (s)-(s) coupling

( $s_1$ ) & ( $s_2$ ) of two electron system can couple to give the resultant spin angular momentum ( $s$ )

$$|S| = \text{magnitude} = \sqrt{s(s+1)} \frac{h}{2\pi}$$

Where  $s$  = resultant spin Quantum numbers values of  $s = s_1 + s_2$  and  $s_1 - s_2$

Orientation of vector  $s = 2S + 1$

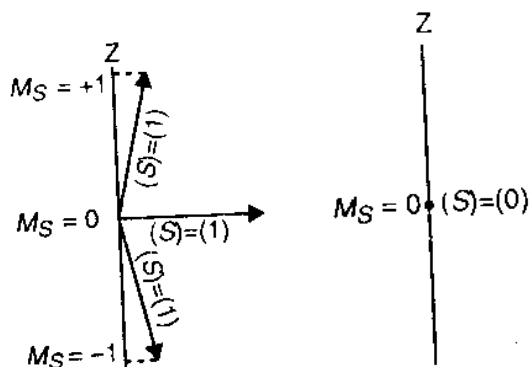

Figure-10

For multielectron system the resultant spin angular momentum can be evaluated by coupling the first two electrons momentum and then coupling the resultant with that of the angular momentum of the third electron.

### 17.7.4 Stable configuration

For multielectron system that configuration is highly stable which is having the maximum inter-electronic repulsive interaction hence the configurative with maximum stability shall be the one with maximum value of  $s$ .

---

## 17.8. Orbital angular momentum coupling (l-l) coupling

---

Orbital angular momentum ( $l_1$ ) of electron ( $e_1$ ) is perpendicular to the plane of orbit it can couple with ( $l_2$ ) of the electron ( $e_2$ ) to obtain the resultant orbital angular momentum vector ( $L$ ) as shown in figer.

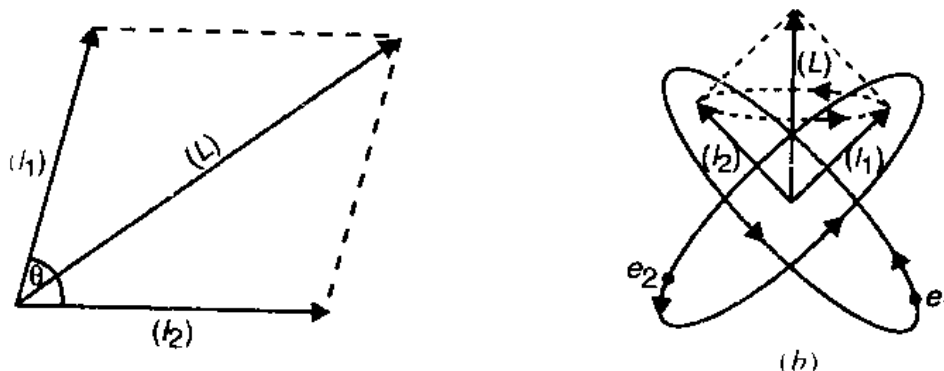

Figure-11

Angle between the orbital planes of electrons are Quantized maximum coupling shall be there when the electron are far apart as interelctronic repulsion shall be minimum. For maximum coupling electrons will more in the same direction and with same velocities making ( $L$ ) to have maximum magnitude

$$|L| = S\sqrt{s(s+1)}$$

$L$  = Resultant angular momentum Quantum number

$L = l_1 + l_2$  or  $l_2 - l_1$  (whichever is positive)

( $L$ ) Orientation will be given by  $2L + 1$

Q : For configuration  $p^1d^1$  what are the values of ( $L$ ) and gets orientation with external magnetic field ( $M_L$ )

Ans.  $P^1 d^1 = l_1 = 1 \quad l_2 = 2$

$$L = l_1 + l_2 \quad \text{to } l_2 - l_1$$

$$2 + 1 \quad 2 - 1$$

$$L = 3, 2, 1$$

For  $L = 3$

$$\text{Orientation of } (L) = 2L + 1 = 7$$

$$M_L = +L \text{ to } -L \text{ that is } +3, +2, +1, 0, -1, -2, -3$$

For  $L = 2$

$$\text{Orientation of } (L) = 2L + 1 = 5$$

$$M_L = +L \text{ to } -L = +2, +1, 0, -1, -2$$

For  $L = 1$

$$\text{Orientation of } (L) = 2L + 1 = 3$$

$$M_L = +L \text{ to } -L = +1, 0, -1$$

### 17.8.1 Orbital and spin coupling of single electron (l) – (s) coupling

Spin angular momentum vector (s) and orbital angular momentum vector (l) of a single electron can couple and give the resultant angular momentum vector (J). The origin of this coupling is magnetic in nature this coupling is maximum for those nucleus which are heavy and hence this coupling interaction is minimum for the lighter nucleus.

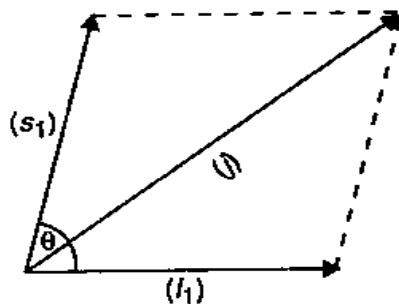

Figure-12

## (l) – (s) coupling : Russels – saunders coupling scheme

### 17.8.2. ENERGY TERM

For a given configuration say  $d^2$  Electron placement in the five degenerate d-orbital is done without considering electrons repulsive interaction. Consider the situation.

(a) One electron in  $d_{x^2-y^2}$  other in  $d_{xy}$  orbital

(b) One electron in  $d_{x^2-y^2}$  other in  $d_z^2$  orbital

In first situations (a) repulsion is maximum as both orbital are in the same plane xy while in the situation (b) repulsion is minimum as electrons are in xy plane along z-axis.

So various such arrangements of electrons in the degenerate orbital give rise to a set of degenerate energy levels called as ENERGY TERM. Which is written as  $(2s+1) L$

Since energy term arise because of electron repulsion which can be directly be evaluated by (l) – (l) and (s) – (s) coupling. Total number of energy level in energy term is given by  $(2s+1) (2L+1)$  e.g.  ${}^3F = (2 \times 1 + 1) (3 \times 2 + 1) = 21$  energy levels

### 17.8.3. ENERGY STATES

The energy levels of Energy term which are degenerate can split into various energy states spectroscopic states due to magnetic interaction which causes (l) – (s) coupling. Giving rise to ‘J’ Resultant angular. Angular momentum Quantum number J. It is equal to  $(2S+1) L_J$

### 17.8.4. (L) – (S) Russel – saunders coupling scheme

It is applied when inter electronic repulsive interelectronic is stronger than magnetic effect.

(a) In this scheme first (L) & (S) is evaluated.

(b) Write all possible energy terms.

(c) Couple (L) & (S) to evaluate J

e.g  $p^2$  configuration

$$l_{(1)} = 1$$

$$l_{(2)} = 1$$

$$L = l_1 + l_2 \quad \text{to} \quad l_1 - l_2$$

$$= 1 + 1 \quad \text{to} \quad 1 - 1$$

$$= 2, 1, 0; [0 \rightarrow s, 1 \rightarrow P, 2 \rightarrow D]$$

$$S = \frac{1}{2} + \frac{1}{2} \quad \text{and} \quad \frac{1}{2} - \frac{1}{2}$$

$$= \begin{array}{c} 1 \\ \downarrow \\ (2S + 1) \\ 3 \end{array} \quad \& \quad \begin{array}{c} 0 \\ \downarrow \\ (2S + 1) \\ 1 \end{array}$$

$$\text{Energy term} = {}^{(2S+1)}L$$

3S, 1S, 3P, 1P, 3D, 1D

$$J = L + S \quad \text{to} \quad L - S$$

L = 2 S = 0 J = 2+0 = 2 2-0 = 2	S = 1 L = 2 J = 2+1 to 2-1 3, 2, 1
${}^1D_2$ Energy State	${}^3D_3, {}^3D_2, {}^3D_1,$ Energy State

### 17.9. Effect of weak octahedral crystal field potential (volt) and weak tetrahedral crystal field potential $v_{tet}$ on terms.

For a given energy terms of a free metal in all the energy levels are degenerate in the absence of crystal field.

When the electrostatic interaction between the electrons of the metal and the ligand is weaker than interelectronic repulsive interaction between the d-electrons themselves than the octahedral and tetrahedral, Crystal field is considered as the weak field.



### 17.9.1. Electrostatic repulsive interrelations

Interelectronic repulsive interaction between d-electrons causing (l) – (l) and (s) – (s) coupling which give rise to energy terms  $\gg$  electrons interaction between d-electrons and weak  $v_{\text{oct}}$  or  $v_{\text{tet}} \gg$  spin orbit (l) – (s) coupling.

#### 17.9.2.(a) Effect of weak $v_{\text{oct}}$ or $v_{\text{tet}}$ on s term

S-term is orbital non degenerate hence it cannot be split by weak tetrahedral or octahedral ligand field.

#### 17.9.3.(b) Effect of weak $v_{\text{oct}}$ or $v_{\text{tet}}$ on p term

In P-term of configuration of metal ion having three degenerate orbital energy levels is not specified in the presence of weak octahedral or weak tetrahedral field.

#### 17.9.4.(c) Effect of weak $v_{\text{oct}}$ and $v_{\text{tet}}$ on D term

The degenerate energy levels of energy term D is not retained in presence of weak octahedral or weak tetrahedral field and is specified. The field considered for this splitting is considered so weak that the spin multiplicity is as it is retained, so the transition always occurs between the transition levels which are either singlet – singlet or triplet-triplet transition.

When the orbital angular momentum is conserved and not quenched by the ligand outside (in case of the heavier elements) than the L-S coupling occurs which splits the energy terms into spectroscopic states and then the mixing of the upper spectroscopic states of the lower energy term with that of the lower spectroscopic states of the upper energy terms takes place than making the relaxation to the spin selection rule

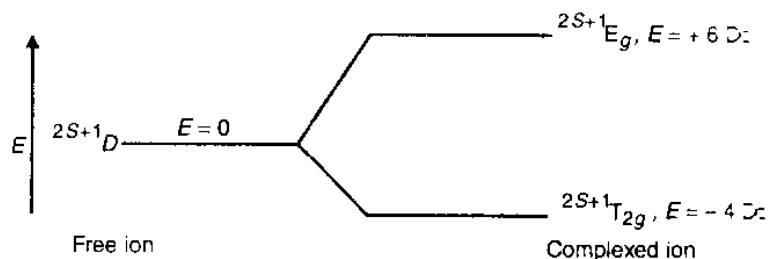

Figure-13

Splitting of D terms of  $d^1$  and  $d^6$  configuration in presence of weak voct.

In presence of tetrahedral field splitting is reversed because  $V_{tet} = -4/9 V_{oct}$ .

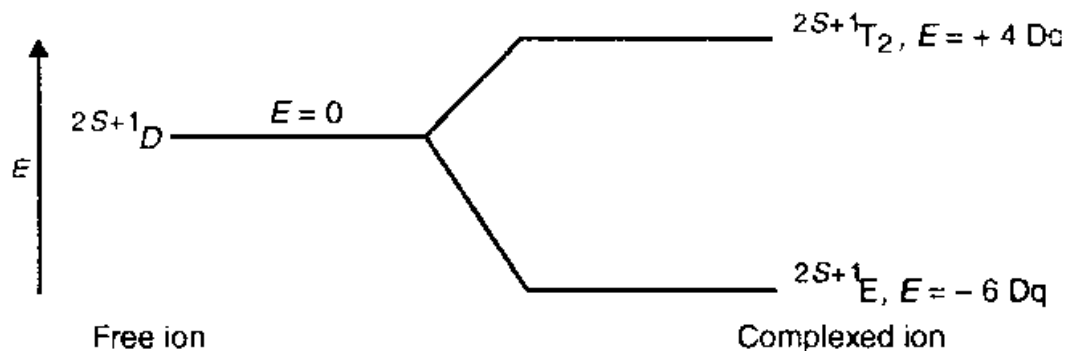

Figure-14

splitting pattern of  $d^n$  and  $d^{n+5}$  terms are same

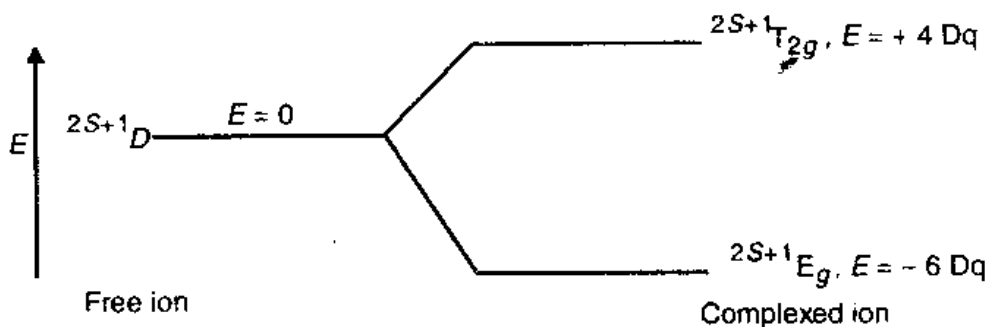

Figure-15

D term of  $d^9$  and  $d^4$  configuration of metal ion in weak octahedral field.

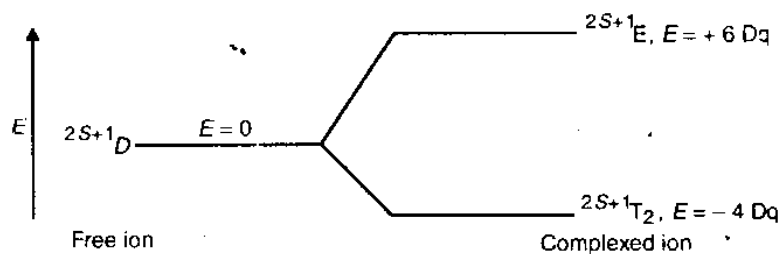
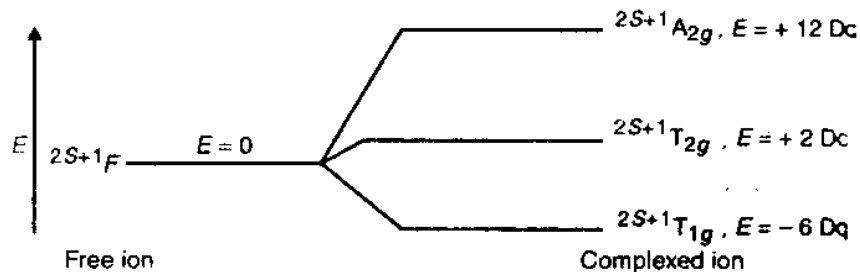

Figure-16

D term of  $d^9$  and  $d^4$  configuration of metal ion in weak tetrahedral field.

17.9.5. Splitting of F term under weak  $V_{oct}$  weak  $V_{tet}$



Splitting of D term of  $d^2$  and  $d^7$  configuration under weak  $V_{oct}$

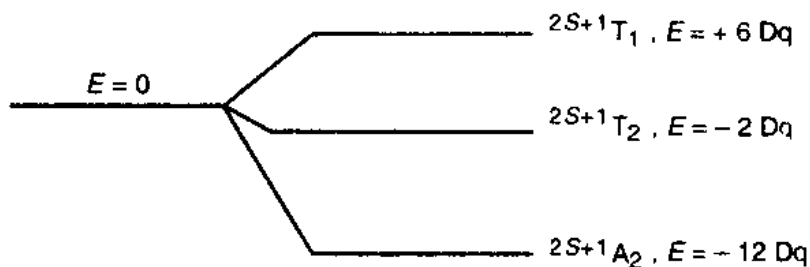

Splitting of D term of  $d^2$  and  $d^7$  configuration under weak  $V_{tet}$

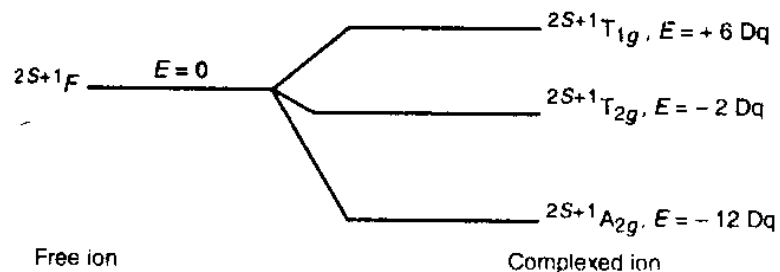

Splitting of D term of  $d^3$  and  $d^8$  configuration under weak  $V_{oct}$

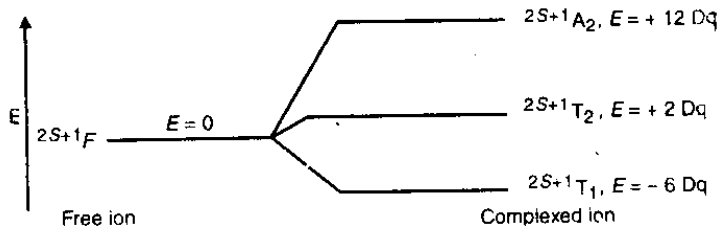

Splitting of D term of  $d^3$  and  $d^8$  configuration under weak  $V_{tet}$

- $d^n$  and  $d^{n+5}$  : Same splitting pattern
- $d^n$  and  $d^{10-n}$  : reverse splitting pattern (in same ligand environment)

In all these transition it is considered that (a) crystal field is weak wether it is tetrahedral or octahedral (b) spin multiplicity is retained during the transition (because electrons crystal field is not of sufficient strength to cause spin pairing)

## 17.10 Correlation diagram ORGEL diagram

Orgel diagram are called as correlation diagram showing splitting of energy term on y axis and strength of weak octahedral or tetrahedral field on x-axis explaining simple crystal field spectra originating from d-d transition of transition metal complexes is called as orgel diagram.

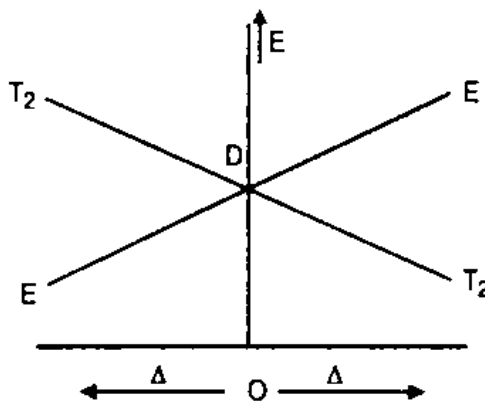

Figure-16

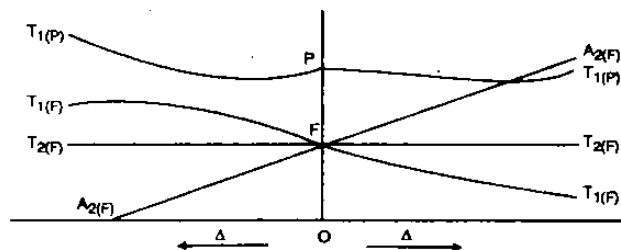

Figure-17

Orgel diagram can be used for spectral interpretation in weak field complexes and not for strong field complexes.

## 17.11. Strong field effect Tanabe-sugano diagram

Simple Orgel diagram have limitations

- (a) It can explain only high-spin cases i.e. weak field complex spectra.
- (b) It can interpret only that spectra dealing with spin allowed transitions.

Tanabe sugano diagram are useful for interpreting spectra pertaining to weak and strong ligand field. T-S diagram have following features

1. As a reference point ground state is taken on the horizontal point remaining energy states are plotted relative to this (ground state).
2. Those states whose spin-multiplicity lower than ground state /low spin terms are included in TS diagram.
3. For making T.S. diagram general for different ligands (strong and weak) both which effect  $D_q/B$ ;  $B$  (Racah parameter) &  $D_q$  (crystal field splitting)

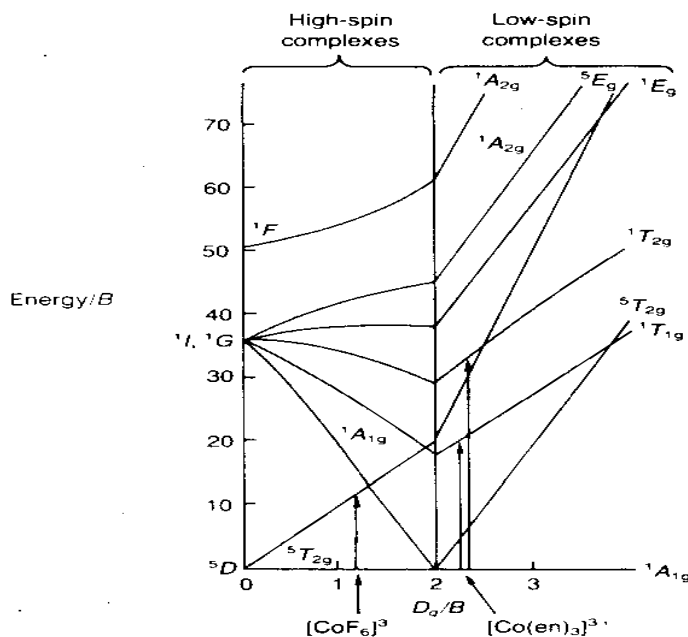

Figure-18

## Tanabe-sugano diagram for d<sup>6</sup> case eg Co<sup>3+</sup>

In is diagram it is seen that

1. at  $10 D_q/B = 20$  there is discontinuity shown by a vertical line.
2. at  $10 D_q/B = 20$  spin pairing of electrons occurs.
3. left of vertical line shows high spin (weak field couples) and to the right low spin complexes (strong field complexes)
4. ground state is  $5D$  in pressure of octahedral field it is specified into  $5T_{2g}$  ground state and  $5E_g$  excited state.

### **17.11.1. Left part of T.S. diagram**

For  $[\text{CoF}_6]^{3-}$  is a high spin complex and a single peak corresponding to it at  $13000 \text{ cm}^{-1}$  (transition  $5T_{2g} \rightarrow 5E_g$ )

### **Right part of T.S. diagram**

For  $[\text{Co(en)}_3]^{3+}$  a low spin complexes shows transition  $A_{1g} \rightarrow {}^1T_{1g}$  and  ${}^1A_{1g} \rightarrow {}^1T_{2g}$

---

## **17.12 Spin pairing energies**

---

Hunds rule states that energy is required to pair to electrons so they do it in a pair to minimize total energy, as such when two electrons occupy the same orbital interelectronic repulsive interaction is maximum greater the repulsion effect more shall be the energy of orbital.

Jorgensen and states found for transition metal the repulsion effect on basis of first order perturbation theory and calculated it as

$$E(s) = E(qd^n) + [s(s+1) - s(s+1)] D$$

$E(qd^n)$  :- weighted mean energy of the configuration

S = spin Quantum number

$S(s+1)$  = average value of total spin angular momentum

D = Metal parameter

$$\Delta E \quad :- E(s-1) - E(s) = 2SD$$

Generally spin pairing energy value increases from p to D to 5 orbital. Carbon an element that doesn't follow this rule where spin pairing energy increases in opposite order (s to D to P)

(A) spin pairing energy when electron transition from  $\downarrow\downarrow$  to  $\uparrow\downarrow$  decreases the electronic repulsion.

(B) In transition elements working in a period from left to right size decreases because added new electron do not get shielded from the increased nuclear charge but at the end of period size increases due to electronic repulsive interaction.

---

### 17.13. SUMMARY

---

The topic mainly deals with the spectra of the transition metal complexes where the basic concepts of CFSE is explained and the nature of the ligand whether strong or weak can be evaluated through spectrochemical series, which provide the authentic way whether the pairing will be dominant or not. The (l)-(l)coupling and (s)-(s) coupling which is mainly due to repulsive interaction give rise to energy terms and coupling of the spin(S) and orbital angular momentum vectors(L) gives resultant angular momentum (J).the degeneracy of energy terms is ruptured and spectroscopic states are obtained which are given by  $^{2S+1}L_J$ , the value of J can be L+S for less than half filled orbitals and less than half for more than half filled orbitals.the spectra of the complexes when the field is weak octahedral and weak tetrahedral had been explained by the Orgel diagram. Whilst the spectra in presence of the strong field had been explained by the help of Tanabe Sugano diagram. In the last part of the topic the spin paring is explained.

---

### 17.14. QUESTIONS

---

- 1 what do understand by the term CFSE?
- 2 what are the factors that effect the magnitude of CFSE
- 3 Show how the crystal field splitting take place in the octahedral complexes.
- 4 why tetrahedral complexes are always of high spin?

- .5 Explain the crystal field splitting in the tetrahedral complexes
- 6 How distribution of d-electrons takes place in octahedral and tetrahedral complexes?
- .7 Calculate CFSE for  $d^3$ ,  $d^4$  and  $d^7$  ions in the octahedral complexes both for low and high spin
- 8 Give the various energy terms for  $d^2$  configuration
- .9 what are the Orgel diagrams, explain with example of  $d^1$  metal ion in octahedral complexes
- 10 explain the Orgel diagrams, explain with example of  $d^1$  metal ion in tetrahedral complexes
- 11 what Russel's Saunders coupling scheme, explain?
- 12 what is J and how its value can be determined for the complexes?
- 13 what is Tanabe Sugano diagram and what are its uses?
14. What do understand by the spectroscopic terms?
- .15. How many degenerate energy levels are for  $^2D$  energy term

---

### **17.15 References:**

---

1. Advanced inorganic chemistry by J.D.Lee
2. Inorganic Chemistry, Kalia



---

# Unit – 18 : Electronic spectra of complexes

---

## Structure of Unit:

- 18.0 Objectives
- 18.1 Introduction
- 18.2 Electronic spectra of complexes
- 18.3 Electronic absorption spectroscopy principles
- 18.4 The Russell Saunders Coupling Scheme
- 18.5 Selection rules
- 18.6 Electronic Transitions
- 18.7 Jablonski diagram & Molecular emission spectra
- 18.8 Transitions absorption spectra
- 18.9 Orgel diagrams for First-Row Transition Metal Ions
- 18.10 Spectrochemical Series and Nephelauxetic effect
- 18.11 Racah parameters
- 18.12 Summery
- 18.13 Review Question
- 18.14 Reference and Suggested readings

---

## 18.0 Objectives

---

At the end of the unit learner will be able to

**Familiar with Ion complexes.**

**Learn the spectro chemical & nephelauxetic series.**

- Understand about Charge transfer & absorption spectra.
- Increase knowledge about Jablonski diagram & Molecular emission spectra.

**Familiar with Electronic spectra of Transition Metal Ions complexes.**

---

## **18.1 Introduction**

---

**This Chapter deals with increasing the knowledge of electronic spectra of complexes and its compound, and their knowledge about Electronic spectra of transition metal ions complexes and as well as Charge transfer & Molecular emission spectra. Chapter also explain brief about spectro chemical series, nephelauxetic series and calculations of  $Dq$ ,  $B$ ,  $\beta$  parameters.**

---

## **18.2 Electronic spectra of complexes**

---

Spectra are broadly classified into two groups (i) emission spectra and (ii) absorption spectra **i. Emission spectra:** Emission spectra are of three kinds (a) continuous spectra, (b) band spectra and (c) line spectra.

(A) Continuous spectra: Solids like iron or carbon emit continuous spectra when they are heated until they glow. Continuous spectrum is due to the thermal excitation of the molecules of the substance.

(B) Band spectra: The band spectrum consists of a number of bands of different colours separated by dark regions. The bands are sharply defined at one edge called the head of the band and shade off gradually at the other edge. Band spectrum is emitted by substances in the molecular state when the thermal excitement of the substance is not quite sufficient to break the molecules into continuous atoms.

(C) Line spectra: A line spectrum consists of bright lines in different regions of the visible spectrum against a dark background. All the lines do not have the same intensity. The number of lines, their nature and arrangement depends on the nature of the substance excited. Line spectra are emitted by vapours of elements. No two elements do ever produce similar line spectra.

**ii. Absorption spectra:** When a substance is placed between a light source and a spectrometer, the substance absorbs certain part of the spectrum. This spectrum is called the absorption spectrum of the substance. Electronic absorption spectrum is of two types. d-d spectrum and charge transfer spectrum. d-d spectrum deals with the electronic transitions within the d-orbitals. In the charge – transfer spectrum, electronic transitions occur from metal to ligand or vice-versa. three types of transitions spectra are important to consider are Metal to Ligand Charge Transfer (MLCT), Ligand to Metal Charge Transfer (LMCT), and d-d transitions. Studying spectra provides information about bonding and structure in these species. Transition metal spectroscopic transitions are employed in industrial pigments, display devices, lasers etc

---

### 18.3 Electronic absorption spectroscopy principles:

---

Electronic absorption spectroscopy requires consideration of the following principles:

- a. ***Franck-Condon Principle:*** Electronic transitions occur in a very short time (about 10-15 sec.) and hence the atoms in a molecule do not have time to change position appreciably during electronic transition .So the molecule will find itself with the

same molecular configuration and hence the vibrational kinetic energy in the excited state remains the same as it had in the ground state at the moment of absorption.

- b. Electronic transitions between vibrational states:** Frequently, transitions occur from the ground vibrational level of the ground electronic state to many different vibrational levels of particular excited electronic states. Such transitions may give rise to vibrational fine structure in the main peak of the electronic transition. Since all the molecules are present in the ground vibrational level, nearly all transitions that give rise to a peak in the absorption spectrum will arise from the ground electronic state. If the different excited vibrational levels are represented as  $U_1$ ,  $U_2$ , etc., and the ground state as  $U_0$ , the fine structure in the main peak of the spectrum is assigned to  $U_0 \rightarrow U_0, \Sigma$  (longest wave length) transition.
- c. Symmetry requirement:** Electronic transitions occur between split 'd' levels of the central atom giving rise to so called d-d or ligand field spectra. The spectral region where these occur spans the near infrared, visible and U.V. region.

Ultraviolet (UV)	Visible (Vis)	Near infrared (NIR)	
50,000 - 26300	26300 - 12800	12800 - 5000	cm <sup>-1</sup>
200 - 380	380 - 780	780 - 2000	nm

---

## 18.4 The Russell Saunders Coupling Scheme:

---

### ❖ Quantum Numbers

Principal Quantum Number. Within each shell an electron can occupy an orbital which is further characterised by an Orbital Quantum Number,  $l$ , where  $l$  can take all values in the range:

$$l = 0, 1, 2, 3, \dots, (n-1),$$

traditionally termed s, p, d, f, etc. orbitals after the lines in alkali metal spectra: sharp, principal, diffuse, and fundamental.

Each orbital has a characteristic shape reflecting the motion of the electron in that particular orbital, this motion being characterised by an angular momentum that reflects the angular velocity of the electron moving in its orbital. A quantum mechanics approach to determining the energy of electrons in an element or ion is based on the results obtained by solving the Schrödinger Wave Equation for the H-atom. The various solutions for the different energy states are characterised by the three quantum numbers,  $n$ ,  $l$  and  $m_l$ .

$m_l$  is a subset of  $l$ , where the allowable values are:  $m_l = l, l-1, l-2, \dots, 1, 0, -1, \dots, -(l-2), -(l-1), -l$ .

There are thus  $(2l + 1)$  values of  $m_l$  for each  $l$  value,

i.e. one s orbital ( $l = 0$ ), three p orbitals ( $l = 1$ ), five d orbitals ( $l = 2$ ), etc.

There is a fourth quantum number,  $m_s$ , that identifies the orientation of the spin of one electron relative to those of other electrons in the system. A single electron in free space has a fundamental property associated with it called spin, arising from the spinning of an asymmetrical charge distribution about its own axis. Like an electron moving in its orbital around a nucleus, the electron spinning about its axis has associated with its motion a well defined angular momentum. The value of  $m_s$  is either  $+\frac{1}{2}$  or  $-\frac{1}{2}$ .

In summary then, each electron in an orbital is characterised by four quantum numbers:

<b>Quantum Numbers</b>	
$n$	Principal Quantum Number - largely governs size of orbital and its energy
$l$	Azimuthal/Orbital Quantum Number - largely determines shape of orbital
$m_l$	Magnetic Quantum Number
$m_s$	Spin Quantum Number - either $+\frac{1}{2}$ or $-\frac{1}{2}$ for single electron

❖ **Russell Saunders coupling:**

The ways in which the angular momenta associated with the orbital and spin motions in many-electron-atoms can be combined together are many and varied. In spite of this seeming complexity, the results are frequently readily determined for simple atom systems and are used to characterise the electronic states of atoms.

The interactions that can occur are of three types.

- spin-spin coupling
- orbit-orbit coupling
- spin-orbit coupling

There are two principal coupling schemes used:

- Russell-Saunders (or L - S) coupling
- and j - j coupling.

In the Russell Saunders scheme it is assumed that Spin-spin coupling  $>$  orbit-orbit coupling  $>$  spin-orbit coupling.

This is found to give a good approximation for first row transition series where J coupling is ignored, however for elements with atomic number greater than thirty, spin-orbit coupling becomes more significant and the j-j coupling scheme is used.

### **Spin-Spin coupling**

S - the resultant spin quantum number for a system of electrons. The overall spin S arises from adding the individual  $m_s$  together and is as a result of coupling of spin quantum numbers for the separate electrons.

**Orbit-Orbit coupling** L - the total orbital angular momentum quantum number defines the energy state for a system of electrons. These states or term letters are represented as follows

**Spin-Orbit coupling** Coupling occurs between the resultant spin and orbital momenta of an electron which gives rise to J the total angular momentum quantum number. Multiplicity occurs when several levels are close together and is given by the formula  $(2S+1)$ . The Russell Saunders term symbol that results from these considerations is given by:

$(2S+1)L$

As an example, for a  $d^1$  configuration:

$S = +\frac{1}{2}$ , hence  $(2S+1) = 2$

$L=2$

and the Russell Saunders Ground Term is written as  $^2D$

The Russell Saunders term symbols for the other free ion configurations are given in the Table below.

<b>Terms for <math>3d^n</math> free ion configurations</b>		
<b>Configuration</b>	<b>Ground Term</b>	<b>Excited Terms</b>
$d^1, d^9$	$^2D$	-
$d^2, d^8$	$^3F$	$^3P, ^1G, ^1D, ^1S$
$d^3, d^7$	$^4F$	$^4P, ^2H, ^2G, ^2F, 2 \times ^2D, ^2P$
$d^4, d^6$	$^5D$	$^3H, ^3G, 2 \times ^3F, ^3D, 2 \times ^3P, ^1I, 2 \times ^1G, ^1F, 2 \times ^1D, 2 \times ^1S$
$d^5$	$^6S$	$^4G, ^4F, ^4D, ^4P, ^2I, ^2H, 2 \times ^2G, 2 \times ^2F, 3 \times ^2D, ^2P, ^2S$

#### ❖ **Hund's Rules**

The Ground Terms are deduced by using Hund's Rules. The two rules are:

- 1) The Ground Term will have the maximum multiplicity
- 2) If there is more than 1 Term with maximum multiplicity, then the Ground Term will have the largest value of L.

#### ❖ **The Crystal Field Splitting of Russell-Saunders terms**

The effect of a crystal field on the different orbitals (s, p, d, etc.) will result in splitting into subsets of different energies, depending on whether they are in an

octahedral or tetrahedral environment. The magnitude of the d orbital splitting is generally represented as a fraction of  $\Delta_{\text{oct}}$  or  $10Dq$ .

The ground term energies for free ions are also affected by the influence of a crystal field and

**The Crystal Field Splitting of Russell-Saunders terms in high spin octahedral crystal fields.**

Russell-Saunders Terms	Crystal Field Components
S	$A_{1g}$
P	$T_{1g}$
D	$E_g, T_{2g}$
F	$A_{2g}, T_{1g}, T_{2g}$
G	$A_{1g}, E_g, T_{1g}, T_{2g}$
H	$E_g, 2 \times T_{1g}, T_{2g}$
I	$A_{1g}, A_{2g}, E_g, T_{1g}, T_{2g}$

field and an analogy is made between orbitals and ground terms that are related due to the angular parts of

their electron distribution. The effect of a crystal

field on different orbitals in an octahedral field environment will cause the d orbitals to split to give  $t_{2g}$  and  $e_g$  subsets and the D ground term states into  $T_{2g}$  and  $E_g$ , (where upper case is used to denote states and lower case orbitals). f orbitals



are split to give subsets known as  $t_{1g}$ ,  $t_{2g}$  and  $a_{2g}$ . By analogy, the F ground term when split by a crystal field will give states known as  $T_{1g}$ ,  $T_{2g}$ , and  $A_{2g}$ .

Note that it is important to recognise that the F ground term here refers to states arising from d orbitals and not f orbitals and depending on whether it is in an octahedral or tetrahedral environment the lowest term can be either  $A_{2g}$  or  $T_{1g}$ .

---

## 18.5 Selection rules:

---

We have seen that some transitions are not allowed, for example transitions where the spin of the electron is changed are spin-forbidden. This does not mean that such a transition will never occur, but that it is less likely and that the intensity (molar absorption coefficient) of such an absorption band is very low. Whether transitions are allowed or forbidden, and to what degree they may be forbidden depends on selection rules:

### (i) Spin selection rule

Electromagnetic radiation usually cannot change the relative orientation of an electron spin. The selection rule states that the overall spin  $S$  of a complex must not change during an electronic transition, hence,  $\Delta S = 0$ .

This selection rule can be relaxed by spin-orbit coupling, i.e., coupling between spin angular momentum and orbital angular momentum. However, spin-forbidden transitions remain generally much weaker than spin-allowed transitions. Spin-orbit coupling is particularly strong for heavy d-metals. In the 3d series, spin-forbidden transitions have  $\epsilon_{\text{max}} = 1 \text{ L mol}^{-1} \text{ cm}^{-1}$ . In an octahedral  $d^3$  transition-metal complex, the  $2E_g \leftarrow 4A_{2g}$  transition is spin-forbidden. It is still visible as a very weak absorption band in the UV-visible spectrum (see above).

### (ii) Laporte selection rule

The Laporte selection rule is particularly applicable for centrosymmetric molecules, i.e., molecules with an inversion centre. Orbitals and states in such molecules can be described with the symmetry labels g (gerade) and u (ungerade). Laporte-allowed transitions are accompanied with a change of parity (g and u); this means, transitions from a g-state to a u state and vice versa are Laporte-allowed and transitions from a g- to a g-state and from a u- to a u-state are Laporte-forbidden. All d orbitals are gerade (have g symmetry). Therefore, d-d transitions, e.g.,  $4T_{2g} \leftarrow 4A_{2g}$  in an octahedral  $d^3$  complex, are Laporte-forbidden.

The Laporte selection rule is relaxed by (a) deviation of perfect centrosymmetric symmetry due to ligands of less symmetry or chelate ligands and (b) asymmetric vibrations. While d orbitals are always centrosymmetric by themselves, for a non-centrosymmetric ligand field the Laporte selection rule is strictly not applicable anymore. As a consequence, Laporte forbidden d-d transitions have  $\epsilon_{\text{max}} = 20$  to  $100 \text{ L mol}^{-1} \text{ cm}^{-1}$ , while Laporte-allowed d-d transitions have  $\epsilon_{\text{max}} = \text{ca. } 500 \text{ L mol}^{-1} \text{ cm}^{-1}$ .

### (iii) Symmetry-allowed transitions

Transitions which are not governed by symmetry restrictions (e.g. Laporte rule) have much larger intensities in the electronic absorption spectra. Such transitions are usually charge transfer bands that give rise to intense colorations.

---

## 18.6 Electronic Transitions

---

The following electronic transitions are possible:

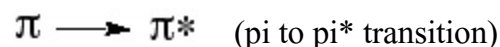

$n \longrightarrow \pi^*$  (n to pi star transition)

$\sigma \longrightarrow \sigma^*$  (Sigma to sigma star transition)

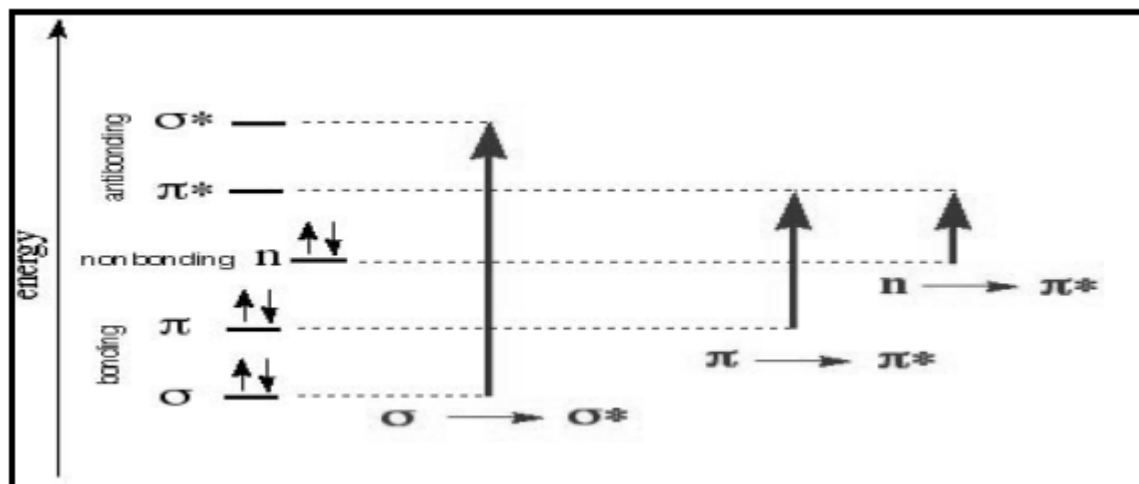

The **sigma to sigma\*** transition requires an absorption of a photon with a wavelength which does not fall in the UV-vis range. Thus, only **pi to pi\*** and **n to pi\*** transitions occur in the UV-vis region are observed.

---

## 18.7 Jablonski diagram

---

A **Jablonski diagram** is a diagram that illustrates the **electronic states** of a **molecule** and the transitions between them. The states are arranged vertically by energy and grouped horizontally by **spin multiplicity**. **Nonradiative transitions** are indicated by squiggly arrows and **radiative transitions** by straight arrows. The vibrational ground states of each electronic state are indicated with thick lines, the higher vibrational states with thinner lines.

Radiative transitions involve the absorption, if the transition occurs to a higher energy level, or the emission, in the reverse case, of a **photon**. Nonradiative transitions arise through several different mechanisms, all differently labeled in the diagram. Relaxation of the excited state to its lowest vibrational level is called **Vibrational relaxation**. This process involves the dissipation of energy from the molecule to its surroundings, and thus it cannot occur for isolated molecules. A second type of nonradiative transition is **internal conversion** (IC), which occurs when a vibrational state of an electronically excited state can couple to a vibrational state of a lower electronic state. A third type is **intersystem crossing** (ISC); this is a transition to a state with a different spin multiplicity. In molecules

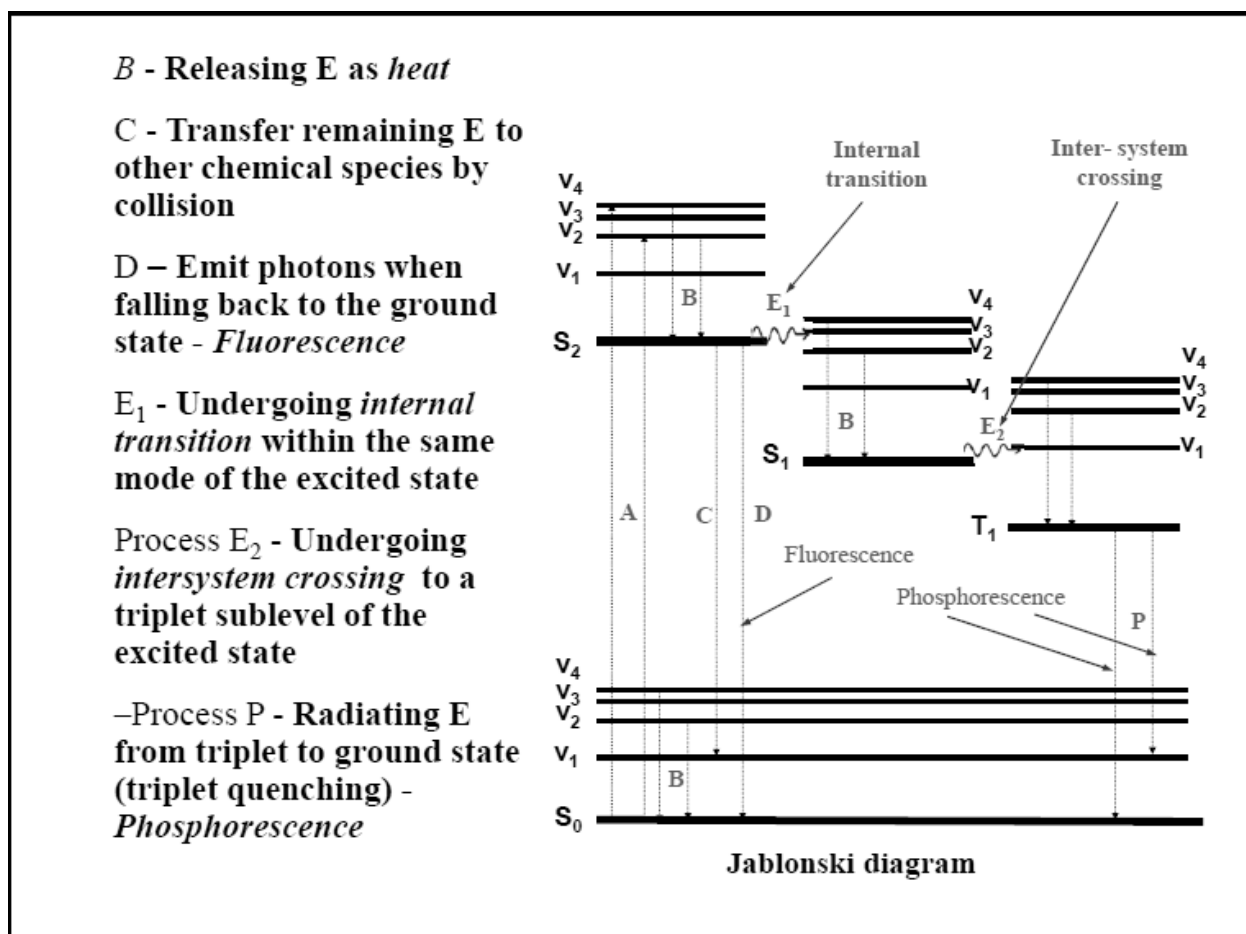

with large **spin-orbit coupling**, intersystem crossing is much more important than

in molecules that exhibit only small spin-orbit coupling. This type of nonradiative transition can give rise to phosphorescence.

**•Two types of molecular emission spectra**

**–Fluorescence**

- In the case fluorescence the energy emitted can be the same or smaller (if heat is released before radiation) than the corresponding molecular absorption spectra.
- e.g. absorption in UV region - emission in UV or visible region (the wavelength of visible region is longer than that of UV thus less energy)
- Fluorescence emission is generally short-lived (e.g.  $\mu\text{s}$ )

**–Phosphorescence**

- Phosphorescence generally takes much longer to complete (called *metastable*) than fluorescence because of the transition from triplet state to ground state involves altering the electron spin. If the emission is in visible light region, the light of excited material fades away gradually

❖ **Molecular Emission Spectra:**

**18.8 Transitions absorption spectra:**

❖ **d-d Transitions spectra**

From these two molecular orbital energy diagrams for transition metals, we see that the pi donor ligands lie lower in energy than the pi acceptor ligands. According to the spectral chemical series, one can determine whether a ligand will behave as a pi accepting or pi donating. When the ligand is more pi donating, its own orbitals are lower in energy than the  $t_{2g}$  metal orbitals forcing the frontier orbitals to involve an antibonding  $\pi^*$  (for  $t_{2g}$ ) and an antibonding  $\sigma^*$  (for eg). This is in contrast to the pi accepting ligands which involve a bonding  $\pi$  ( $t_{2g}$ ) and

an antibonding sigma\* ( $\sigma^*$ ). Because of this, the d-d transition (denoted above by  $\delta$ ) for the pi acceptor ligand complex is larger than the pi donor ligand. In the spectra, we would see the d-d transitions of pi acceptor ligands to be of a higher frequency than the pi donor ligands. In general though, these transitions appear as weakly intense on the spectrum because they are Laporte forbidden. Due to vibronic coupling; however, they are weakly allowed and because of their relatively low energy of transition, they can emit visible light upon relaxation which is why many transition metal complexes are brightly colored. The molar extinction coefficients for these transitions are around 100.

### ❖ **Charge Transfer (CT) Transitions**

Electronic transitions that occur between spectroscopic states for the metal ion in the ligand field. However, these are not the only transitions for which absorptions occur. Ligands are bonded to metal ions by donating electron pairs to orbitals that are essentially metal orbitals in terms of their character. Transition metals also have nonbonding  $eg$  or  $t_{2g}$  orbitals (assuming an octahedral complex) arising from the  $d$  orbitals that may be partially filled, and the ligands may have empty nonbonding or anti bonding orbitals that can accept electron density from the metal. For example, both CO and CN $_2$  have empty  $\pi^*$  orbitals that can be involved in this type of interaction. Movement of electron density from metal orbitals to ligand orbitals and vice versa is known as *charge transfer*. The absorption bands that accompany such shifts in electron density are known as *charge transfer bands*.

Charge transfer (CT) bands are usually observed in the ultraviolet region of the spectrum, although in some cases they appear in the visible region. Consequently, they frequently overlap or mask transitions of the  $d - d$  type. Charge transfer bands are of the spin-allowed type, so they have high intensity. If the metal is in a low oxidation state and easily oxidized, the charge transfer is more likely to be of the metal-to-ligand type, indicated as  $M \rightarrow L$ . A case of this type occurs in  $\text{Cr}(\text{CO})_6$ , where it is easy to move electron density from the metal atom (which is in the 0 oxidation state), especially because the CO ligands have donated six pairs of electrons to the Cr. The empty orbitals on the CO ligands are  $\pi^*$  orbitals. In this

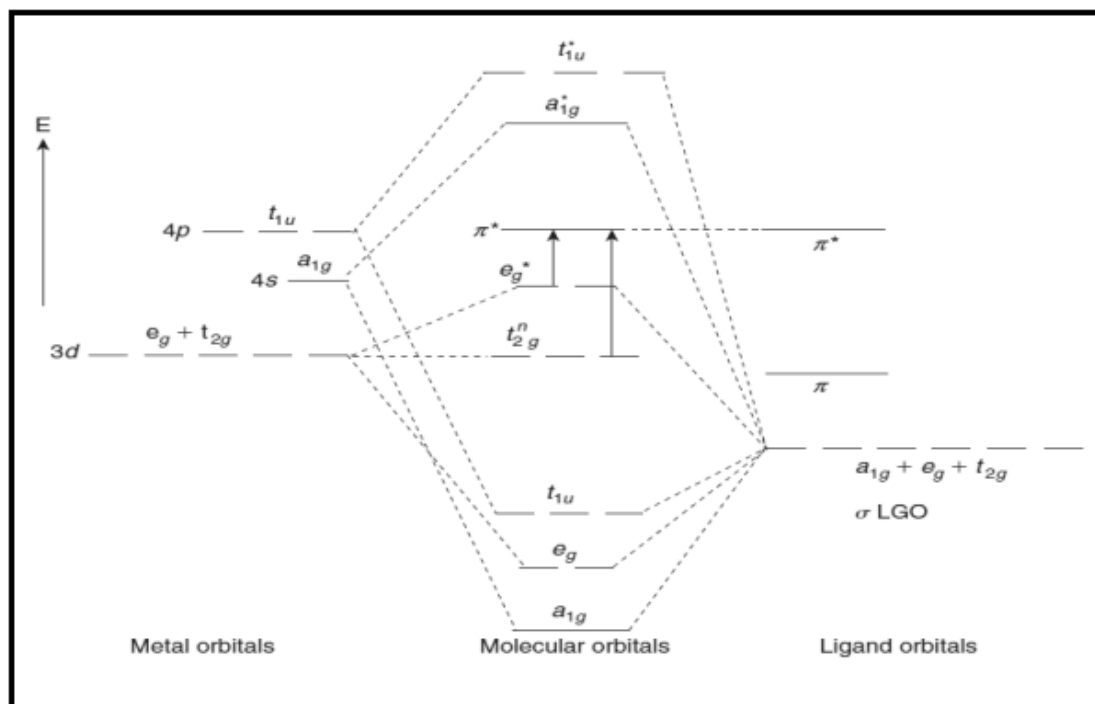

case, the electrons are in nonbonding  $t_{2g}$  orbitals on the metal so the transition is designated as  $t_{2g} \rightarrow \pi^*$ . In other cases, electrons in the  $eg^*$  orbitals are excited to the empty  $\pi^*$  orbitals on the ligands. Below Figure shows these cases on a modified molecular orbital diagram for an octahedral complex. Although CO is a ligand that has  $\pi^*$  acceptor orbitals, other ligands of this type include NO,  $\text{CN}^-$ , olefins, and pyridine.

The intense purple colour of  $\text{MnO}_4^-$  is due to a charge transfer band that occurs at approximately  $18,000 \text{ cm}^{-1}$  and results from a transfer of charge from oxygen to the  $\text{Mn}^{7-}$ . In this case, the transfer is indicated as  $\text{L} \rightarrow \text{M}$ , and it results from electron density being shifted from filled  $p$  orbitals on oxygen atoms to empty orbitals in the  $e$  set on Mn. As a general rule, the charge transfer will be  $\text{M} \rightarrow \text{L}$  if the metal is easily oxidized, whereas the transfer will be  $\text{L} \rightarrow \text{M}$  if the metal is easily reduced. Therefore, it is not surprising that Cr 0 in  $\text{Cr}(\text{CO})_6$  would have electron density shifted *from the metal to the ligands* and  $\text{Mn}_7^-$  would have electron density shifted *from the ligands to the metal*. The ease with which electron density can be shifted from the ligands to the metal is related in a general way to how difficult it is to ionize or polarize the ligands. We have not yet addressed the important topic of absorption by the ligands in complexes. For many types of complexes, this type of spectral study (usually infrared spectroscopy) yields useful information regarding the structure and details of the bonding in the complexes. This topic will be discussed later in connection with several types of complexes containing specific ligands (e.g.,  $\text{CO}$ ,  $\text{CN}^-$ ,  $\text{NO}^{2-}$  and olefins).

### (A) LMCT Transitions

Charge transfer (CT) transitions involve the movement of a charge from one atom to another during the electronic transition. In d-d transitions, the electron goes from one metalcation based molecular orbital to another metal-cation based MO; the electron stays practically on the same atom. If an electron resides in an MO that is primarily located on the ligand and gets excited to an MO that is metal-cation

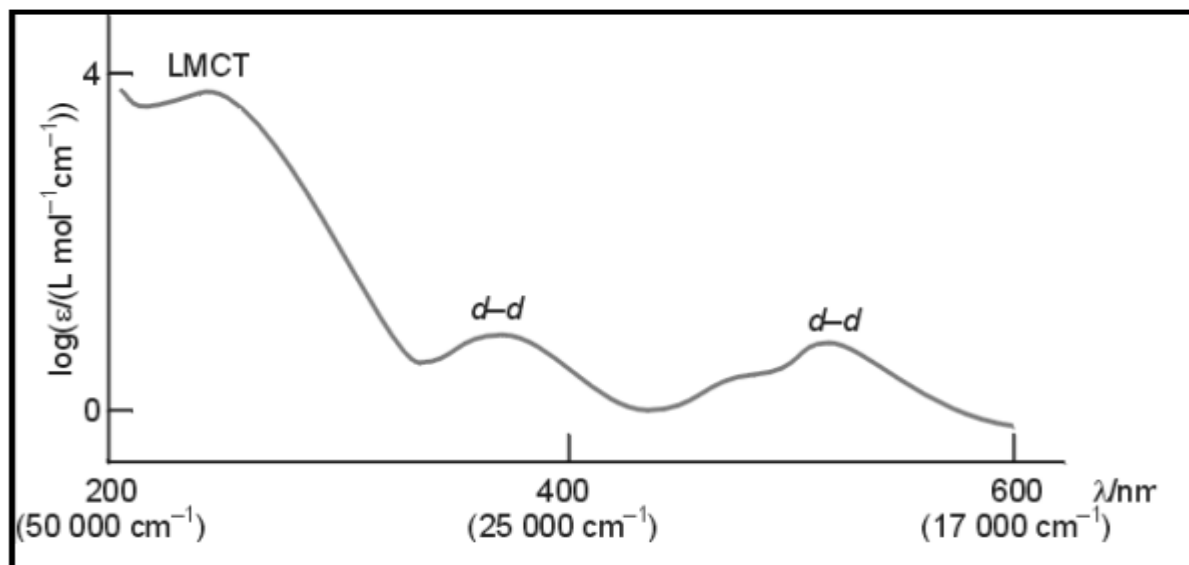



based, we talk about a ligand to metal charge transfer transition. In the figure on the left-hand side, LMCT transitions are depicted for an octahedral complex that start from a bonding ligand MO and end in one of the d orbital sets,  $t_{2g}$  or  $e_g$ . Such transitions are usually very intense and give rise to a deep coloration. An example for a LMCT band is found in the absorption spectrum of  $[\text{Cr}(\text{NH}_3)_5\text{Cl}]^{2+}$ :

An electron in the MO, that represents the lone pair on chlorine can be excited into a metal-based molecular orbital. As you can see in the spectrum, the LMCT band is much stronger than the d-d bands. The permanganate ion,  $\text{MnO}_4^-$ , is intensely coloured.

The reason for this coloration cannot be attributed to d-d transitions, since manganese does not have any d-electrons left. The purple colour is a result of a LMCT transition in which the oxygen lone-pair electron is promoted into a low-lying e metal orbital.

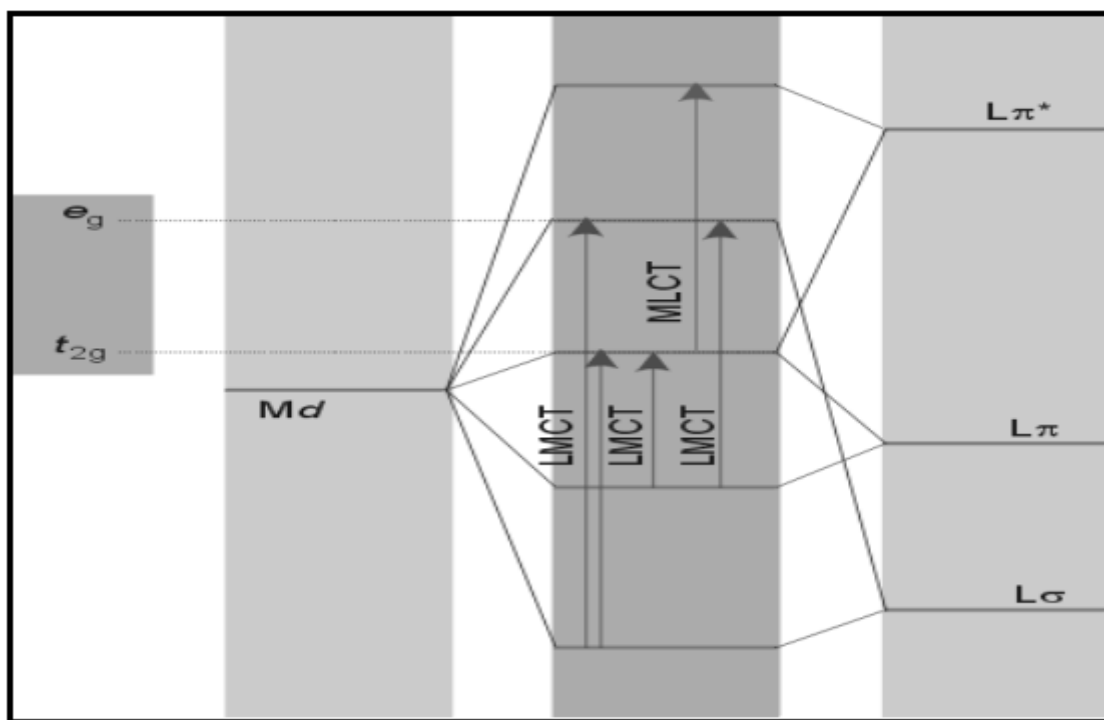

**LMCT- Transition**



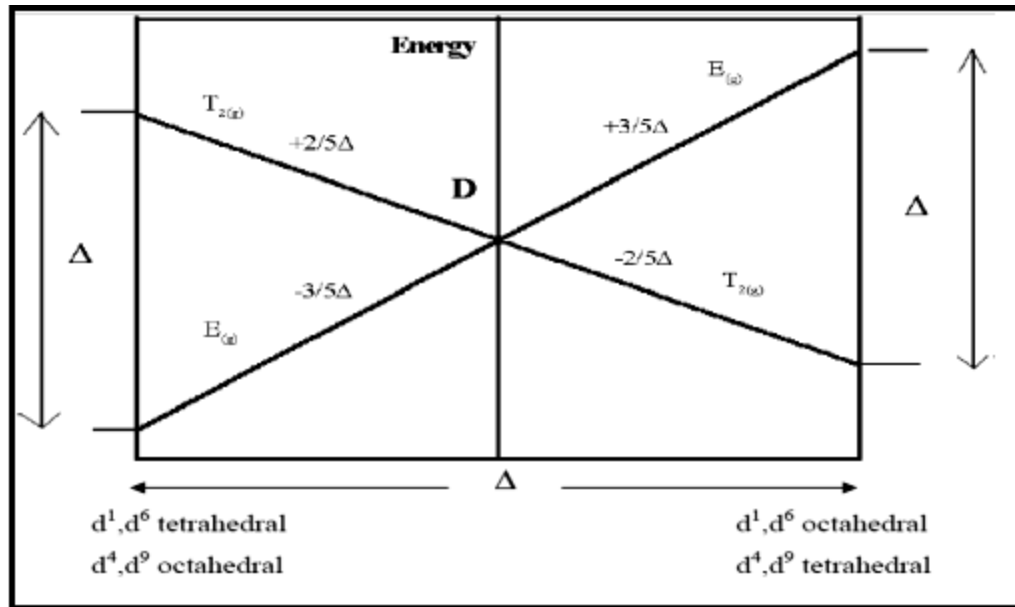

The splitting of free-ion D terms in octahedral and tetrahedral fields.

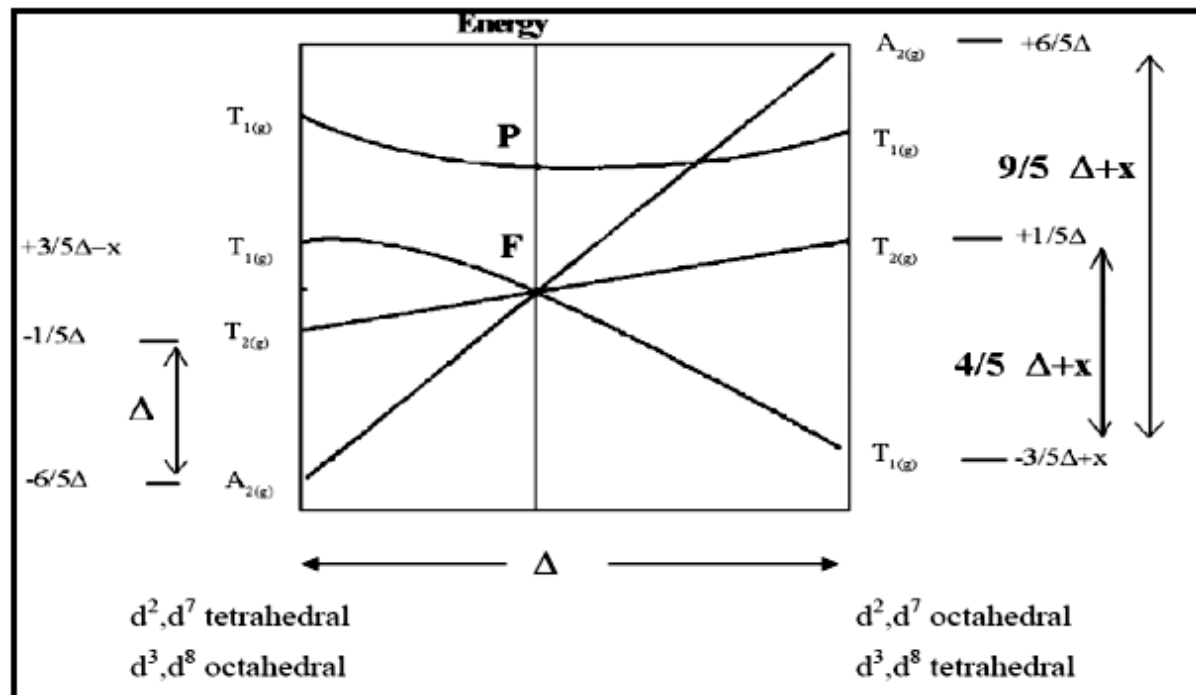

The splitting of free-ion F and P terms in octahedral and tetrahedral fields.



ligands to cause a large splitting of the energy between the orbitals is essentially independent of the metal ion and the spectrochemical series is a list of ligands ranked in order of their ability to cause large orbital separations. A shortened list includes:

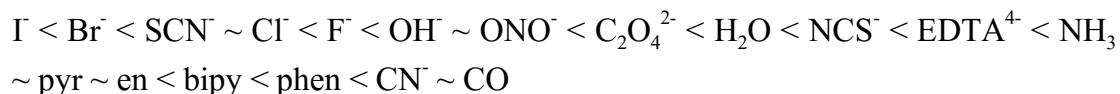

When metal ions that have between 4 and 7 electrons in the d orbitals form octahedral compounds, two possible electron allocations can occur. These are referred to as either weak field - strong field or high spin - low spin configurations.

### ❖ Nephelauxetic effect

The **Nephelauxetic effect** is a term used in the physical chemistry of transition metals. It refers to a decrease in the Racah interelectronic repulsion parameter, given the symbol  $B$ , that occurs when a transition-metal free ion forms a complex with ligands. The name "nephelauxetic" comes from the Greek for *cloud-expanding*. The presence of this effect brings out the disadvantages of Crystal Field Theory, as this accounts for somewhat covalent character in the metal-metal interaction.

The decrease in  $B$  indicates that in a complex there is less repulsion between the two electrons in a given doubly-occupied metal  $d$ -orbital than there is in the respective  $\text{M}^{n+}$  gaseous metal ion, which in turn implies that the size of the orbital is larger in the complex. This electron cloud expansion effect may occur for one (or both) of two reasons:

1. The effective positive charge on the metal has decreased. Because the positive charge of the metal is reduced by any negative charge on the ligands, the  $d$ -orbitals can expand slightly.
2. The act of overlapping with ligand orbitals and forming covalent bonds increases orbital size, because the resulting molecular orbital is formed from two atomic orbitals. The reduction of  $B$  from its free ion value is normally reported in terms of the nephelauxetic parameter,  $\beta$

$$\beta = B(\text{complex}) / B(\text{free ion})$$

Experimentally, it is observed that size of the nephelauxetic parameter always follows a certain trend with respect to the nature of the ligands present, shown below:



Although parts of this series may seem quite similar to the spectrochemical series of ligands - for example, cyanide, ethylenediamine, and fluoride seem to occupy similar positions in the two - others such as chloride, iodide and bromide (amongst others), occupy very different positions. The ordering roughly reflects the ability of the ligands to form good covalent bonds with metals - those that do not have a very small effect and are at the start of the series, whereas those that do are at the end.

The nephelauxetic effect does not only depend upon the ligand type, but also upon the central metal ion. These too can be arranged in order of increasing nephelauxetic effect as follows:

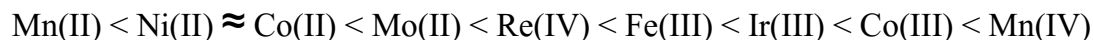

## 18.11 Racah parameters

We should expect a maximum of three spin-allowed transitions regardless of the  $d$   $n$  configuration of the metal ion. Because of spin-orbit coupling, the interelectronic repulsion is different for the various spectroscopic states in the ligand field. The ability of the electrons to be permuted among a set of degenerate orbitals and inter electron repulsion are both important considerations. By use of quantum-mechanical procedures, these energies can be expressed as integrals. One of the methods makes use of integrals that are known as the Racah parameters. There are three parameters,  $A$ ,  $B$ , and  $C$ , but if only *differences* in energies are considered, the parameter  $A$  is not needed. The parameters  $B$  and  $C$  are related to the coulombic and exchange energies, respectively, that are a result of electron pairing. For an ion that has a  $d^2$  configuration, it can be shown that the  ${}^3F$  state has an energy that can be expressed as  $(A - 8B)$ , whereas that of the  ${}^3P$  state is  $(A - 7B)$ . Accordingly, the difference in energy between the two states can be expressed in

terms of  $B$  only because the parameter  $A$  cancels. When states having a different multiplicity than the ground state are considered, the difference in energy is expressed in terms of both  $B$  and  $C$ .

When *complexes* of the metal ions are considered, the situation is considerably more complicated. The differences between energy states in the ligand field are related not only to the Racah parameters, but also to the magnitude of  $\Delta$  (or  $Dq$ ). As a result, the energies for the three spectral bands must be expressed in terms of both  $Dq$  and the Racah parameters. Because the observed spectral bands represent differences in energies between states having the same multiplicity, only the Racah  $B$  parameter is necessary. Even so,  $B$  is not a constant because it varies with the magnitude of the effect of the ligands on the  $d$  orbitals of the metal (the ligand field splitting). Analysis of the spectrum for a complex involves determining the value of  $Dq$  and  $B$  for *that complex*. Of course  $\Delta = 10Dq$ , and we have used  $\Delta$  to describe orbital splitting more frequently up to this point. When dealing with spectral analysis, the discussion can also be presented with regard to  $Dq$ .

Racah parameters  $B$  and  $C$  for a metal ion are variables whose exact values depend on the nature of the ligands attached to the ion. The change in  $B$  from the free ion value is expressed as the *nephelauxetic ratio*,  $\beta$ , which is given by

$$\beta = B/B_0$$

Where  $B_0$  is the Racah parameter for the free metal ion and  $B$  is the same parameter for the metal ion in the complex.

---

## 18.12 Summary

---

**This Chapter increase the knowledge of Electronic spectra of complexes, Jablonski diagram, Molecular emission spectra, Transitions absorption spectra, Spectrochemical Series & Nephelauxetic effect as well as Understand about Electronic spectra of Transition Metal Ions complexes.**

---

### **18.13 Review Question**

---

**Define molecular emission spectra of transition metal ions complexes?**

**What is Spectrochemical Series & Nephelauxetic effect?**

1. What are transition absorption spectra?
  2. Explain the Jablonski diagram?
- 

### **18.14 Reference and Suggested readings**

---

1. Cotton, F. A., Wilkinson, G., Murillo, C. A., and Bochmann, M. (1999). *Advanced Inorganic Chemistry*, 6th ed. Wiley, New York
2. Ballhausen, C. J. (1979). *Molecular Electronic Structure of Transition Metal Complexes*. McGraw-Hill, New York.
3. Chemistry of the First Row Transition Metal Complexes. C21J Inorganic Chemistry.
4. "Complexes and First-Row Transition Elements", Nicholls



---

# Unit – 19 : Magnetic properties of complexes

---

## Structure of Unit:

- 19.0 Objectives
- 19.1 Introduction
- 19.2 Magnetic Properties of Complexes- Paramagnetism
- 19.3 1st & 2nd Ordered Zeeman effect
- 19.4 Quenching of orbital angular momentum by Ligand fields
- 19.5 Magnetic properties of A, E & T ground terms in complexes
- 19.6 Spin free - spin paired equilibria
- 19.7 Summary
- 19.8 Review Question
- 19.9 Reference and Suggested readings

---

## 19.0 Objectives

---

At the end of the unit learner will be able to

- Learn about magnetic properties of complexes.
- Understand about paramagnetism, diamagnetism, ferromagnetism etc.
- Learn about Zeeman splitting and its effects.
- Quenching of orbital angular momentum.
- Understand the magnetic properties of A, E & T ground terms in complexes and spin equilibria.

---

## 19.1 Introduction

---

Magnetic properties can be determined by looking at a compound's electron configuration and the size of its atoms. Since Magnetism is created by the spin of electrons, we can look at how many unpaired electrons are present in a specific compound and determine how magnetic the compound is. For this purpose we will be evaluating the d-block elements or Transition Metals\* (TMs) because they tend to have a large number of unpaired electrons. This unit deals with the applications of ligand field theory of complexes with special reference to magnetic properties of complexes. The unit explains fundamental of magnetism with mathematical background. The unit also describes the Zeeman splitting and its mathematical derivations alongwith these units explains the state of quenching of orbital angular momentum, ground state terms and their magnetic properties. And then lastly unit briefly describes about spin equilibria.

---

## 19.2 Magnetic Properties of Complexes- Paramagnetism

---

Magnetic properties can be determined by looking at a compound's electron configuration and the size of its atoms. Since Magnetism is created by the spin of electrons, we can look at how many unpaired electrons are present in a specific compound and determine how magnetic the compound is. For this purpose we will be evaluating the d-block elements or Transition Metals\* (TMs) because they tend to have a large number of unpaired electrons.

The magnetism discussed in this chapter is paramagnetism, which occurs when there are one or more unpaired electrons in a compound. (The opposite, when all electrons are paired, is called diamagnetism). Di- and para-magnetism are often affected by the presence of coordination complexes, which the transition metals (d-block) readily form.

Singular electrons have a spin, denoted by the quantum number  $m_s$  as  $+(1/2)$  or  $-(1/2)$ . This spin is negated when the electron is paired with another, but creates a slight magnetic field when the electron is unpaired. The more unpaired electrons, the more likely paramagnetic a material is. The electron configuration of the

transition metals (d-block) changes when in a compound. This is due to the repulsive forces between electrons in the ligands and electrons in the compound. Depending on the strength of the ligand, the compound may become paramagnetic or diamagnetic.

Some paramagnetic compounds are capable of becoming ferromagnetic. This means that the compound shows permanent magnetic properties rather than exhibiting them only in the presence of a magnetic field. In a ferromagnetic element, electrons of atoms are grouped into domains, where each domain has the same charge. In the presence of a magnetic field, these domains line up so that charges are parallel throughout the entire compound. Whether a compound can be ferromagnetic or not depends on how many unpaired electrons it has and on its atomic size.

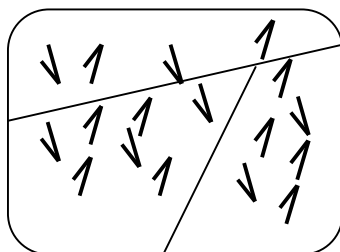

**Figure 19.1 (a) The atom's electrons are organized into Domains (in absence of magnetic field)**

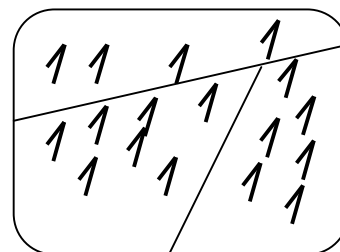

**Figure 19.1 (b) The atom's electrons are align in the same direction (in presence of magnetic field) the atom is ferromagnetic**

- Small atoms pair up too easily and their charges cancel.
- Large atoms are difficult to keep together, their charge interaction is too weak.

Therefore, only the right sized atoms will work together to group themselves into domains. Elements with the right size include: Fe, Co, Ni. That means that Fe, Co

and Ni are paramagnetic with the capability of permanent magnetism; they are also ferromagnetic.

### **Measurement of magnetism in a compound**

The Gouy balance is used to measure paramagnetism by suspending the complex in question against an equivalent weight with access to a magnetic field. We first weigh the complex without a magnetic field in its presence, then, we weigh it again in the presence of a magnetic field. If the compound is paramagnetic, it will be pulled visibly towards the electromagnet, which is the distance proportional to the magnitude of the compound's paramagnetism. If the compound, however, is diamagnetic, it will not be pulled towards the electromagnet, instead, it might even slightly be repelled by it. This will be proven by the decreased weight or the no change in weight. The change in weight directly corresponds to the amount of unpaired electrons in the compound.

### **Magnetic Properties relate to the "Real World"**

Ferromagnetism, the permanent magnetism associated with nickel, cobalt, and iron, appears throughout everyday life, Einstein declared that electricity and magnetism are inextricably linked in his theory of "special relativity." He also showed examples that a magnet can be disturbed by electricity.

Paramagnetism and diamagnetism explain and describe some of the properties of certain elements and complexes, which we work with on a regular basis. In the early days of complex-compound chemistry, paramagnetism was often used to help identify the shape of complexes. A technique known as electron paramagnetic resonance has been used in systems with certain para- and dia- magnetic properties to distinguish

### **Magnetic Properties of Complexes**

#### **Types of Magnetic Behaviour Fundamentals**

If a magnetic field,  $H$ , is applied to a substance the value of the field inside it,  $B$ , in general differs from that external to it. We write

$$\mathbf{B} = \mathbf{H} + \mathbf{I} \quad (1)$$

where  $I$  is the intensity of magnetization of the substance. For many substances  $I$  is colinear with  $H$  and proportional to it. Then  $B/H$  is a constant and may be expressed in the SI system as

$$\begin{aligned} B/H &= 1 + I/H \\ &= 1 + \chi \end{aligned} \quad (2)$$

$\chi$ , the ‘volume susceptibility’, is also a constant, usually of rather small value. It measures how susceptible the substance is to magnetization by the applied field. If  $\chi$  is negative the substance is said to be diamagnetic; if positive, paramagnetic or perhaps ferro- or antiferro-magnetic.

For some purposes, an alternative but equivalent definition of  $\chi$  is preferable. In general, the energy of the substance is altered by the presence of the field. If, for unit volume, the energy is  $W$ , we write

$$\chi = \frac{-\langle \mu \rangle}{H} \frac{dW}{dH} \quad (3)$$

where  $\langle \mu \rangle$  is the ‘magnetic moment’. In most cases the change in  $W$  is proportional to  $H^2$ , and again  $\chi$  is a constant.

The interaction of an electron, as charged particle, with an applied magnetic field causes a precession of its orbital motion which acts to cancel the field so that  $I$ , and hence  $\chi$  in equation 3 is negative. The effect is small but universal. The spin and angular momentum of an electron confer upon it the properties of a magnetic dipole, which tends to be oriented by the applied field, lowering the energy and making  $\chi$  positive (equation 3). This effect is larger than that due to electron charge, so the paramagnetism of an atom is larger than its diamagnetism. Net spin and angular momenta appear only for partly filled electron shells, and so paramagnetism is essentially a phenomenon of the transition, lanthanide and actinide elements. The charge-magnetic field interaction is independent of temperature, so that diamagnetism is essentially independent of temperature. The

energy of orientation of the atomic dipole by the magnetic field is usually less than the thermal energy available to the substance, so that its effects are temperature dependent. Paramagnetism is usually a temperature-dependent phenomenon. An ideal paramagnet obeys the *Curie law*

$$\chi = \frac{C}{T} \quad (4)$$

where C is the Curie constant. Since diamagnetism is omnipresent, this equation, in practice, must be modified to

$$\chi = \frac{C}{T} + \chi_{\text{diam}} \quad (5)$$

Few substances behave as ideal paramagnetics, even with allowance for the diamagnetic contribution of the second term in equation (5). It is found that a more practical expression for dealing with most: paramagnets is a variation of the Curie-Weiss Law

$$\chi = \frac{C}{T - \theta} + \chi_{\text{TIP}} + \chi_{\text{diam}} \quad (6)$$

Here,  $\theta$  is the Weiss constant and  $\chi_{\text{TIP}}$  is a temperature-independent paramagnetic contribution, often neglected as it may be even smaller than  $\chi_{\text{diam}}$ . For some purposes it is more convenient to deal with magnetic properties per unit mass rather than per unit volume. We define

$$\chi_{\text{m}} = \chi/\rho$$

where  $\rho$  is the density. Equations (3)-(6) all may be written replacing  $\chi$  by  $\chi_{\text{m}}$ . The units of  $\chi$  and  $\chi_{\text{m}}$  in the SI system are respectively  $\text{m}^3$  and  $\text{m}^3 \text{kg}^{-1}$ . In the c.g.s. system the quantities are related to the SI values by

$$\begin{aligned} \chi(\text{c.g.s.}) &= (4\pi)^{-1} \times 10^6 \chi \quad (\text{c.g.s.}) \text{ unit cm}^3 \\ \chi_{\text{m}}(\text{c.g.s.}) &= (4\pi)^{-1} \times 10^3 \chi_{\text{m}} \quad (\text{c.g.s.}) \text{ unit cm}^3 \text{g}^{-1} \end{aligned}$$

Diamagnetic susceptibilities are approximately  $\chi_{\text{mdiam}} = -0.5 \times 10^{-8} \text{ m}^3 \text{kg}^{-1}$ ; paramagnetic susceptibilities vary from zero to the order of  $10^{-5} \text{ m}^3 \text{kg}^{-1}$

---

## 19.3 1<sup>st</sup> & 2<sup>nd</sup> Ordered Zeeman effect

---

### **Zeeman effect**

Zeeman effect, the splitting of the lines in a spectrum into a group of closely spaced lines when the substance producing the single line is subjected to a uniform magnetic field. The effect was discovered in 1896 by the Dutch physicist Pieter Zeeman. In the so-called normal Zeeman effect, the spectral line corresponding to the original frequency of the light (in the absence of the magnetic field) appears with two other lines arranged symmetrically on either side of the original line. In the anomalous Zeeman effect (which is actually more common than the normal effect), several lines appear, forming a complex pattern. The normal Zeeman effect was successfully explained by H. A. Lorentz using the laws of classical physics (Zeeman and Lorentz shared the 1902 Nobel Prize in Physics). The anomalous Zeeman effect could not be explained using classical physics; the development of the quantum theory and the discovery of the electron's intrinsic spin led to a satisfactory explanation. According to the quantum theory all spectral lines arise from transitions of electrons between different allowed energy levels within the atom, the frequency of the spectral line being proportional to the energy difference between the initial and final levels. Because of its intrinsic spin, the electron has a magnetic field associated with it. When an external magnetic field is applied, the electron's magnetic field may assume only certain alignments. Slight differences in energy are associated with these different orientations, so that what was once a single energy level becomes three or more. Practical applications based on the Zeeman effect include spectral analysis and measurement of magnetic field strength. Since the separation of the components of the spectral line is proportional to the field strength, the Zeeman effect is particularly useful where the magnetic field cannot be measured by more direct methods.

### **High magnetic fields( 1<sup>st</sup> order and 2<sup>nd</sup> order Zeeman effect)**

The linearity of  $I$  in equation (2) with  $H$ , which gives  $\chi$  as constant in the case of paramagnetics, only holds so long as the orienting effects of the magnetic field on the atomic dipoles is very much less than the disordering effects of temperature. If

the magnetic field is strong enough, or the temperature low enough,  $\chi$  becomes field dependent. The relationship  $g\beta H \gg kT$  is necessary for linearity in equation (2), where  $\beta$  is the Bohr magneton and  $k$  the Boltzmann constant;  $g$  is a number defined in Figure 19.2. If magnetic exchange is present its orienting effects must also be considered. For  $g = 2$ , a common situation, and  $H = 1$  T,  $g\beta H = 1.44$  K. For an ideal paramagnet which obeys the Curie law at low magnetic field strengths the solution of the problem at  $g\beta H \sim kT$  available in closed form. It is convenient to formulate the situation in terms of the magnetization,  $M = \chi_m H$ , rather than of  $\chi$ . Then

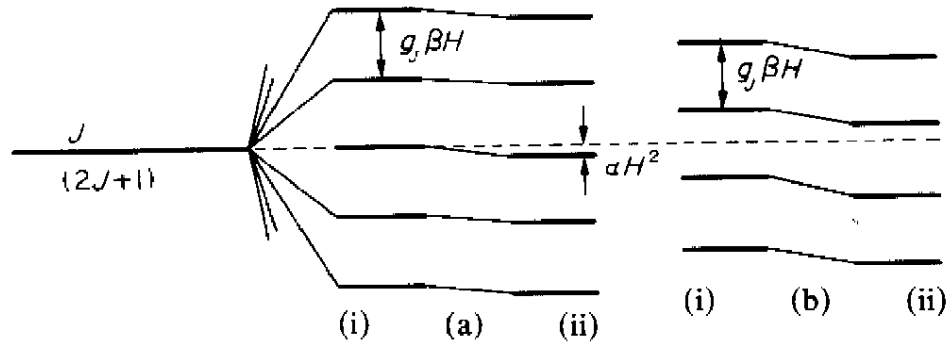

Figure 19.2 Splitting of a free-ion state into  $2J+1$  components by a magnetic field (a) for  $J$  even, (b) for  $J$  odd: (i) for the first-order Zeeman effect; (ii) including the second-order Zeeman effect

$$\begin{aligned}
 M &= g\beta S B(S, a) \\
 &= g\beta S \left[ \frac{2S+1}{2S} \coth\left(\frac{2S+1}{2S} a\right) + \frac{1}{2S} \coth\left(\frac{a}{2S}\right) \right] \quad (7)
 \end{aligned}$$

with  $S$  the spin quantum number from the paramagnetic atom,  $a = g\beta H/kT$  and  $B(S, a)$  is the Brillouin function.



## Quantities for chemical applications

The measurement  $\chi$  or  $\chi_m$  or perhaps  $M$ , is the one usually carried out. For chemical applications it is usual to relate these to more relevant quantities. The molar susceptibility,  $\chi_M$ , is

$$\chi_M = \chi(MV) = \chi_m(MW)$$

where  $MV$  and  $MW$  are the molecular volume and mass respectively. Further, in most applications only the paramagnetism of a single atom amongst many diamagnetic atoms is of interest. A correction for the diamagnetism of other atoms is made to give the atomic paramagnetism of the transition metal, lanthanide or actinide atom:

$$\chi_A = \chi_M - \sum_{\substack{\text{molecule} \\ i = \text{other atoms}}} \chi_{A_i} \quad (8)$$

where,  $\chi_{A_i}$  is the atomic diamagnetism, including covalent bonding contributions, of the ligands and counterions, if present. Atomic diamagnetic susceptibilities are of the order of  $2 \times 10^{-10} \text{ m}^3 \text{ mol}^{-1}$ ; atomic paramagnetic susceptibilities, at ambient temperature, range up to  $3 \times 10^{-7} \text{ m}^3 \text{ mol}^{-1}$ .

If the Curie law is obeyed,  $\mu_{\text{eff}}$  is not dependent on the temperature. If,  $\chi_A$  is expressed in c.g.s. units the number in equation (8) is 2.84 rather than 797.5. Mostly, of course, the Curie law is not obeyed accurately. A form of equation (6) is usually sufficient to describe magnetic behaviour except at the lowest of temperatures or if the magnetic exchange is strong

In such a case  $\mu_{\text{eff}}$  does depend upon temperature although the change is small unless  $\Theta$  is large, usually indicating strong magnetic exchange, or  $\chi_A$  (TIP) is large, a rare situation. If it is known that  $\Theta$  arises mainly from magnetic exchange it may be useful to derive, ignoring the  $\chi_A$  (TIP):

$$\mu'_{\text{eff}} = 797.5 [\chi_A(T-\theta)]^{1/2} \quad (9)$$

which will be less dependent on temperature and may be properly related to the value of  $\mu_{\text{eff}}$  for the system in the absence of magnetic exchange. However, if  $\theta$  arises from causes other than magnetic exchange, this procedure will be misleading and will obscure important facets of magnetic behavior.

---

## 19.4 Quenching of orbital angular momentum by Ligand fields

---

### Orbital contribution to magnetic moments

From a quantum mechanics viewpoint, the magnetic moment is dependent on both spin and orbital angular momentum contributions. The spin-only formula used last year was given as:

$$\mu_{\text{s.o.}} = \sqrt{4S(S+1)}$$

and this can be modified to include the orbital angular momentum

$$\mu_{\text{S+L}} = \sqrt{4S(S+1) + L(L+1)}$$

An orbital angular momentum contribution is expected when the ground term is triply degenerate i.e. a T state. These show dependency on temperature as well.

In order for an electron to contribute to the orbital angular momentum the orbital in which it resides must be able to transform into an exactly identical and degenerate orbital by a simple rotation (it is the rotation of the electrons that induces the orbital contribution). For example, in an octahedral complex the degenerate  $t_{2g}$  set of orbitals (dxz, dyx, dyz) can be interconverted by a 90 degree rotation. However the orbitals in the eg subset ( $dz^2, dx^2-y^2$ ) cannot be interconverted by rotation about any axis as the orbital shapes are different; therefore an electron in the eg set does not contribute to the orbital angular momentum and is said to be quenched. In the free ion case the electrons can be transformed between any of the orbitals as they are all degenerate, but there will still be partial orbital quenching as the orbitals are not identical. Electrons in the  $t_{2g}$  set do not always contribute to the orbital angular moment. For example in the  $d^3, t_{2g}^3$  case, an electron in the dxz orbital cannot by rotation be placed in the dyz orbital as the orbital already has an electron of the

same spin. This process is also called quenching. Tetrahedral complexes can be treated in a similar way with the exception that we fill the e orbitals first, and the electrons in these do not contribute to the orbital angular momentum.

### Quenching of Orbital Angular Momentum

When a free ion is subject to a ligand field there is generally a restriction of the number of orbitals of the same energy available to an electron without changing its spin. For example, the single electron of d1 in the free ion can occupy any of the five d-orbitals of a transition metal, but in the presence of an octahedral ligand field has only the planes of three of the  $t_{2g}$  set available. This restriction manifests itself as a reduction in the orbital angular momentum associated with the system. In place of  $L = 2$  for a free ion d-electron it can have an effective angular momentum  $L' = 1$  in a  $t_{2(g)}$  orbital set, and none in an  $e_{(g)}$  set ( $L' = 0$ ). The orbital angular momentum is said to be quenched by the ligand field. For a filled or half-filled  $t_{2(g)}$  subshell the net value of  $L$  is zero, just as it is for  $d^{10}$  or  $d^5$  in the free ion. Using the above arguments it is possible to derive for what strong-field configurations orbital angular momentum is partially or, nominally at any rate, fully quenched. As a generalization, it is seen that orbital angular momentum is quenched ( $L = 0$ ) for transition metal ions giving A or E ground terms, and partially quenched ( $L = 1$ ) for those giving T ground terms.

In practice, because of spin-orbit coupling, the quenching is not as complete. Spin-orbit coupling acts to mix in higher configurations with orbital angular momentum into the ground term. The effect takes two different forms according to the type of ground term.

For the  $A_{2(g)}$  and  $E_{(g)}$  ground terms,  $L$  remains zero but the g-value is changed from the spin-only value by an amount which decreases with increasing ligand field magnitude as follows:

$$\begin{array}{ll} A_{2(g)} & g = 2(1 - 4\lambda/\Delta) \\ E_{(g)} & g = 2(1 - 2\lambda/\Delta) \end{array} \quad (10)$$

For  $A_{1(g)}$  ground terms, which arise only from  $d^5$ ,  $g$  remains at 2.00 as there is no higher term of the same multiplicity. The spin-orbit coupling mixing of  $T_{1(g)}$  terms

acts to increase the effective value of  $L, L'$ , from 1 to as much as 1.5, depending on the relationship between the magnitudes of the ligand field and of the interelectronic repulsions. For the lanthanide elements, ligand field splittings are so small that quenching of orbital angular momentum is not important. This probability also applies in the actinide elements.

---

## 19.5 Magnetic properties of A, E & T ground terms in complexes

---

### Magnetic Properties of Atomic Systems

#### The Van Vleck equation

The ground term of a free atom or ion is  $(2L + 1)(2S + 1)$ -fold degenerate. This degeneracy is lifted in various ways, including by the action of spin-orbit coupling and ligand fields. The energy corresponding to each component of the term is also a function of the applied magnetic field. If we write for the  $i$ th wave function of the atom

$$W_i = W_i^0 + W_i^1 H + W_i^{\text{II}} H^2 + \dots \quad (11)$$

it can be shown that for laboratory scale fields terms after  $W^{\text{II}} H^2$  are negligibly small, and further that  $W_i^1 H$  and  $W_i^{\text{II}} H^2$  are  $\ll kT$  in magnitude except at very low temperatures. Then the average energy for the atom is obtained as the partition function

$$\bar{W} = \frac{\sum_i W_i \exp(W_i/kT)}{\sum_i \exp(W_i/kT)} \quad (12)$$

The magnetic moment  $\langle \mu \rangle$  for a state  $i$  may be identified with the matrix element  $\langle \psi_i | L_j + 2S_j | \psi_i \rangle$ , where  $j = x, y$  or  $z$ . With the use of equation (3) and the simplification of the exponentials because  $W_i^1/kT \ll 1$  and  $W_i^{\text{II}}/kT \ll 1$ , neglecting diamagnetism and multiplying by Avogadro's number, the result

$$\chi_A = N \sum_i [W_i^1/kT - 2W_i^{\text{II}}] \exp(W_i^0/kT) / \sum_i \exp(W_i^0/kT) \quad (13)$$

is obtained. This is the Van Vleck equation and is the basis of the calculation of the magnetic properties of atomic systems in ordinary circumstances. The first- and second-order Zeeman effect coefficients in the expansion of equation (9) are defined by the quantum numbers which specify the atomic energy level. They are in general a function of the direction of the magnetic field with respect to the axis of quantization of the wave

functions. They are obtained by the use of the magnetic moment operator for the appropriate direction,  $q = x, y$  or  $z$ :

$$\begin{aligned} W_i^I(q) &= \langle \psi_i | L_q + 2S_q | \psi_i \rangle \beta \\ W_i^{II}(q) &= \sum_j [\langle \psi_i | L_q + 2S_q | \psi_j \rangle^2 \beta^2 / (W_i^0 - W_j^0)] \end{aligned} \quad (14)$$

Of course,  $\chi_A$  is correspondingly also a function of the direction of the magnetic field.

Most usually, the atomic wave functions are specified by the quantum number set  $L, ML, S, Ms$  and are thus eigenfunctions of  $L_z$  and  $S_z$ , making the evaluation of the matrix elements and then of the susceptibility in that direction facile.

### Free-atom states and terms

If a free-atom state is subject to a magnetic field the  $(2J + 1)$ -fold degeneracy is lifted so that, as shown in Figure 19.2, each level specified by the quantum number  $M_j$  is separated from its neighbour by the amount  $g_j \beta H$ , where  $g_j$  is the spectroscopic splitting factor. The value of  $g$  can be calculated from knowledge of the term from which the state arise.

$$g_f = 1 + [S(S + 1) - L(L + 1) + J(J + 1)] / 2J(J + 1) \quad (15)$$

Note that if  $L = 0$  in equation (15) then  $J = S$  and  $g = 2$ , the 'spin-only-value'. The energy pattern of Figure 19.2 is linear in  $H$ : there is no second-order Zeeman effect unless other states are considered. Application of equation (12) to this system is fairly straightforward since it yields

$$\chi_A = \frac{N\beta^2}{3kT} g_J^2 J(J+1) \quad (16)$$

And hence

$$\mu_{\text{eff}} = g_J [J(J+1)]^{1/2} \quad (17)$$

Equations (16) and (17) apply quite well to the majority of the lanthanide element compounds, where the approximation to an isolated ground state is good.

If  $L=0$  then equations (16) and (17) reduce to the spin-only expressions  $\chi = 4(N\beta^2/3kT)S(S+1)$  and  $\mu_{\text{eff}} = 2[S(S+1)]^{1/2}$ , but it is more useful to regard these as special cases of equations (18) and (19) where  $g$  is close to, but not necessarily equal to, the spin-only value.

$$\chi_A = \frac{N\beta^2}{3kT} g^2 S(S+1) \quad (18)$$

$$\mu_{\text{eff}} = g[S(S+1)]^{1/2} \quad (19)$$

For a state showing only the first-order Zeeman effect the magnetization as a function of field strength is given by the Brillouin function (equation 7). For two of the lanthanide  $M^{3+}$  ions, equations (16) and (17) do not hold. They are  $\text{Eu}^{3+}$ ,  $f^6(^7F_0)$ , and  $\text{Sm}^{3+}$ ,  $f^5(^6F_{2/2})$ , here another state lies fairly close above the ground state which then cannot be considered in isolation. For the  $^7F_0$  state,  $J=0$  and  $\chi_{\text{Eu}}$  and  $\mu_{\text{eff}}$  are predicted to be zero. In fact,  $\chi_{\text{Eu}} \sim 100 \text{ m}^3 \text{ mol}^{-1}$  independent of temperature. This effect arises because the  $^7F_1$  state, a few hundred  $\text{cm}^{-1}$  higher, interacts with the ground state to give substantial second-order Zeeman effect terms  $W_i H^2$  in equations (12) and (13) and, as there is no first-order term and the higher state lies  $\ll kT$ , it is seen that equation (12) tends to a temperature independent susceptibility. For  $\text{Sm}^{3+}$  the position is more complicated as the ground  $^6H_{2/2}$  state has a first-order Zeeman term as well as a second-order one from the  $^6H_{3/2}$  state a few hundred  $\text{cm}^{-1}$  higher. Here, for temperatures such that the  $^6H_{3/2}$  state lies  $\ll kT$ ,

$$\chi_{Sm} = \frac{N\beta^2}{3kT} g^2 \frac{5}{2} \frac{7}{2} + N\alpha$$

where  $N\alpha$  is a temperature independent paramagnetic term (TIP). This is a specialized form of equation (20), which has some general applicability:

$$\chi_A = \frac{N\beta^2}{3kT} g^2 S(S+1) + N\alpha \quad (20)$$

and is a form of equation (6) with  $C = N \beta^2 g^2 S(S+1)/3kT$  and  $\theta = 0$ .

Although there is no ion for which spin-orbit coupling is so small that all states of the ground term lie  $\ll kT$  above the ground state, it is instructive to develop the expression for such a condition. The application of equation (13) gives

$$\mu_{\text{eff}} = [4S(S+1) + L(L+1)]^{1/2}$$

putting  $L = 0$  which gives the spin-only result of equation (19) again. For state separations of the order of  $kT$  the first- and second-order Zeeman effect coefficients for equation (13) are both important and the exponents vary with temperature; there results complicated expressions for the magnetic behaviour for which a general expression has been developed.

### A and E ground terms

The configurations corresponding to the  $A_1$  (free ion S term), E (free ion D term), or  $A_2$  (from F term) do not have a direct contribute to the orbital angular momentum.

For the  $A_2$  and E terms there is always a higher T term of the same multiplicity as the ground term which can affect the magnetic moment (usually by a only small amount).

$$\mu_{\text{eff}} = \mu_{\text{s.o.}} (1 - \alpha \lambda / \Delta)$$

where  $\alpha$  is a constant (2 for an E term, 4 for an  $A_2$  term)  $\lambda$  is the spin-orbit coupling constant which is generally only available for the free ion but this does give important information since the sign of the value varies depending on the orbital occupancy.

some spin-orbit coupling constants for 1st row transition metal ions								
metal ion	Ti(III)	V(III)	Cr(III)	Mn(III)	Fe(II)	Co(II)	Ni(II)	Cu(II)
d configuration	1	2	3	4	6	7	8	9
$\lambda / \text{cm}^{-1}$	155	105	90	88	-102	-172	-315	-830

for  $d^1$  to  $d^4$  the value is positive hence  $\mu_{\text{eff}}$  is less than  $\mu_{\text{s.o.}}$ . for  $d^6$  to  $d^9$  the value is negative hence  $\mu_{\text{eff}}$  is greater than  $\mu_{\text{s.o.}}$ .  $\Delta$  is the crystal field splitting factor which again is often not available for complexes. For the tetrahedral Co(II) ion,  $\text{CoCl}_4^{2-}$ , the observed experimental magnetic moment,  $\mu_{\text{obs}} = 4.59$  Bohr Magneton (B.M.) The spin-only magnetic moment,  $\mu_{\text{s.o.}} = 3.88$  B.M. which is not in good agreement. Since the ground term in the tetrahedral field is split from a  $^4F$  to a  $^4A_2$  term then we can apply the formula above. For an A term the constant  $\alpha = 4$ . The spin-orbit coupling constant,  $\lambda$  for the free ion is  $-172 \text{ cm}^{-1}$  which we can use as an approximation and  $\Delta = 3100 \text{ cm}^{-1}$ . Hence  $\mu_{\text{eff}} = 3.88 \times (1 - (4 \times -172) / 3100)$  which comes out at  $\mu_{\text{eff}} = 4.73$  B.M. This gives a much better fit than the spin-only formula. In the case of the series;  $\text{CoI}_4^{2-}$ ,  $\text{CoBr}_4^{2-}$ ,  $\text{CoCl}_4^{2-}$ ,  $\text{Co(NCS)}_4^{2-}$  the magnetic moments have been recorded as 4.77, 4.65, 4.59, 4.40 BM assuming that  $\lambda$  is roughly a constant, then this variation shows the inverse effect of the spectrochemical series on the magnetic moment, since  $\Delta$  is expected to increase from I- to NCS-.

### T ground terms

The configurations corresponding to the  $T_2$  term (from D) or a  $T_1$  term (from an F term) are those where there is a direct contribution to orbital angular momentum expected. The magnetic moments of complexes with T terms are often found to show considerable temperature dependence. This is as a result of spin-orbit coupling that produces levels whose energy differences are frequently of the



order  $kT$ , so as a result, temperature will have a direct effect on the population of the levels arising in the magnetic field. In a Kotani plot  $\mu_{\text{eff}}$  is plotted against  $kT/\lambda$  and when this corresponds to a value of 1 then  $\mu$  equals the "spin-only" value. If this is extrapolated to infinity then the value corresponds to  $\mu_{\text{S+L}}$ .

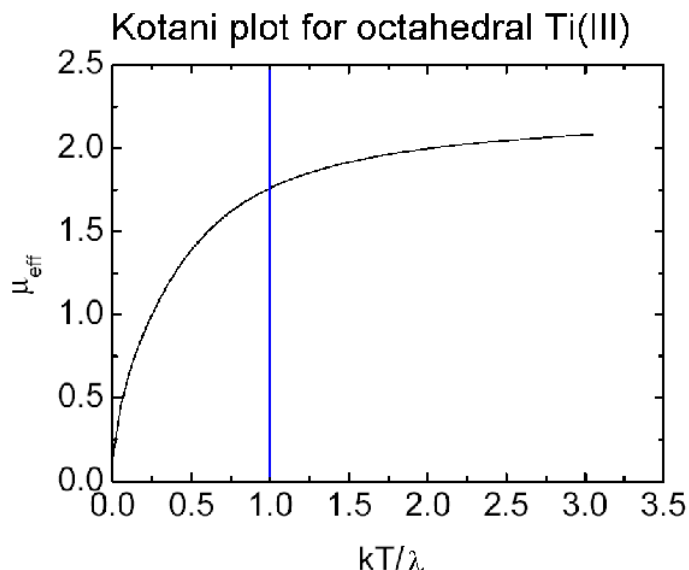

Measuring the magnetic moment at 80K and 300K often shows up this variation with temperature.

---

## 19.6 Spin free - spin paired equilibria

---

### Spin equilibria

If the relationship between the ligand field splittings and the interelectronic repulsions is of the critical value then the energy of the term of lower spin may be the same as that of the higher. Provided the equality is met within a few times the thermal energy available to the system, the energy levels corresponding to both terms will be occupied and the magnetic properties will contain contributions from each. In the simplest case of two states specified by  $S$ , and  $S_z$  and separated by an energy  $\Delta E_s$  one may write as a first approximation

$$\chi_A = \frac{(2S_1 + 1)\chi_A(S_1) + (2S_2 + 1)\chi_A(S_2) \exp(-\Delta E_S/kT)}{(2S_1 + 1) + (2S_2 + 1) \exp(-\Delta E_S/kT)} \quad (21)$$

However, each term may in fact cover a range of energies, corresponding to spin-orbit coupling, low-symmetry ligand field splitting and vibrational coupling, so that expressions a good deal more complex than equation (21) are required in practical situations. Further, the two spin states may not be independent. They may be coupled through the lattice, in that the occupation of the low-spin configuration usually corresponds to shorter metal-ligand bond lengths. Coupling of this type can result in cooperative phenomena, in which the occupation factors for the terms involved may change sharply with temperature rather than smoothly as required by thermal equilibrium. Again, the two terms may be connected by a matrix element of the spin-orbit coupling operator. Then, as they approach equality in energy, the concept of individual spin quantum numbers is no longer valid and the system is said to be in a mixed-spin state. The consideration of the magnetic behaviour of equilibrium systems in detail is a matter for individual attention, and cannot be elaborated further here.

## 19.7 Summary

In the unit given above the applications of ligand field theory of complexes with special reference to magnetic properties of complexes are discussed and also it explained fundamental of magnetism with mathematical back ground. The unit described the Zeeman splitting and its mathematical derivations alongwith these units explains the state of quenching of orbital angular momentum, groun state terms and their magnetic properties. And then lastly unit briefly describes about spin equilibria.

## 19.8 Review Question

1. Explain different magnetic behavior of complexes.
2. Describe Zeeman effect.
3. What is quenching of orbital angular momentum? Explain.

4. Discuss magnetic properties of A,E and T ground terms.
5. Give the Van Vleck equation.

---

## **19.9 Reference and Suggested readings**

---

1. Concise Inorganic chemistry- J.D. Lee (Blackwell Science) 2001
2. Advanced Inorganic Chemistry- J. March (Interscience publisher) 2008
3. Ligand field theory and its applications. B.N Figgis *et. al.*

---

# Unit-20 : Bioinorganic Chemistry

---

## Structure of Unit

- 20.0 Objective
- 20.1 Introduction
- 20.2 Overview of Bioinorganic Chemistry
- 20.3 Macromolecules
- 20.4 Proteins
- 20.5 Nucleic Acid
- 20.6 Metal binding Biomolecules
- 20.7 Summary
- 20.8 Review Questions
- 20.9 References and Suggested Readings

## 20.0 Objective

---

At the end of the unit learner will be able to

- Understand that what bioinorganic chemistry and molecules.
- Learn about the proteins and nucleic acid.
- Also take knowledge about metal bindingbiomoalecules.

---

## 20.1 Introduction

---

This unit deals with the Bioinorganic Chemistry which is the intermediate of inorganic chemistry and biochemistry, it describes the mutual relationship between these two sub-disciplines, with focus upon the function of inorganic “substances“ in living systems, including the transport, speciation and, eventually, mineralisation of inorganic materials, and including the use of inorganics in medicinal therapy and diagnosis. These “substances” can be metal ions (such as  $K^+$ , ferrous and ferric), composite ions (e.g. molybdate), coordination compounds

(like cisplatin and carbonyltechnetium), or inorganic molecules such as CO, NO, O<sub>3</sub>. And deals with the macromolecules which is a very large molecule that has a polypeptide chain structure. Proteins, rubber, genes, polysaccharides, and synthetic polymers all consist of macromolecules. Macromolecules interact with each other and with small molecules. All of the interactions reflect the complementary between the interacting species. Sometimes, the complementary is general, as in the association of hydrophobic groups, but more often an exact fit of size, shape and chemical affinity is involved. Then the unit describe deeply proteins and nucleic acid. And then it describe about metal binding Biomolecules i.e. **Calcium**, which is a critical element in all animals and man. A healthy human adult has about 1.05 kg Ca, of which 99% exists as phosphates resembling the mineral hydroxyapatite, Ca<sub>10</sub>(PO<sub>4</sub>)<sub>6</sub>(OH)<sub>2</sub>, in bones and teeth. **Magnesium**, which is an abundant element in the earth's crust, is vital to both plant and animal life. Chlorophyll pigment in plants is a Mg-porphyrin complex. All enzymatic reaction in animals and men that are catalyzed by ATP require Mg as a cofactor. **Potassium**, An adult human has approximately 140 g K of which >90% is both intracellular and exchangeable (K is the predominant cation in intracellular water) since muscle contains most of the body's intracellular water, it also contains most of the K. **Sodium**, Sodium is the predominant extracellular cation in animals and man. An adult human has about 105 g Na, about 24% is located in bone and about 65% in extracellular water. Sodium ion equilibrium is maintained primarily by the kidney, the key organ in water and electrolyte balance. **Cobalt**, Cobalt is an essential element for humans, but its pathway through the food chain to human being remain elusive. Only a little over 1 mg Co is present in an adult human. It is useful to man, insofar as is known, only in the form of vitamin B<sub>12</sub> (cobalamin). **Zinc**, An adult has about 1.5-3.0 g Zn with the largest amounts being in liver and bone. There is evidence that Zn concentrations in blood and several tissues vary considerably in response to many stimuli. Zinc appears to be critical in many functions. **Molybdenum**, The essentiality of Mo in animals and human beings is assumed from its presence in the metalloenzymes xanthine oxidase and aldehyde oxidase. Mo is also part of the enzyme sulphite oxidase, an inherited deficiency of which cause severe neurologic disorders and

early death in humans. **Chromium**, The designation of Cr as an element essential to animals and man is quite recent. Insofar as is known, the major biological function of Cr is an integral part of an organic complex originally isolated from yeast termed “glucose tolerance factor” (GTF). **Copper**, Normal adult human has about 100-110 mg Cu, highest concentrations are found liver, kidney, heart and brain. The prototype functional deficiency of Cu in humans is an X-linked inherited disorder called Menke’s syndrome (Kinky or steely hair syndrome). **Iron**, The average human adult has about 4-5 g Fe. Of this amount, about 60-70% is present in haemoglobin in red blood cell, 3-5% is in muscle myoglobin, 15% is bound to the Fe storage cellular protein, ferritin, 0.2% occurs as a component of critical respiratory enzymes and 0.004% is bound to the serum transport protein transferrin.

---

## 20.2 Overview of Bioinorganic Chemistry

---

“Bioinorganic Chemistry“ is at the gate-way of inorganic chemistry and biochemistry, i.e. it describes the mutual relationship between these two sub-disciplines, with focus upon the function of inorganic “substances“ in living systems, including the transport, speciation and, eventually, mineralisation of inorganic materials, and including the use of inorganics in medicinal therapy and diagnosis. These “substances” can be metal ions (such as  $K^+$ , ferrous and ferric), composite ions (e.g. molybdate), coordination compounds (like cisplatin and carbonyltechnetium), or inorganic molecules such as CO, NO, O<sub>3</sub>. Medicinal inorganic chemistry on the one hand, and biomineralisation on the other hand, are important integral parts. Inorganic reactions have possibly played an important role in the formation and development of organic “life molecules” in the prebiotic area (terrestrial and/or extraterrestrial), and from the very beginning of life on Earth. Inorganic chemistry is involved in structure and function of all life forms present nowadays on Earth, Life started ca 3.5 billion years ago with LUCA, the first uniform (and unknown) common ancestor. At that time, our planet was already covered by oceans. The overall situation was, however, completely different from that of today: The primordial atmosphere (also referred to as “primordial broth”) contained CO<sub>2</sub>, N<sub>2</sub> and H<sub>2</sub>O as the main components, and trace

amounts of gases like H<sub>2</sub>, CO, COS, H<sub>2</sub>S, NH<sub>3</sub> and CH<sub>4</sub> from volcanic exhalations, and trace amounts of oxygen from the decomposition of water by electric discharges, cosmic rays and radioactivity. The Earth's crust was essentially unstable due to wide-spread volcanism and bombardment by debris (meteorites), remainders from the constitution of the solar system some 4.5 billion years ago. A key reaction at that time was the conversion of ferrous sulfide to ferrous disulfide (pyrite, FeS<sub>2</sub>) (eqn. 1), accompanied by a reduction potential of -620 mV, enough to enable reductive carbon fixation, including reductive C-C coupling, and thus to allow entrance into the world of organic compounds. Eqns. (2) (formation of thiomethanol as a key compound) and (3) (formation of thioacetic acid) are examples. Of particular interest is the formation of “active acetic acid methylester” (eqn. 3b), which is an essential constituent of acetyl-coenzyme-A, a focal product in biological carbon cycling, the synthesis of which is catalysed by an acetylcoenzyme-M synthase, a iron-nickel-sulphur enzyme.

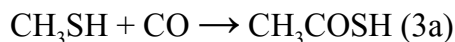

“Active acetic acid” readily reacts with amino acids (formed in the primordial broth by electric discharge; and/or in interstellar clouds by irradiation and carried to Earth confined in the ice cores of comets) to form peptides, which chiral selection and further polymerise on chiral matrices provided by certain clays and quartz minerals. Concomitantly, nucleobases can form under primordial and interstellar conditions, and polymerise to RNA, unique molecules which not only store information and transform this information into proteins, but also can act – like proteins – as enzymes (so-called ribozymes). The first life forms, primitive cellular organisms capable of self-sustenance and self-replication, are actually believed to have been members of an “RNA world”, which later has been replaced by our DNA world. Some of these inorganic elements, such as Fe, Cu and Zn,

are present in (practically) all organisms, others are important for a restricted number of organisms only. An additional group of elements are used for diagnostic or therapeutic applications.

### **Significance of biologically important elements**

$\text{Na}^+$  and  $\text{K}^+$ : Most important „free“ intra- and extracellular cations. Regulation of the osmotic pressure, membrane potentials, enzyme activity, signalling.

$\text{Mg}^{2+}$ : Chlorophyll; anaerobic energy metabolism ( $\text{ATP} \rightarrow \text{ATP}$ ).

$\text{Ca}^{2+}$ : Signalling, muscle contraction, enzyme regulation. Main inorganic part of the endoskeletons (bones, teeth, enamel: hydroxyapatite;  $\text{Ca}_5(\text{PO}_4)_3(\text{OH})$ ). Exoskeletons of mussels, shells, corals, sea urchins etc: aragonite or calcite;  $\text{CaCO}_3$ ).

Fe and Cu: Transport of oxygen.

FeIII: Iron-storage proteins (ferritins).

FeII + FeIII in magnetite ( $\text{Fe}_3\text{O}_4$ ): orientation of magnetobacteria, pigeons, bees in Earth's magnetic field.

Co: Synthases and isomerases (cobalamines, e.g. vitamin-B12); methylation of inorganics.

$\text{Zn}^{2+}$ : In the active centre of hydrolases, carboanhydrase, alcohol dehydrogenase, synthases; genetic transcription (zinc fingers), stabilisation of tertiary and quaternary structures of proteins; repair enzymes.

Cl<sup>-</sup>: Along with hydrogencarbonate the most important free anion.

I: Constituent of thyroid hormones (such as thyroxine).

---

## **20.3 Macromolecules**

---

A macromolecule is a very large molecule that has a polypeptide chain structure. Proteins, rubber, genes, polysaccharides, and synthetic polymers all consist of macromolecules. Macromolecules interact with each other and with small molecules. All of the interactions reflect the complementary between the interacting species. Sometimes, the complementary is general, as in the association



of hydrophobic groups, but more often an exact fit of size, shape and chemical affinity is involved.

Inorganic macromolecules can be divided into several categories such as solids formed due to covalent bonds, organosilanes, siloxanes and organosiloxanes. Inorganic molecules are generally simple and are not normally found in living things. Although all organic substances contain carbon, some substances containing carbon, such as diamonds, are considered inorganic.

---

## 20.4 Proteins

---

### Amino Acid Building Blocks

Polypeptides are formed through the polymerization of any combination of the 20 naturally occurring amino acids (aa). In humans, 10 of these amino acids are essential (cannot be synthesized by the body and must be ingested in the diet). The 10 essential amino acids (see Figures 20.1–20.4 for full names and structures) are: arg, his, ile, leu, lys, met, phe, thr, trp, and val. Relatively short amino acid chains, called polypeptides, have important hormonal (control) functions in biological species. Proteins are classified as polypeptide chains exceeding 50 amino acids in length, whereas enzyme molecules usually contain more than 100 amino acid residues. Amino acids contain a central carbon, called the  $\alpha$  carbon, to which four substituent groups are attached: the amine group ( $\text{NH}_2$ ), a carboxylic acid group ( $\text{COOH}$ ), a hydrogen atom ( $\text{H}$ ), and a side chain ( $\text{R}$ ) group unique to each amino acid. The structure of these basic building blocks are grouped in Figures 20.1 to 20.4 to indicate the neutral, polar, acidic, or basic characteristics of their  $\text{R}$  groups. The three- and one-letter common abbreviations for amino acids are shown in the figures. The amino acids are shown in their zwitterion form at pH 7 in which they have their  $\text{COOH}$  group ( $\text{pK}_a \approx 2.35$ ) in the  $\text{COO}^-$  form and their  $\text{NH}_2$  group ( $\text{pK}_a \approx 9.69$ ) in the  $\text{NH}_3^+$  form. Side-chain  $\text{R}$  groups will be protonated or deprotonated based on the  $\text{pK}$  value of the side chain. All amino acids found in proteins are called  $\alpha$ -amino acids because the amine group is bonded to the  $\alpha$  carbon. All amino acids found in proteins are L-stereoisomers with respect to the  $\alpha$  carbon (except glycine whose  $\text{R}$  group is  $\text{H}$ ), although D-stereoisomers are found

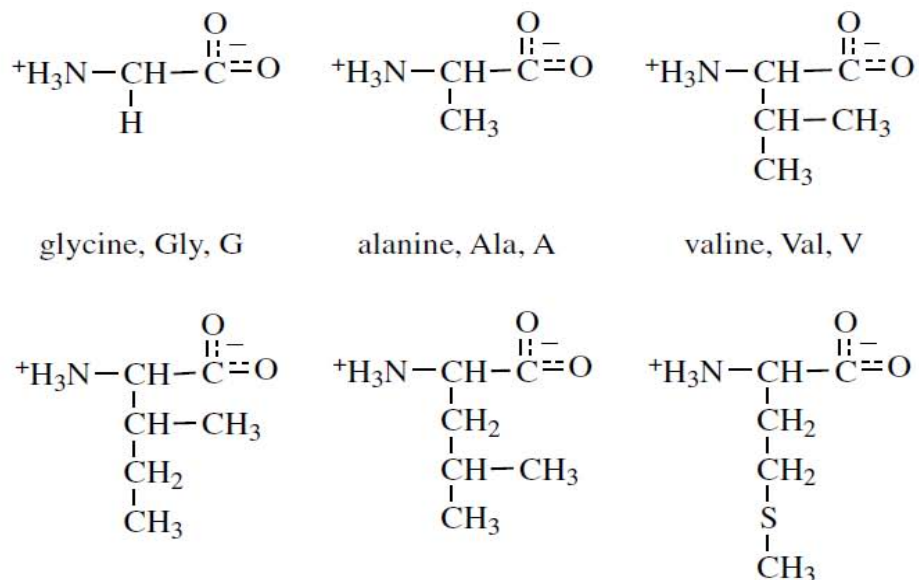

Figure - 201.

in bacterial cell walls and some peptide antibiotics. In nomenclature for amino acids as ligands, the atoms in the R group are labeled with Greek letters starting with b for the first atom attached to the  $\alpha$  carbon followed by g and d and e. The common bioinorganic ligands histidine, cysteine, and aspartic acid have their atoms labeled in the manner shown in Figure 20.5. The labeling becomes important in identifying the ligand atom, the possible metal binding site, in metalloproteins. In histidine, metals bind at either the d or e positions. In superoxide dismutase, his bridges the metal ions with Zn(II) coordinated at the d nitrogen and Cu(II) at the e nitrogen. In aspartic acid, metals may bind in monodentate mode (Asp-M), in bidentate chelate mode as shown in Figure 20.5, or in bidentate bridging mode (Asp-M2).

isoleucine, Ile, I

leucine, Leu, L

methionine, Met, M

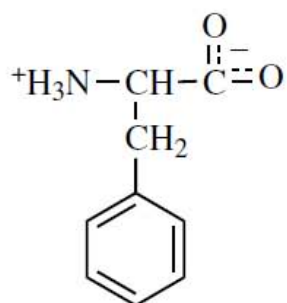

phenylalanine, Phe, F

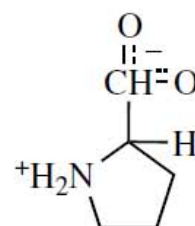

proline, Pro, P

**Figure 20.1 Zwitterions of nonpolar hydrophobic amino acids at physiological pH.**

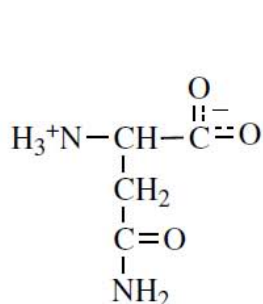

asparagine, Asn, N

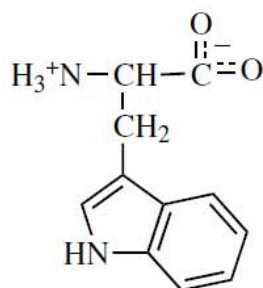

tryptophan, Trp, W

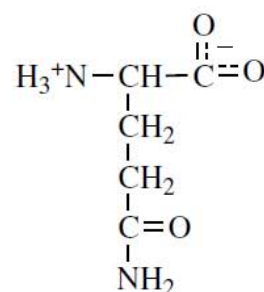

glutamine, Gln, Q

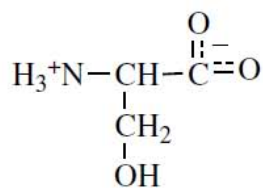

Serine, Ser, S

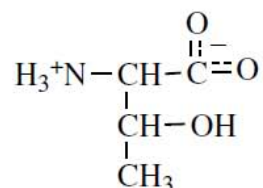

threonine, Thr, T

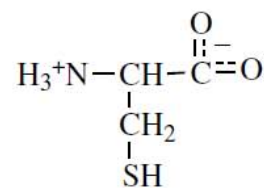

cysteine, Cys, C

**Figure 20.2 Zwitterions of polar neutral amino acids at physiological pH.**

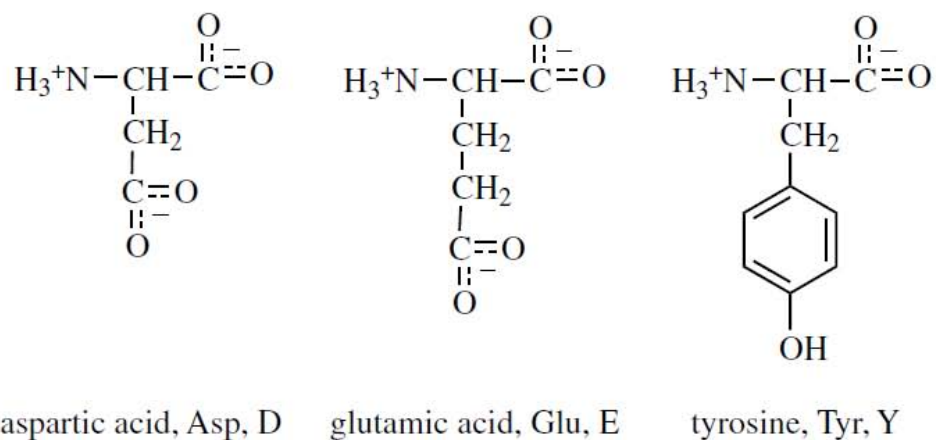

**Figure 20.3 Zwitterions of acidic amino acids at physiological pH.**

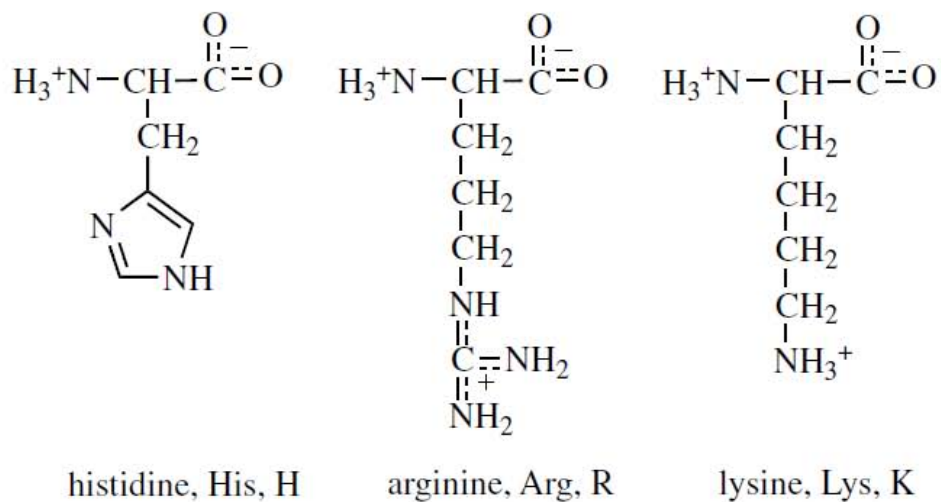

**Figure 20.4 Zwitterions of basic amino acids at physiological pH.**

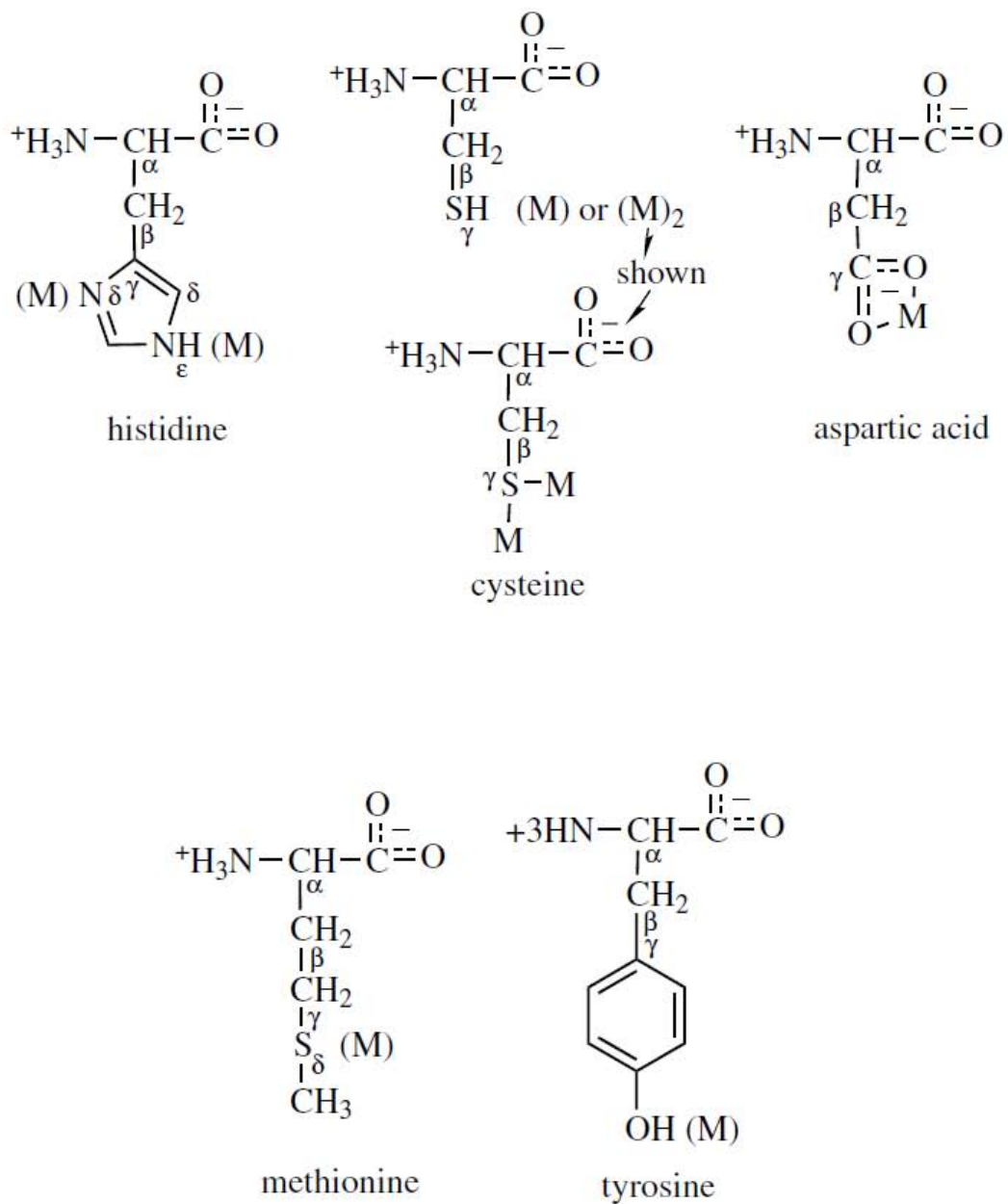

**Figure 20.5** Common metal ion bonding modes to amino acid residues in proteins.

## Protein Structure

All proteins have at least three levels of structure: primary, secondary, and tertiary. Proteins with more than one polypeptide chain—hemoglobin and nitrogenase are examples—also possess quaternary structure. The primary, secondary, tertiary, and quaternary structure of proteins control their three-dimensional shape, which, in turn, affects their activity.

The primary structure of proteins is formed by a condensation reaction forming a peptide bond. A water molecule is eliminated as each successive peptide bond is formed. The peptide bond is rigidly planar and has a bond length intermediate between a single and a double bond. This rigid bond forms the backbone of the protein. Other single bonds in a polypeptide chain are flexible and can rotate.

A protein's secondary structure arises from the formation of intra- and intermolecular hydrogen bonds. All carboxyl group oxygens and amine hydrogens of a polypeptide participate in H-bonding. Protein secondary structure also derives from the fact that although all C–N bonds in peptides have some double bond character and cannot rotate, rotation about the C<sub>α</sub>–N and C<sub>α</sub>–C bonds is possible.

The examples of protein's secondary structures are of  $\alpha$ -helix and  $\beta$ -pleated sheet.

The tertiary structure of proteins arises from the interactions of the various R groups along the polypeptide chain. Some of the forces responsible for the tertiary structures include van der Waals forces, ionic bonds, hydrophobic bonds, and hydrogen bonds. Usually, hydrophilic R groups arrange themselves on the exterior of the tertiary structure so as to interact with the aqueous environment, whereas hydrophobic R groups usually orient themselves on the interior of the protein's tertiary structure so as to exclude water. One ionic bond often found in establishing tertiary structure is a disulfide bond between two cysteine side-chain groups for example, in the copper enzyme azurin.

## Functions of Proteins

Protein is an important substance found in every cell in the human body. In fact, except for water, protein is the most abundant substance in your body. This protein is manufactured by your body utilizing the dietary protein you consume. It is used

in many vital processes and thus needs to be consistently replaced. You can accomplish this by regularly consuming foods that contain protein.

### **Repair and Maintenance**

Protein is termed the building block of the body. It is called this because protein is vital in the maintenance of body tissue, including development and repair. Hair, skin, eyes, muscles and organs are all made from protein. This is why children need more protein per pound of body weight than adults; they are growing and developing new protein tissue.

### **Energy**

Protein is a major source of energy. If you consume more protein than you need for body tissue maintenance and other necessary functions, your body will use it for energy. If it is not needed due to sufficient intake of other energy sources such as carbohydrates, the protein will be used to create fat and becomes part of fat cells.

### **Hormones**

Protein is involved in the creation of some hormones. These substances help control body functions that involve the interaction of several organs. Insulin, a small protein, is an example of a hormone that regulates blood sugar. It involves the interaction of organs such as the pancreas and the liver. Secretin, is another example of a protein hormone. This substance assists in the digestive process by stimulating the pancreas and the intestine to create necessary digestive juices.

### **Enzymes**

Enzymes are proteins that increase the rate of chemical reactions in the body. In fact, most of the necessary chemical reactions in the body would not efficiently proceed without enzymes. For example, one type of enzyme functions as an aid in digesting large protein, carbohydrate and fat molecules into smaller molecules, while another assists the creation of DNA.

### **Transportation and Storage of Molecules**

Protein is a major element in transportation of certain molecules. For example, hemoglobin is a protein that transports oxygen throughout the body. Protein is also

sometimes used to store certain molecules. Ferritin is an example of a protein that combines with iron for storage in the liver.

### **Antibodies**

Protein forms antibodies that help prevent infection, illness and disease. These proteins identify and assist in destroying antigens such as bacteria and viruses. They often work in conjunction with the other immune system cells. For example, these antibodies identify and then surround antigens in order to keep them contained until they can be destroyed by white blood cells.

---

## **20.5 Nucleic Acid**

---

Nucleic acids are polymeric macromolecules, or large biological molecules, essential for all known forms of life. Nucleic acids, which include DNA (deoxyribonucleic acid) and RNA (ribonucleic acid), are made from monomers known as nucleotides. Each nucleotide has three components: a 5-carbon sugar, a phosphate group, and a nitrogenous base. If the sugar is deoxyribose, the polymer is DNA. If the sugar is ribose, the polymer is RNA.

Together with proteins, nucleic acids are the most important biological macromolecules; each is found in abundance in all living things, where they function in encoding, transmitting and expressing genetic information—in other words, information is conveyed through the nucleic acid sequence, or the order of nucleotides within a DNA or RNA molecule. Strings of nucleotides strung together in a specific sequence are the mechanism for storing and transmitting hereditary, or genetic, information via protein synthesis.

Nucleic acids were discovered by Friedrich Miescher in 1869. Experimental studies of nucleic acids constitute a major part of modern biological and medical research, and form a foundation for genome and forensic science, as well as the biotechnology and pharmaceutical industries.



## **Types of nucleic acids**

### **Deoxyribonucleic acid**

Deoxyribonucleic acid (DNA) is a nucleic acid containing the genetic instructions used in the development and functioning of all known living organisms (with the exception of RNA viruses). The DNA segments carrying this genetic information are called genes. Likewise, other DNA sequences have structural purposes, or are involved in regulating the use of this genetic information. Along with RNA and proteins, DNA is one of the three major macromolecules that are essential for all known forms of life. DNA consists of two long polymers of simple units called nucleotides, with backbones made of sugars and phosphate groups joined by ester bonds. These two strands run in opposite directions to each other and are, therefore, anti-parallel. Attached to each sugar is one of four types of molecules called nucleobases (informally, bases). It is the sequence of these four nucleobases along the backbone that encodes information. This information is read using the genetic code, which specifies the sequence of the amino acids within proteins. The code is read by copying stretches of DNA into the related nucleic acid RNA in a process called transcription. Within cells DNA is organized into long structures called chromosomes. During cell division these chromosomes are duplicated in the process of DNA replication, providing each cell its own complete set of chromosomes. Eukaryotic organisms (animals, plants, fungi, and protists) store most of their DNA inside the cell nucleus and some of their DNA in organelles, such as mitochondria or chloroplasts.[1] In contrast, prokaryotes (bacteria and archaea) store their DNA only in the cytoplasm. Within the chromosomes, chromatin proteins such as histones compact and organize DNA. These compact structures guide the interactions between DNA and other proteins, helping control which parts of the DNA are transcribed.

### **Ribonucleic acid**

Ribonucleic acid (RNA) functions in converting genetic information from genes into the amino acid sequences of proteins. The three universal types of RNA include transfer RNA (tRNA), messenger RNA (mRNA), and ribosomal RNA (rRNA). Messenger RNA acts to carry genetic sequence information between

DNA and ribosomes, directing protein synthesis. Ribosomal RNA is a major component of the ribosome, and catalyzes peptide bond formation. Transfer RNA serves as the carrier molecule for amino acids to be used in protein synthesis, and is responsible for decoding the mRNA. In addition, many other classes of RNA are now known.

---

## **20.6 Metal binding Biomolecules**

---

Concentration of metal ions in human being's system is controlled within very fine limits. This control is generally exercised by certain biological complexing agents. The deficiency or excess of metal ions causes disorder, which leads to various diseases.

### **Calcium**

Calcium is a critical element in all animals and man. A healthy human adult has about 1.05 kg Ca, of which 99% exists as phosphates resembling the mineral hydroxyapatite,  $\text{Ca}_{10}(\text{PO}_4)_6(\text{OH})_2$ , in bones and teeth. The small remainder is in cellular fluids, existing in partly ionized, or protein bound forms. The primary dietary source of Ca is milk (65-76%), with smaller amounts derived from meat, fish and eggs (5-10%), and still less from non-dairy foods such as nuts, fruits, beans etc. Dietary deficiency of Ca is not a common problem in nations with high dairy product and protein intake, particularly since normal individuals can regulate intestinal absorption and renal conservation mechanism with great precision. Hence, human health problems related to geochemical distribution of Ca, its entry into the human food chain and its bioavailability are relatively uncommon. Exceptions include very poor diets (such as those low in milk and animal proteins or unusual physiologic, other illness, such as intestinal malabsorption). In case of excess of Ca, it comes in to the blood as Ca is rejected by cell and its salts are not soluble. So excess of Calcium leads to the formation of stones, hardening of arteries, and cataracts in the eye.

### **Magnesium**

Magnesium, an abundant element in the earth's crust, is vital to both plant and animal life. Chlorophyll pigment in plants is a Mg-porphyrin complex. All

enzymatic reaction in animals and men that are catalyzed by ATP require Mg as a cofactor. Oxidative phosphorylation, DNA transcription, RNA function, protein synthesis and critical cell membrane functions are all dependent upon optimal Mg concentrations. An average man has about 35g Mg, out of this 99% is either intracellular or in bone, of the 60% in bone, two-third is tightly incorporated into the mineral lattice, but one-third is in an apparently exchangeable bone surface pool. Dietary sources high in Mg include nuts, sea foods, legumes and vegetables, meat is intermediate in Mg content.

### **Potassium**

An adult human has approximately 140 g K of which >90% is both intracellular and exchangeable (K is the predominant cation in intracellular water) since muscle contains most of the body's intracellular water, it also contains most of the K. Since K is found in most animal and vegetable foods, dietary deficiency is exceedingly rare except under unusual conditions (such as diets very high in refined sugars, alcoholic individuals deriving most of their calories from low-K alcoholic beverages in the states of starvation etc.).

### **Sodium**

Sodium is the predominant extracellular cation in animals and man. An adult human has about 105 g Na, about 24% is located in bone and about 65% in extracellular water. Sodium ion equilibrium is maintained primarily by the kidney, the key organ in water and electrolyte balance. Sodium chloride (salt) is the predominant dietary source. Although excessive dietary Cl appear to have no significant ill effect on health, there is much evidence that excessive Na intake results in elevated blood pressure (hypertension) and that reduces Na intake or increased K intake helps to reduce high blood pressure.

### **Cobalt**

Cobalt is an essential element for humans, but its pathway through the food chain to human being remain elusive. Only a little over 1 mg Co is present in an adult human. It is useful to man, insofar as is known, only in the form of vitamin B12B B (cobalamin). Vitamin B12B B is synthesized only by bacteria. Vitamin enters

the human food chain as animal organs or muscle. In man dietary Co deficiency is only likely among strict vegetarians or when the intrinsic factor from the stomach that facilitates BB12 B absorption is absent or severely decreased as in pernicious anaemia.

### **Zinc**

An adult has about 1.5-3.0 g Zn with the largest amounts being in liver and bone. There is evidence that Zn concentrations in blood and several tissues vary considerably in response to many stimuli. Zinc appears to be critical in many functions. Human Zn deficiency in an inherited form in infants is termed acrodermatitis enteropathica and is characterized by behavioral disturbances, diarrhoea, hair loss and severe peri-orificial skin rash, all of which respond with remarkable promptness to Zn administration. Similar syndromes have now been reported many times with penicillamine treatment of other disorders, presumably due to chelation of Zn, as well as during total parenteral nutrition when Zn was not added to the nutritional solutions for even as short a time as two weeks. A more chronic dietary deficiency of Zn (combined with other deficiencies) include dwarfism, hypogonadism and sexual immaturity, the latter reversed with Zn therapy. There is much evidence for marginal dietary deficiencies in humans. The effects include decreased acuity of taste (hypogeusia), impotence, delayed wound healing, hypogonadism and oligospermia, poor development and possible foetal wasting and teratogenesis. Dietary source range in Zn concentrations from 1400  $\mu\text{g}$  gP-1P to 2  $\mu\text{g}$  gP -1P or less in fresh fruit and vegetables. Bioavailability of Zn is especially high from animal tissues and is low from milk and from grains. The latter effect is apparently due to binding to phytic acid and fibre.

### **Molybdenum**

The essentiality of Mo in animals and human beings is assumed from its presence in the metalloenzymes xanthine oxidase and aldehyde oxidase. Mo is also part of the enzyme sulphite oxidase, an inherited deficiency of which cause severe neurologic disorders and early death in humans. However, no naturally occurring Mo deficiency has ever been documented in animals or man, even though several animal deficiencies have been produced experimentally, particularly by using the

Mo antagonist. Molybdenum is present in very small quantities. Molybdenum appears to be readily absorbed from the GI tracts and excreted primarily through the kidneys (though human studies are lacking). In tissues with higher concentration, such as bone, liver and kidney the Mo content can be varied with dietary intake. There is evidence that dietary Mo affects Cu metabolism in animals and man, higher Mo intakes causing mobilization and excretion of Cu. These effects can be elicited in man even with naturally occurring dietary sources of Mo. Since Mo concentrations in grains and vegetables varies enormously (differences up to 500 times) and varies with soil content the possibility of Mo-induced Cu deficiency in man is conceivable, though not reported.

### **Chromium**

The designation of Cr as an element essential to animals and man is quite recent. Insofar as is known, the major biological function of Cr is an integral part of an organic complex originally isolated from yeast termed “glucose tolerance factor” (GTF). This complex apparently includes one Cr (III) ion and two nicotinic acid molecules and may coordinate with three amino-acid molecules, probably glycine, cysteine and glutamic acid. Experimental data indicate that GTF functions in conjunction with insulin, and may in fact aid in binding insulin to sites of action. Other activities apparently include a lowering of serum cholesterol and triglycerides. An adult human has about 6 mg Cr. Trivalent Cr is absorbed in the upper gastrointestinal tract, but only in very small amounts (hexavalent Cr is better absorbed, but only trivalent Cr is biologically active as an essential element). Trivalent Cr as GTF is apparently absorbed much better. Thus conversion to GTF in the gastrointestinal tract may be important, and may vary with age of the individual. Chromium in excess amounts can be quite toxic, dependent upon the chemical species of Cr(III) is much less toxic than the hexavalent form. Chromium is a known carcinogen and toxic metal present abundantly in tannery effluents in India.

### **Copper**

Normal adult human has about 100-110 mg Cu, highest concentrations are found liver, kidney, heart and brain. The prototype functional deficiency of Cu in humans

is an X-linked inherited disorder called Menke's syndrome (Kinky or steely hair syndrome). Cu insufficiency was first suspected by analogy with abnormal wool in Cu-deficient sheep. The defect appears to be decreased gastrointestinal absorption and /or cellular utilization of Cu. The essentiality of Cu is the consequence of its role in metalloenzymes involving several critical biochemical pathways. Several of these enzymes are noted here. Superoxide dismutase, which metabolize the potentially damaging superoxide anion. Lysyl oxidase is a monoamine oxidase required for cross-linking collagen and elastin, the structural macromolecules of connective tissue. Dopamine  $\beta$ -hydroxylase, amine oxidase and tyrosinase are all Cu containing enzymes that interconvert the major neurotransmitters dopamine, noradrenaline and adrenaline, probable accounting for the high concentration of Cu in the brain. The latter enzyme, tyrosinase, is also a key step in pigment production. Cytochrome C oxidase is the key and terminal enzyme of the respiratory chain, accounting for more than 90% of the energy of muscular contraction. Ferroxidase (better known as ceruloplasmin before its role in mobilizing and oxidizing Fe from storage sites was recognized) is believed to account for 95% of serum Cu, and appears to be a multi-functional protein serving as a major transport system for Cu as well. Copper is widely distributed in the food chain, a notable exception being cow's milk. Copper concentration ranges from 20-60  $\mu\text{g gP-1PB}$  Bin animal tissues to less than 2  $\mu\text{g gP-1}$  Pin leafy green vegetables and fruits to less than 0.2  $\mu\text{g gP-1P}$  in cow's milk, which is much less than in human milk. Infants, especially if premature and not breast-fed, are therefore most susceptible to dietary deficiencies; excessive loss of Cu from gastro-intestinal tract due to diarrhoea is the most common precipitating factor.

## **Iron**

The average human adult has about 4-5 g Fe. Of this amount, about 60-70% is present in haemoglobin in red blood cell, 3-5% is in muscle myoglobin, 15% is bound to the Fe storage cellular protein, ferritin, 0.2% occurs as a component of critical respiratory enzymes and 0.004% is bound to the serum transport protein transferrin. Iron deficiency causes anemia because red cells of blood containing less hemoglobin than in normal condition. Acute iron poisoning leads to vomiting,

pallor, shock, circulatory collapse and coma. Chronic conditions are also known in which iron is deposited in tissues and organs of the body. This condition is known as siderosis.

---

## 20.7 Summary

---

The unit deals with the Bioinorganic Chemistry which is the intermediate of inorganic chemistry and biochemistry, it describes the mutual relationship between these two sub-disciplines, with focus upon the function of inorganic “substances“ in living systems, including the transport, speciation and, eventually, mineralisation of inorganic materials, and including the use of inorganics in medicinal therapy and diagnosis. These “substances” can be metal ions (such as  $K^+$ , ferrous and ferric), composite ions (e.g. molybdate), coordination compounds (like cisplatin and carbonyltechnetium), or inorganic molecules such as CO, NO, O<sub>3</sub>. And deals with the macromolecules which is a very large molecule that has a polypeptide chain structure. Proteins, rubber, genes, polysaccharides, and synthetic polymers all consist of macromolecules. Macromolecules interact with each other and with small molecules. All of the interactions reflect the complementary between the interacting species. Sometimes, the complementary is general, as in the association of hydrophobic groups, but more often

an exact fit of size, shape and chemical affinity is involved. Then the unit describe deeply proteins and nucleic acid. And then it describe about metal binding Biomolecules i.e. Calcium, Magnesium, Potassium, Sodium, Cobalt, Zinc, Molybdenum, Chromium, Copper, Iron

---

## 20.8 Review Questions

---

1. What are inorganic biomolecules?
2. Explain the structure of protein.
3. Discuss nucleic acids.
4. Explain iron and calcium containing biomolecules.

5. Explain metal binding biomolecules.

---

## **20.9 References and Suggested Readings**

---

1. Introduction to Bioinorganic Chemistry - Dieter Rehder University of Lund (2008). Lecture notes.
2. Chemistry- Steven S. Zumdahl , Houghton Mifflin Company Boston New York(2009).



---

# Unit - 21 : Choice, uptake and assembly of metal containing units in Biology

---

## Structure of unit

- 21.0 Objectives
- 21.1 Introduction
- 21.2 Bioavailability of Metal Ions
- 21.3 Enrichment Strategies and Intracellular Chemistry of Low-Abundance Metals
- 21.4 Spontaneous Self-Assembly of Metal Clusters
- 21.5 . Specialized Units
- 21.6 Summary
- 21.7 Review Questions
- 21.8 References

---

## 21.0 Objectives

---

At the end of this unit learner can be able to understand

- Importance of biological units
- Role of metal in biological units
- Bioavailabilty of metal ions
- Intracellular chemistry of metals
- Self assembly of metal clusters

---

## 21.1 Introduction

---

It is interesting that, of all the inorganic elements in the periodic table, only a small number are utilized in biological systems. Most frequently encountered are the

alkali- and alkaline-earth ions Na, K, Mg<sup>2+</sup>, and Ca<sup>2+</sup>, required to neutralize the charge of simple inorganic ions such as phosphate and sulfate as well as more complex species such as nucleoside triphosphates, DNA, and RNA. Many first-row transition-metal ions are also of key importance in biology, especially iron, copper, and zinc. The bioinorganic chemistry of vanadium, manganese, cobalt, nickel, and molybdenum, the only naturally occurring second-row transition element, is also being rapidly developed as we become increasingly aware of the important roles of these less-common elements. Tungsten has also been recently added to the list of metals found in biology. How is it that nature chooses to utilize the properties of these specific elements rather than others that, from their known inorganic chemistry, would seem to be of potential value? Why, for example, is there not a respiratory protein with cobalt as the dioxygen carrier, since complexes of this element are well known to bind O<sub>2</sub> reversibly?

As will be seen from the examples discussed in this unit, one factor that seems to dictate the use of metal ions is their relative abundance. It is interesting that, of all the inorganic elements in the periodic table, only a small number are utilized in biological systems. Most frequently encountered are the alkali- and alkaline-earth ions Na<sup>+</sup>, K<sup>+</sup>, Mg<sup>2+</sup>, and Ca<sup>2+</sup>, required to neutralize the charge of simple inorganic ions such as phosphate and sulfate as well as more complex species such as nucleoside triphosphates, DNA, and RNA. Many first-row transition-metal ions are also of key importance in biology, especially iron, copper and zinc. The bioinorganic chemistry of vanadium, manganese, cobalt, nickel and molybdenum, the only naturally occurring second-row transition element is also being rapidly developed as we become increasingly aware of the important roles of these less-common elements. Tungsten has also been recently added to the list of metals found in biology. How is it that nature chooses to utilize the properties of these specific elements rather than others that, from their known inorganic chemistry, would seem to be of potential value? Why, for example, is there not a respiratory protein with cobalt as the dioxygen carrier, since complexes of this element are well known to bind O<sub>2</sub> reversibly?

As will be seen from the examples discussed in this unit, one factor that seems to dictate the use of metal ions is their relative abundance. Iron is the most abundant transition metal in the earth's crust, and it is perhaps not surprising that iron is an important constituent of many bio inorganic systems.

A second factor can be deduced from the fact that the active centers of metalloproteins consist of kinetically labile and thermodynamically stable units. The lability facilitates rapid assembly and disassembly of the metal cores as well as rapid association and dissociation of substrates. Metal ions such as  $\text{Cr}^{3+}$  and  $\text{Co}^{3+}$ , well known in inorganic chemistry for their kinetic inertness, are rarely utilized for similar reasons, the more inert second- and third-row transition elements play almost no role in bioinorganic chemistry despite the fact that they are extremely valuable as homogeneous and heterogeneous catalysts in the chemical industry. In fact, if present in cells, these heavier transition elements can be toxic. As a consequence, some attention has been paid to their mechanism of uptake and transport. When a specific metal ion is required for a given purpose, it can be concentrated by energy-driven processes in a cell. A striking example of this phenomenon is the uptake of vanadium into certain types of sea squirts. With the use of an ATP-requiring reaction. The element is concentrated by more than 5 orders of magnitude from sea water into the blood cells. Termed vanadocytes, of ascidians and tunicates. These cells have ~27 g of V per kg dry weight, more than 100 times the amount of Fe. Some ascidians accumulate other rarely encountered transition metals in biology, including Ti, Cr, and even Nb. The functions of V and these other elements in tunicates are unknown but currently under investigation.

The properties of metal ions in biology are attenuated by their local environment to optimize specific functions. Sometimes, however, the available amino-acid residues are unable to perform this task. One way in which this deficiency has been remedied is by the evolution of cofactors containing specific organic functionalities that modulate the properties of their inorganic guests. These cofactors, such as porphyrins and coeins, are encountered in many different proteins where additional ligands from the peptide chain can further attenuate their properties. Such units thus serve as valuable "bioinorganic chips," much like the

solid-state components in modern electronics equipment, being inserted when their specific functional capabilities are required. Another type of bioinorganic chip is the metal-atom cluster, a unit quite familiar to the inorganic chemist. Iron sulfur clusters such as  $\{\text{Fe}_4\text{S}_4\}^{2+}$  are commonly found in proteins, where they serve important electron-transfer functions. In addition, species such as  $\text{Fe}_3\text{O}_4$ , or magnetite, have been utilized in nature as homing and orientation devices for bacteria, pigeons, bees and probably humans as well. The ability of nature to borrow chemistry from the geosphere for use in the biosphere is fascinating and constitutes a central principle by which we can begin to understand the choice of metal-containing units in biology.

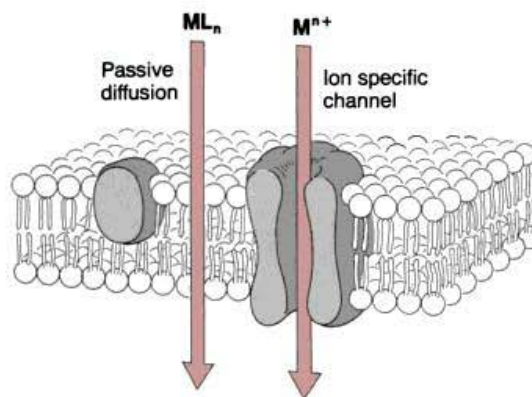

FIGURE : 21.1

---

## 21.2 Bioavailability of Metal Ions

---

Table 21.1 lists the relative abundance of inorganic elements found in the Earth's crust, sea water, Blood plasma, Cell/Tissue indicates that the essential metals in biology are relatively more abundant than the nonessential ones.

Table 21.1: lists the relative abundance of inorganic elements found in the Earth's crust, sea water, Blood plasma, Cell/Tissue.

Element	Crust (ppm)	Sea Water ( $\mu M$ )	Blood Plasma ( $\mu M$ )	Cell/Tissue <sup>a</sup> ( $\mu M$ )
Ca	$4 \times 10^4$	$1 \times 10^4$	$2 \times 10^3$	$1 \times 10^3$
Cd	0.2	$1 \times 10^{-3}$		
Co	25	$2 \times 10^{-5}$	$2.5 \times 10^{-5}$	
Cu	55	$4 \times 10^{-3}$	8–24	~68
Fe	$5 \times 10^4$	$1 \times 10^{-3}$	22	0.001–10
K	$3 \times 10^4$	$1 \times 10^4$	$4 \times 10^3$	$1.5 \times 10^5$
Mg	$2 \times 10^4$	$5 \times 10^4$	500	$9 \times 10^3$
Mn	950	$5 \times 10^{-4}$	0.1	180
Mo	1.5	0.1		$5 \times 10^{-3}$
Na	$3 \times 10^4$	$5 \times 10^5$	$1 \times 10^5$	$1 \times 10^4$
Ni	75	$8 \times 10^{-3}$	0.04	2
V	135	0.03	0.07	0.5–30
W	1.5	$5 \times 10^{-3}$		
Zn	70	0.01	17	180

\* Approximate value based on total content rather than labile concentration

How does nature manage to extract metal ions from their mineral forms and insert them into their bioenvironments? For many ions, such as  $\text{Na}^+$ ,  $\text{Mg}^{2+}$  or  $\text{Zn}^{2+}$ , solubility present no particular problems at the millimolar concentrations required. Some elements such as iron, however, are too insoluble at neutral pH (see Table 2.3) to be readily bioavailable. Apart from solubilization, metal ions must be absorbed by cells, a phenomenon that is incompletely understood. Two possible pathways are illustrated in Figure 21.1. For other ions, there are special chelating ligands that facilitate transport across the cell membrane.

Best understood are the solubilization and mobilization of iron by bacteria, for which has evolved an elaborate system that utilizes many concepts of classic coordination chemistry. We shall therefore discuss this example in some details, since the principles involved are likely to apply to the bioavailability of other metal ions. As already indicated, only very low levels of the free aquated iron are available for uptake by cells. Thus in order to solubilize iron, microorganisms have evolved chelating agents called *siderophores* that bind iron (III) tightly. The siderophores are released by the bacterium into its environment. They sequester iron, solubilizing it in complexed forms that are specially taken up into the cell, where it is subsequently released. One of the best studied siderophores is the

catechol-based compound enterobactin (ent), shown in Figure 3.24. Enterobactin binds Fe (III) very tightly with an overall formation constant  $K_f$ , given in Equation 21.1,

$$K_f = \frac{[\text{Fe}(\text{ent})^{3-}]}{([\text{Fe}^{3+}][\text{ent}^{6-}]}) \quad 21.1$$

of  $10^{49}$ . This value corresponds to an apparent dissociation constant of  $10^{-23}$  at pH 7.0, taking into binding requires the development of mechanisms for release of iron within cells. The trianionic complex of iron produced is soluble and as we shall discuss below, is actively transported into cells.

Information about the structure of the iron-electrobactin complex has been deduced by a series of experiments. The ferric complex of enterobactin has an optical absorption spectrum quite similar to that of tris (catecholato) iron (III) indicating that the ligands coordinate as catecholate dianions rather than via of the amide oxygens and one of the ring oxygens from each aromatic ring. Furthermore, this complex is optically active, which indicates that one of two possible absolute configurations at the iron center predominates. This situation arises because of the formation of A and D isomers, depicted below. Since the trilactone ring of enterobactin has chiral centers, all

In the S conformation the A and D isomers at iron are diastereomers rather than enantiomers. Although it has not yet been possible to obtain suitable crystals of ferric enterobactin for X-ray diffraction studies, the conformation at iron was deduced by comparison to the enterobactin complex of chromium (III). This task was accomplished by studying tris (catecholato) chromium (III) revealed that the spectrum of the latter isomer resembles that of the enterobactin complex. Given the very similar structures of the iron (III) and chromium (III) tris (catecholato) complexes, as well as the identical chromatographic properties of Cr (III) and Fe (III) enterobactin, it was concluded that the latter has predominately D conformation. This conclusion has recently been supported by the crystal structure analysis of the vanadium (IV) analogue,  $[\text{V}(\text{enterobactin})]^{2-}$ . The structure is depicted in Figure 21.2

Ferric enterobactin interacts with specific receptors on the E.coli outer and inner membranes and is transported into cells via an energy-dependent mechanism as shown in Figure 21.3. Its uptake has been followed by using.

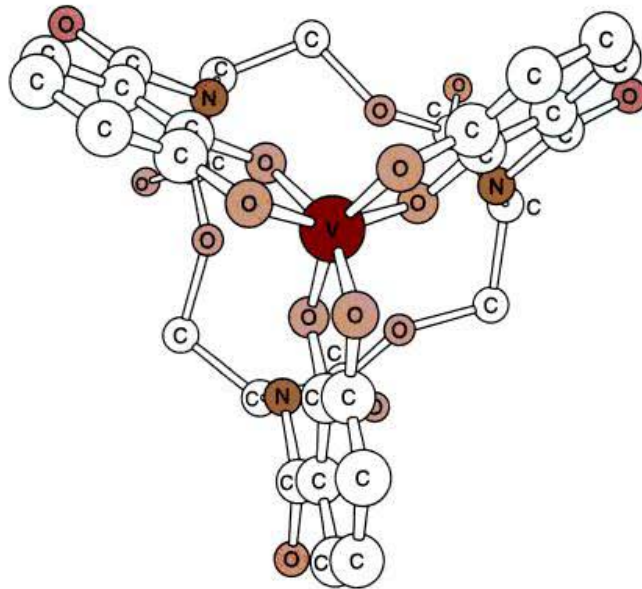

Figure 21.3 Structure of vanadium (IV) enterobactin determined by X-ray crystallography.

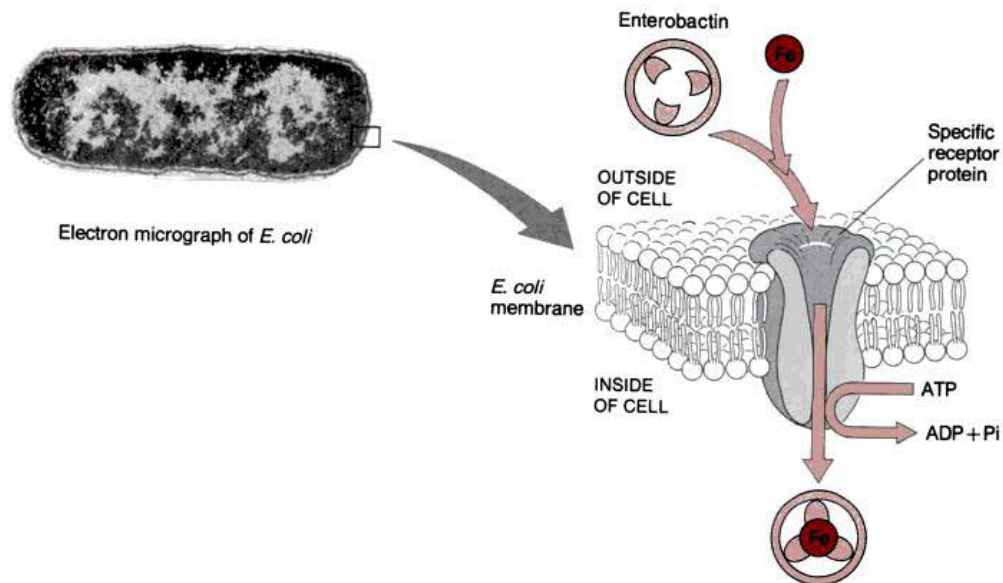

Figure 21.4 Scheme showing the ATP driven uptake of ferric enterobactin into *E. coli* cells through a specific receptor protein in the cell membrane.

Radioisotopes of iron. Studies of the kinetics of  $[\text{Fe}(\text{ent})]^{3-}$  uptake revealed saturation behavior analogous to that observed for most enzymes and interpretable in terms of a Michaelis-Menten type model. For  $[\text{Fe}(\text{ent})]^{3-}$ , the apparent binding constant ( $K_m$ ) is approximately 0.3 micromolar, indicative of reasonably tight binding to a specific receptor. The availability of such uptake assays has allowed investigations of the features of the  $[\text{Fe}(\text{ent})]^{3-}$  structure that are recognized by the receptor and has facilitated tests of the mechanism of iron release. For example simple catecholate complexes such as  $[\text{Rh}(\text{cat})_3]^{3-}$  do not inhibit  $[\text{Fe}(\text{ent})]^{3-}$  uptake. Rhodium was used in these studies, since it forms kinetically inert complexes. Modification of the ligand to incorporate the amide linkages of enterobactin, however, yielded complexes that are quite potent inhibitors. Thus,  $[\text{Rh}(\text{N,N-dimethyl-2,3-dihydroxybenzamide})_3]$  effectively blocks  $[\text{Fe}(\text{ent})]^{3-}$  uptake at 100 micromolal levels. These observations suggest that whereas the tris (catecholato) and amide portions of the metal-enterobactin complex are required for recognition by the membrane receptor trilactone ring is not essential. This result indicates that synthetic analogs of enterobactin retaining the dihydroxybenzamide groups but not the remainder of the structure should compete for the receptor. Such compounds



had been previously prepared as stable analogs of enterovactin lacking the hydrolytically sensitive trilactone functionality. One such compound is MECAM, shown in Figure 21.5, in which the trilactone is replaced by a 1,3,5-trimethylenebenzene grouping. The ligand binds iron (III) nearly as tightly as enterobactin itself ( $K_f=10^{46}$ ). Subsequent work revealed that the rhodium complex of MECAM is in fact a good inhibitor of  $[\text{Fe}(\text{ent})]^{3-}$  uptake. Furthermore, the iron complex of this ligand is absorbed by cells and can function as a source of iron. These structure activity relations have thus told us a lot about the nature of the receptor  $[\text{Fe}(\text{ent})]^{3-}$  interaction, even though the receptor itself has yet to be characterized.

Finally, we come to the question of the mechanism of iron release. The binding of iron (III) to enterobactin is so tight that unaided release would be too slow to be biologically relevant. Several mechanisms appear possible. First the sensitive nature of the enterobactin structure suggests that ligand hydrolysis could be utilized for iron release. The effectiveness of Fe (III)-MECAM, which lacks any easily hydrolyzable groups, as an iron source indicates that this mechanism cannot be the only one. A second possibility is that iron is reduced from Fe(III) to Fe (II), affording a more-labile and less-stable form of the complex that would release the metal in the cytoplasm. The reduction potentials for the tris (catecholato) iron (III) complexes at physiological pH are estimated to be approximately  $-750$  mV versus NHE. This chemical structure value would appear to preclude reduction at neutral pH. Nonetheless, since six protons are released upon metal binding to enterobactin and since ferric enterobactin itself can be protonated with a  $\text{pK}_a$  slightly intracellular iron-binding ligand that. Possibly in conjunction with redox chemistry, strips the metal from enterobactin in cells. Further studies are necessary to discover what mechanisms of iron release are actually used in vivo.

---

### **21.3 Enrichment Strategies and Intracellular Chemistry of Low-Abundance Metals**

---

There are several mechanisms by which a cell can take up and concentrate a specific metal ion from its environment. In the dramatic case of vanadium

mentioned earlier in this unit, ascidians and tunicates must accumulate the element from sea water, where it exists almost exclusively in the form of  $\text{VO}_4^{3-}$  ion. This negatively charged species enters the cell by means of a specific system known to transport anions, such as sulfate ion, through the outer membrane. Once inside the cell vanadium is reduced, binds to intracellular components, and so can no longer diffuse out into the medium. Other elements also gain access to the cytoplasm by means of the same aniontransport system. An interesting example is chromium, which in the form of the chromate anion cancer are unknown, its mechanism of entering cells and

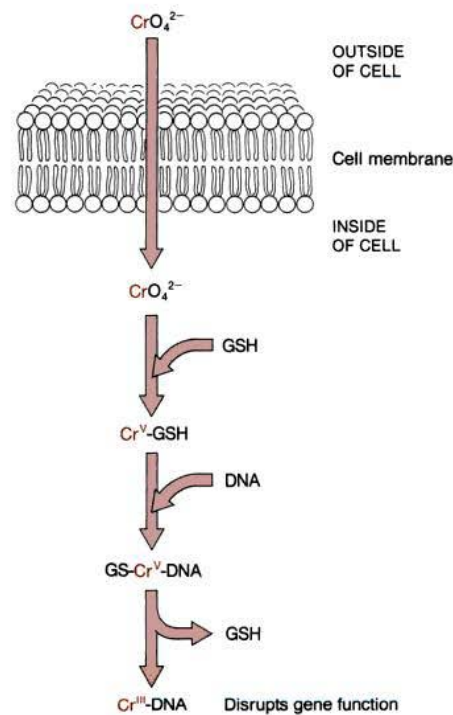

Figure 21.4

Model for cellular uptake and genotoxic action of chromate ion. The  $\text{CrO}_4^{2-}$  ion enters the cell through specific channels, is reduced by glutathione (GSH), and binds covalently of DNA.

Becoming immobilized has recently been worked out, as indicated in Figure 21.4 Like vanadate ion, chromate is carried into cells by the anion-transport system. In

the cytoplasm, it reacts with glutathione (GSH), an intracellular tripeptide present in ~ 5mM concentration that

For, neutral metal complexes, cellular uptake can occur by passive diffusion across the cell membrane. Cisplatin is administered by intravenous injection as an aqueous saline solution. Approximately half the platinum binds to serum proteins and is excreted. The rest is distributed among various tissues. In serum, the drug remains largely as cis-[Pt(NH<sub>3</sub>)<sub>2</sub>Cl<sub>2</sub>], owing to the relatively high chloride-ion concentration, ~0.1M. As a neutral molecule, cisplatin diffuses passively across cell membranes into the cytoplasm, where it encounters a substantially lower chloride-ion concentration (~3 mM). Hydrolysis produces cationic complexes such as cis-[Pt (NH<sub>3</sub>)<sub>2</sub> (OH<sub>2</sub>)Cl]<sup>+</sup> that diffuse to DNA, itself a polyanion, where they bind to form cytotoxic lesions. The hydrolysis reactions of cis -DDP are an important aspect of its biological activity. The chloride ions are displaced in a stepwise manner to form aqua and hydroxospecies. These hydrolyzed forms of the drug react more rapidly with DNA than cis-DDP does. Studies of the rate of formation of cis-DDP complexes with calf-thymus DNA revealed the kinetics of DNA binding to be identical to those of hydrolysis of the first chloride ion from the platinum coordination sphere. Furthermore <sup>195</sup>Pt (I=1/2) NMR studies of the binding of cis-and trans DDP to ~ 40 base pair fragments of DNA from chicken erythrocytes revealed that platinum reacts first to form monofunctional adducts in which only one bond is made to the nucleic acid. They then slowly close to bifunctional adducts, where there are two platinum-nucleobase bonds. Both chemical processes occur with half lives of two or three hours, the rate-determining steps being loss of the chloride ion. What is important here is that, by changing its chemical form, in particular by transforming from a neutral molecule to a cation, the drug becomes trapped within cells, where it is able to damage their genomes and exhibit antitumor activity. This aspect of its mechanism is essentially the same as utilized by the other low-abundance metals, V and Cr, discussed previously.

Although binding to DNA is generally accepted to be an integral part of the antitumor mechanism of cisplatin, cis-DDP hydrolysis products also interact with other intracellular components. As with chromium, one such reaction is that with

glutathione, Which, as expected from hard-soft acid-base theory , binds readily to cisplatin and its hydrolysis product. This chemistry probably ameliorates the toxic side effects of the drug without affecting its anticancer activity, which correlates best with the formation and persistence of cis- $\{Pt(NH_3)_2\}^{2+}$  / DNA adducts. Another intracellular component postulated to react with platinum anticancer drugs is ascorbic acid, which is known to reduce Pt(IV) to Pt (II). This chemistry could be important in the activation of a new class of orally ingested Pt(IV) anticancer compounds that have recently entered clinical trials. Such reactions are therefore important subjects for investigation by the bioinorganic chemist.

---

## 21.4 Spontaneous Self-Assembly of Metal Clusters

---

Many, If not most, metals coordinate to their binding sites in proteins and nucleic acids as simple ions. Thus,  $Zn^{2+}$  binds to carboxypeptidase and to zinc-finger domains, copper binds plastocyanin as either  $Cu^+$  or  $Cu^{2+}$ , and so forth. Sometimes, however, a more complex metal-containing unit is required. Two such examples are described here to show how nature can use inorganic cluster chemistry to achieve specific function in metalloproteins. Although the detailed mechanisms by which these clusters are assembled and inserted into proteins in vivo are unknown, it is likely that the process involves spontaneous self-assembly.

Although ultimate proof of the existence of the  $nFe-nS$  clusters came from protein X-ray crystal-structure determinations, values for the high-resolution metrical parameters of the clusters and , especially, their overall charge have often relied heavily on the synthesis and characterization of replicative model complexes. Moreover the application of electronic absorption, EPR and Mossbauer spectroscopy to proteins of unknown composition and structure, once the major cluster classes had been defined, enabled the various cores to be identified rapidly and reliably without recourse to protein X-ray crystal-structure determinations, which often take years to complete. Finally, several of the structures were unprecedented, not only in biology but in inorganic chemistry as well , further contributing to the enthusiasm with which each new result was met and raising important challenges for the synthetic model chemist. Here we describe the basic

structure types, charges on the protein clusters and physical properties. The synthetic model work is treated separately in the following section.

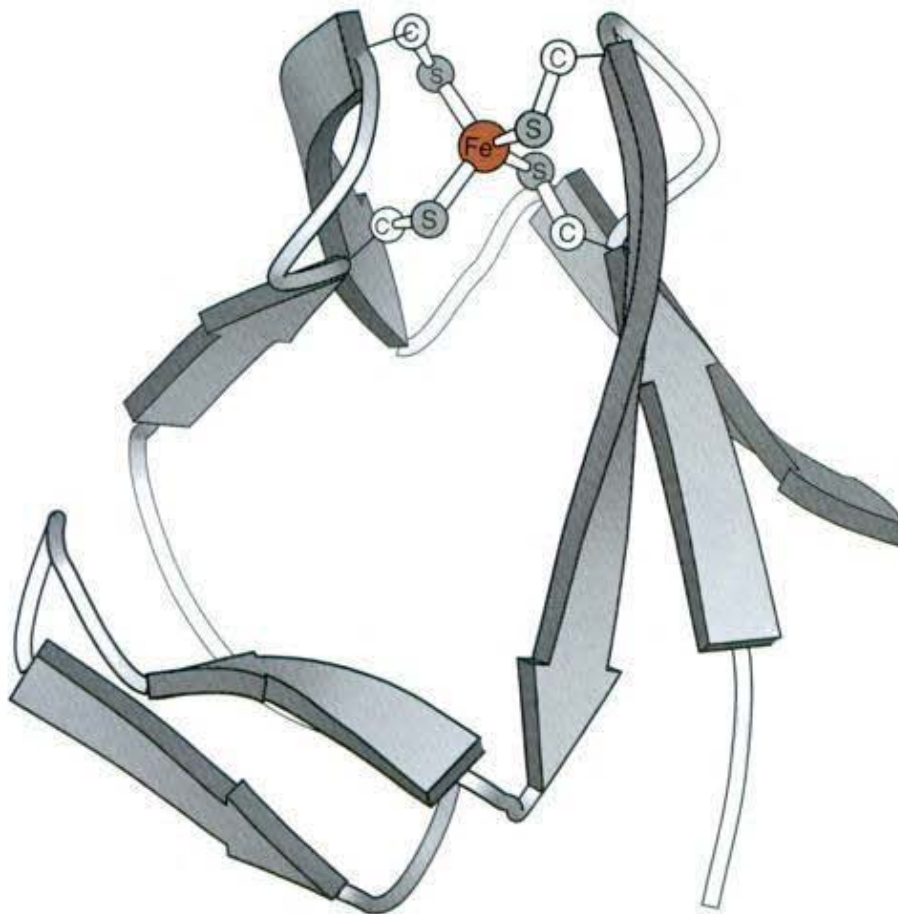

**Figure 21.5**

**Structure of rubredoxin from *C. pasteurianum* depicting its iron core geometry.**

(i) [1Fe-0S]. Figure 21.5 shown the result of a crystal analysis of the protein *C. pasteurianum* rubredoxin (Rb). This protein contains a single iron atom tetrahedrally coordinated by four cysteinato sulfur atoms with an average Fe-S bond distance of 2.29 (2) Å. The cysteine legands contributed from the protein chain occur in pairs, -Cys(6) -X-X -Cys (9) - Gly and Cys (39) -X-X- Xys(42)- Gly, where -X- represents an intervening amino acid. Although crystallography

cannot reveal the overall charge on the  $\{\text{Fe}(\text{SR})_4\}^{n-}$  unit in the protein, the iron was shown clearly to be high-spin ferric by EPR and Mössbauer spectroscopy. The red color of the oxidized form of Rb derives from a S-Fe charge transfer band at 490 nm. The measured redox potentials of several redbreoxins fall in the  $-50$  to  $+50$  mV range at pH7.

(ii) [2Fe-2S]. The X-ray structure of a [2Fe-2S] ferredoxin (Fd) from *S. platensis* revealed the occurrence of an  $\{\text{Fe}_2\text{S}_2(\text{S-cys})_4\}^{2-}$  cluster in which two

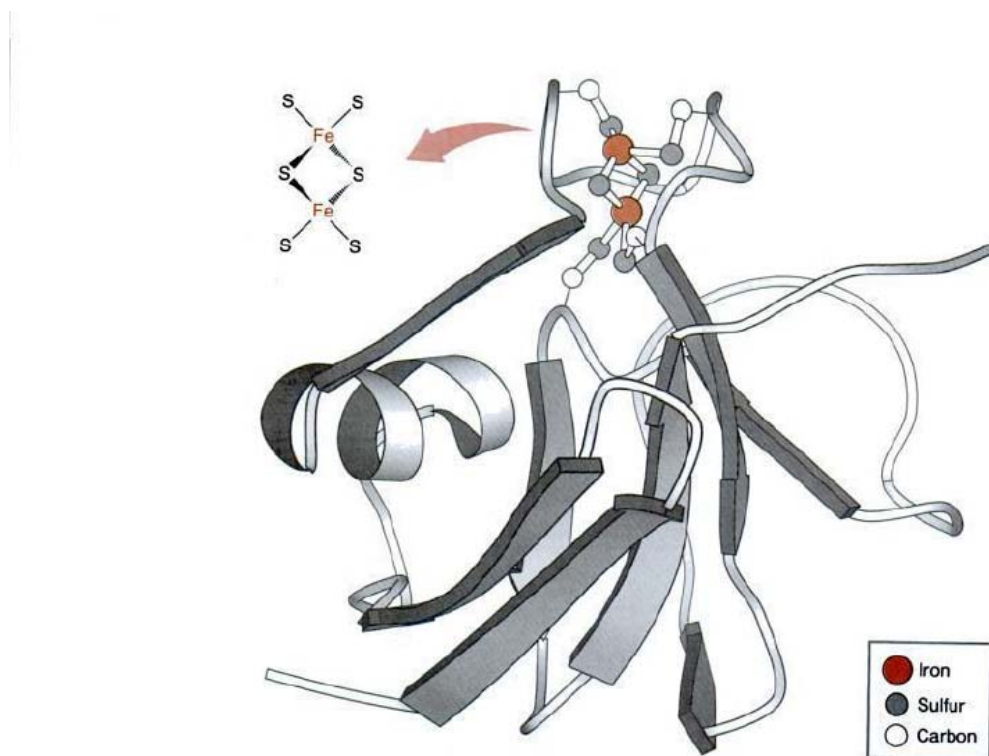
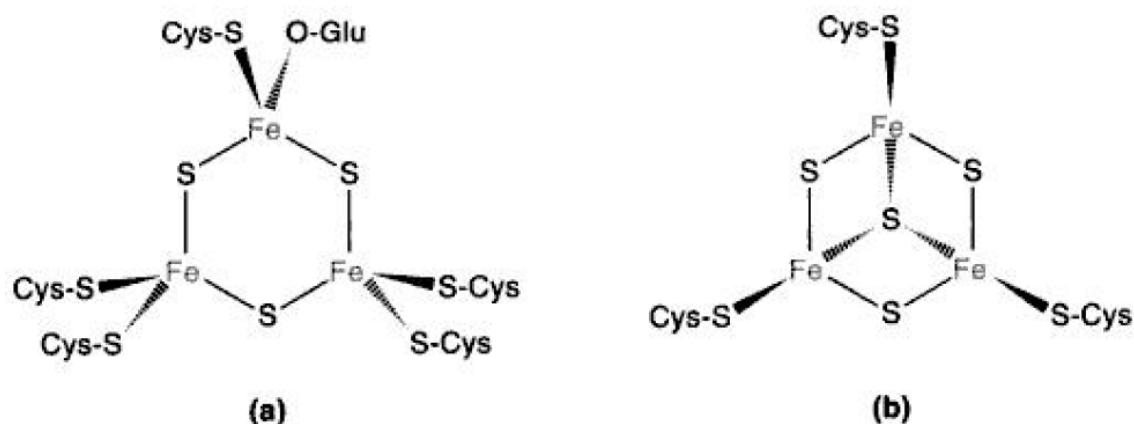

**Figure 21.6 Structure of *S. platensis* ferredoxin and its 2Fe-2S cluster.**

Sulfide ligands bridge the two tetrahedrally coordinate iron atoms (Figure 21.6). The doubly bridged  $\text{Fe}_2\text{S}_2$  unit has an Fe...Fe distance of 2.7 Å. Since the oxidation states readily available to iron in a tetrahedral sulfur environment are +2 and +3, the charge on the  $\{\text{Fe}_2\text{S}_2\}^{n+}$  core can, in principle, vary from 0 (Fe II Fe II) to +1 (Fe II Fe III, mixed-valence form) to +2 (Fe III Fe III). These latter two forms exist in the proteins and are readily distinguishable by their physical properties. In fact, the iron-sulfur core structure of the [2Fe-2S] protein class was

correctly deduced from these physicochemical data before it was confirmed by protein crystallography.

Since the iron centers are four-coordinate, the crystal-field splitting is weak, and the metals are high-spin in both oxidized and reduced forms. The presence of the bridging sulfur atoms provides a pathway for antiferromagnetic exchange coupling, however, such that the ground state of the oxidized, diiron (III) form of the proteins is diamagnetic ( $S_r=0$ ). The paramagnetic  $Fe^{II}Fe^{III}$  form of the  $[2Fe-2S]$  ferredoxins was a subject of much interest when they were first discovered. Superhyperfine coupling to both iron nuclei ( $^{57}Fe$ ) and the bridging sulfide ( $^{33}S$ ; also  $^{77}Se$  in a selenide-



**Figure 21.7**

Scheme showing the original planar (left) and corrected non-planar (right)  $(Fe_3S_4)$  cluster in *A. vinelandii* ferredoxin. magnetic, mixed-valence  $Fe^{II}Fe^{III}$  form of the  $[2Fe-2S]$  ferredoxins was a subject of much interest when they were first discovered. Superhyperfine coupling to both iron nuclei ( $^{57}Fe$ ) and the bridging sulfide ( $^{33}S$ ; also  $^{77}Se$  in a selenide-substituted Fd) established electron delocalization over the cluster.

(jjj)  $[3Fe-4S]$ . Originally the X-ray crystal structure of the 7-iron ferredoxin from *A. vinelandii* was interpreted as having a  $[4Fe-4S]$  and a  $[3Fe-3S]$  cluster. The latter was reported to have a nearly planar, six-membered  $Fe_3S_3$  ring (Figure 21.7) and, as such, was unique not only among iron-sulfur proteins but among small-

molecule iron-sulfur complexes as well. As was recently shown by two groups, including the original investigators, the structure originally reported was grossly in error, owing to the wrong choice of a space group from between the enantiomeric pairs  $P4_12_12$  and  $P4_32_12$ . The correct structure has chain folding closely analogous to that of the 8Fe-8S

ferredoxins, discussed below, a feature that was completely missed in the original analysis. An additional important change is reassignment of the tri-iron cluster as  $[Fe_3S_4]$  having the geometry shown in Figure 21.10. This non-planar structure can be derived from the (4Fe- 4S) core (see next section) by removing an Fe-S (cysteine) unit from one of the eight corners of the cube,

a formal transformation illustrated in Equation 21.2. EXAFS data on the *A. vinelandii* Fd, a 3Fe-4S Fd from *Desulfovibrio gigas*, and an inactive form

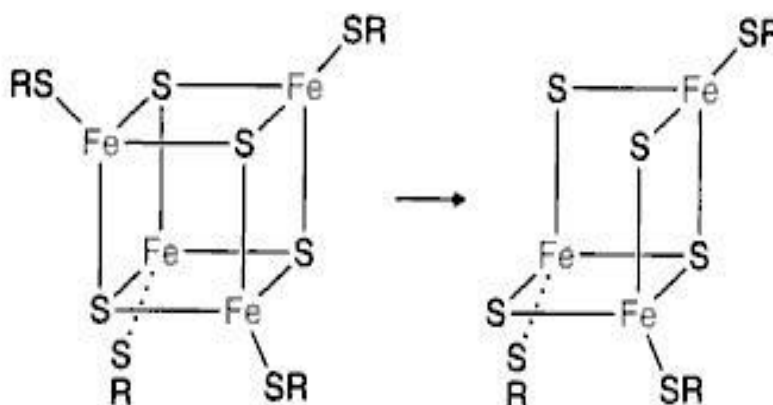

Figure (21.2)

of aconitase all support the occurrence of the same  $[3Fe-4S]$  cluster. In *A. vinelandii* Fd, three cysteine thiolate groups anchor the cluster to the protein chain, as expected from Equation 21.2.

The sequence of historical events leading to the correct identity of the  $[3Fe-4S]$  cluster in *A. vinelandii* is of pedagogical interest. Mossbauer and EXAFS spectral studies on *D. gigas* Fd as well as a 3Fe form of aconitase revealed two distinct iron sites, in a 2:1 ratio and  $Fe \cdots Fe$  distances of  $2.7 \text{ \AA}$ . Both pieces of data disagreed with the original structure report for *A. vinelandii* Fd, which showed three



equivalent iron sites and Fe-Fe distances of  $4.1 \text{ \AA}$ . Moreover, addition of ferrous iron and no inorganic sulfide to beef-heart aconitase led to active enzyme. This result and a careful measurement of the inorganic sulfide content of the protein gave a [3Fe-4S] stoichiometry, in contrast to the [3Fe-3S] result from the earlier crystal structure. Thus either nature had two very different kinds of 3Fe clusters, or one of the structural determinations was in error, as proved to be the case. One lesson for student of bioinorganic chemistry is that protein crystal structures should not be considered as credible as small-molecule X-ray structures. Even when errors in space-group assignment, as happened here, are not made, interpretation of electron-density maps from protein-crystallographic data is at least partly subjective.

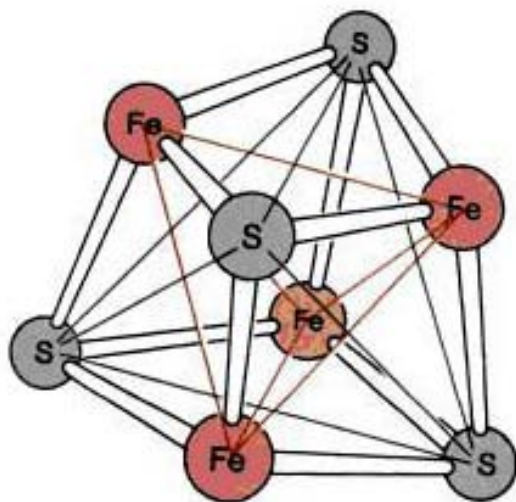

**Figur 21.8**

(iv) [4Fe-4S]. The most ubiquitous iron-sulfur clusters in biology fall into this class. The basic structure is a distorted cube with alternating Fe and S atoms at the corners. The result is two interpenetrating concentric tetrahedra of four iron and four sulfide atoms, with mean Fe-Fe and S-S distances of  $2.5 \text{ \AA}$  and  $3.55 \text{ \AA}$  respectively (Figure 21.8). The cube is anchored to the protein by four cysteinyl sulfur atoms at the four Fe corners, resulting in a distorted tetrahedral coordination geometry. Protein X-ray structural results for these [4Fe-4S] clusters are available for both oxidized

and reduced forms: of HiPIP from *Chromatium. A. oinelandi* ferredoxin 1, the 7Fe/8S protein discussed previously, and *P. aerophilus* ferredoxin, an 8Fe/8S protein that contains two distinct  $\{Fe_4S_4\}^{2+}$  clusters. The relationship between the position in the sequence of the eight cysteine residues that bind the two [4Fe-4S] centers in *P. aerophilus* Fd and their coordination to the clusters is interesting. The sequence runs -X-Cys(8)-X-X-Cys(11)-X-X-Cys(14)-X-X-X-Cys(18)-X-X-Cys(35)-X-X-Cys(38)-X-X-Cys(41)-X-X-X-Cys(45)-...

Despite the fact that the eight cysteines fall in two clusters of four each, only three of the four bind to an individual [4Fe-4S] unit, corresponding to Cys-X-X-Cys but not to Cys-X-X-X-Cys. This preference has been explained as a means of providing NH...S hydrogen bonding from an amide hydrogen of the peptide backbone to the iron sulfur cluster, formally to the +2 oxidation level required for the  $\{4Fe-4S\}^{2+}$  unit. In subsequent work it was found that elemental sulfur could be substituted for sulfide in the presence of enough thiolate to serve as a reducing agent (Equation 21.6, Synthetic route to the [1Fe-2S] analog family were discovered

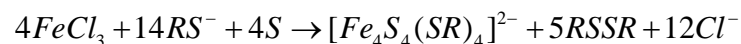

shortly after the preparation of the first tetranuclear cluster, and the preparation and characterization of mononuclear rubredoxin models subsequently followed. Figure 21.14 pictorially summarizes the assembly of these complexes together with some of the identified intermediates.

(iv) Cluster chemistry and core extrusion. From studies of chemical reactions of iron-sulfur model complexes were derived further strategies to probe the properties of analogous clusters in the proteins. One reaction that proved to be of practical significance is ligand substitution, in which the terminal thiolates are replaced in a stepwise fashion (Equations 21.3 and 21.4).

Arylthiols, for example, PhSH, are more effective than alkylthiols in promoting these reactions, owing to the weaker acidity of the latter. From

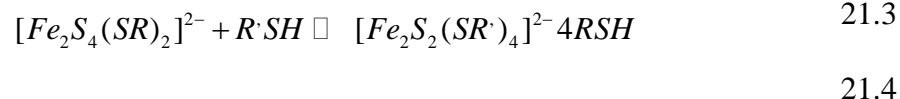
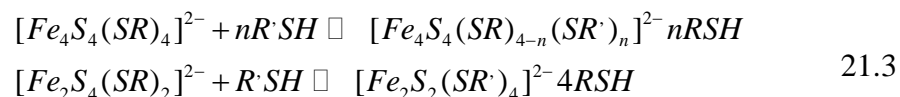

knowledge of this chemistry evolved parallel reactions with the proteins in which [n Fe-nS], n = 2 or 4, clusters could be removed intact from the polypeptide chain. These reactions, which have been termed core extrusions, have proved to be valuable for identifying iron-sulfur cluster types in proteins of previously uncharacterized cores. They are usually carried out in an unfolding solvent such as 80 percent v/v DMSO/H<sub>2</sub>O, that denatures the protein enough to permit the substitution reaction to take place (Equation 21.5). Core extrusion reactions have been applied successfully to identify, inter alia,

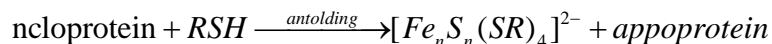

[4Fe- 4S] clusters in C. pasieurianum hydrogenase, the Fe protein of its nitrogenase, and [2Fe-2S] clusters in Fd II from A. vinelmIdii and milk xanthineoxidase, Although two-Fe and four-Fe clusters are known to interconvert in the presence of some thiols, sufficient care and control experiments usually enable one to avoid these potentially misleading reactions. A notable exception

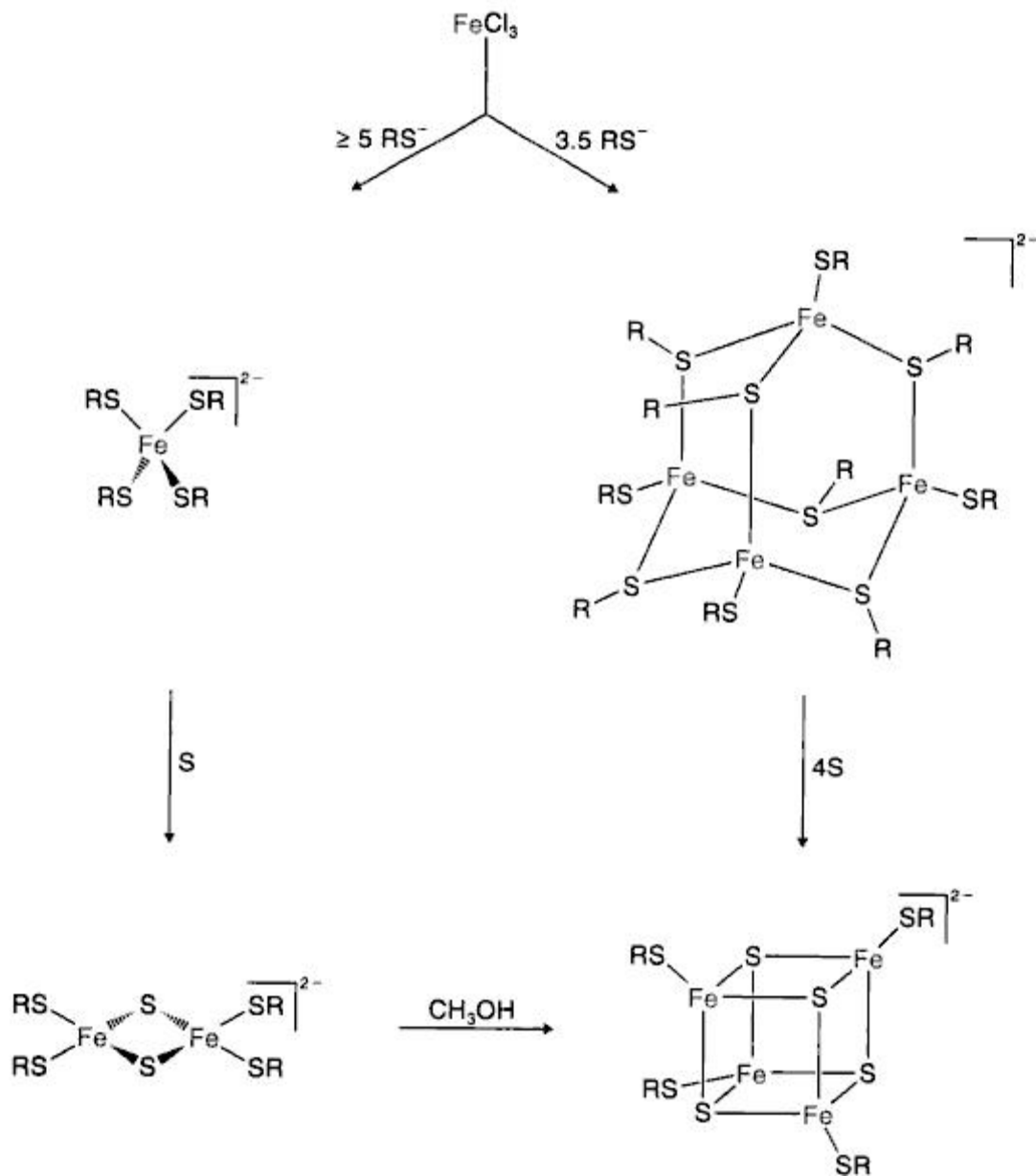

Figure 21.9 Routes to synthetic models of iron-sulfur clusters from proteins.

however, was the extrusion of (2Fe-2S) clusters from the [3Fe-4S] proteins. The clusters extruded by the chemistry shown in Equation 21.5 can be identified by their characteristic absorption spectra and even by  $^{19}F$  NMR spectra copy when

fluorinated thiols ( $\text{HSR}_F$ ) such as p-trifluoromethylbenzenethiol are employed. The latter method works well because of the different paramagnetic contact shifts for  $(\text{Fe}_2\text{S}_2(\text{SR}_F)_2)^{2-}$  and  $(\text{Fe}_4\text{S}_4(\text{SR}_F)_4)^{2-}$  clusters.

---

## 21.5 . Specialized Units

---

Apart from the simple metal aqua ions and polymetallic clusters discussed thus far, there are some other specialized metal-binding molecules in biology that deserve mention. These units differ from ionophores such as enterobactin, which has a single functional purpose. Like the iron-sulfur clusters, they can be inserted into several different metalloproteins and their properties attenuated to meet a particular metabolic need.

**Porphyrins.** Porphyrins are tetrapyrrole macrocycles that bind iron, magnesium, and other metal ions, forming a square-planar arrangement of four nitrogen atoms. Various substituents on the periphery of the porphyrin ring attenuate its electronic properties, further contributing to the utility of this important class of metal-binding ligand. Metalloporphyrins can be anchored to proteins either directly, through covalent bonds to the substituents on the pyrrole rings, or through ligand binding to the two available axial coordination positions above and below the ring of the macrocycle. Both kinds of bonds occur in porphyrin-containing proteins.

The enzyme probably ruffles the porphyrin in order to direct one of the pyrrole nitrogen lone pairs out of the plane of the ring for iron binding. In support of this notion is the fact that metal ions are chelated by N-alkyl porphyrins about 10<sup>4</sup> times more rapidly than by nonalkylated analogs.

Alkylation is also known to distort the porphyrin ring in a manner that facilitates metal binding. This observation has been used to great advantage in the design of antibodies to N-alkyl porphyrins that catalyze insertion of metals into porphyrins.

**Corrins and Hydrophyrins.** Another specialized unit is the corrins, the structure of which may be found in Figure 1.3. Like porphyrins, corrins are comprised of four pyrrole rings in the form of a macrocycle and utilize the four

nitrogen atoms to coordinate a metal in an approximately square-planar fashion. The major difference, however, is the absence of a methine carbon atom linking the A and O pyrrole rings, a feature that distorts the geometry at the metal center and has been held responsible for some of the interesting properties of the resulting complex. Cobalt forms the major metal-corrinoid complex of interest in bioinorganic chemistry, the resulting vitamin-B<sub>12</sub> molecule and its coenzyme forms being important functional units for effecting 1,2-isomerization and radical-promoted redox reactions.

Binding to the enzyme activates the coenzyme in ways not yet fully delineated. Corrins are also found in nature as their nickel complexes, which are used by hydrogenases of thermophilic organisms that evolve methane.

Another class of specialized ligands related to the porphyrins are the hydrophyrins, including siroheme, chlorins, bacteriochlorins, isobacteriochlorins, corphins, and dioneheme. Corphin, for example, is a hydrophyrin that is reduced from the porphyrin level by ten electrons. This tetrapyrrole occurs naturally as factor F<sub>430</sub>, a nickel-containing prosthetic group of *S*-methyl coenzyme-M reductase found in methanogenic bacteria.

**Metal-Nucleotide Complexes.** One of the most important and ubiquitous molecules in cells is adenosine triphosphate, or ATP. In particular, the Mg<sup>2+</sup> complex of this polyanion is frequently required as a substrate for phosphoryl and nucleotidyl transferase enzymes. The Mg<sup>2+</sup>, Ca<sup>2+</sup>, Na<sup>+</sup>, and K complexes of ATP are important substrates for ATPases, enzymes that catalyze the hydrolysis of ATP and use the energy derived from this reaction for energy transduction. Metal ions can bind to the  $\alpha$ ,  $\beta$ , and  $\gamma$ -phosphate ester oxygen atoms as well as to the nitrogen heteroatoms of the base. For the Mg<sup>2+</sup> ion, coordination occurs exclusively at the oxygen atoms, with water occupying the remaining octahedral positions about the metal.

**Molybdenum-Binding Cofactors.** As already mentioned, Mo is the only essential second-row transition metal in biology. Its special value, as will be shown, is its ability to undergo two-electron transfer reactions, especially between the Mo(VI) and Mo(IV) oxidation levels. In addition, it is able to transfer an oxo atom to

substrates), as illustrated in Equation 21.10. There are at least two specific cofactors that contain molybdenum. One of these is

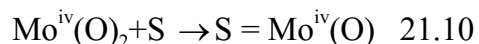

the so-called iron-molybdenum cofactor, or FeMoco, that occurs in the enzyme nitrogenase. Recently the structure of the molybdenum-iron protein of nitrogenase has been crystallographically determined at 2.2 Å resolution and a model for FeMoco has been proposed. The cofactor consists of two cuboidal fragments, one containing four iron atoms, and the other three iron atoms and the molybdenum atom. The Mo is octahedrally coordinated, whereas iron atoms at the interface of the two cube fragments appear to have open coordination sites. This feature has led to the speculation that dinitrogen binds and is activated for reduction by two or more iron atoms at the center of the cluster and may not coordinate directly to molybdenum. Such a hypothesis is appealing, since alternative nitrogenases have been discovered that do not contain molybdenum, but have other metals, specifically vanadium or iron, instead. Much more work is required to test such an idea. The other molybdenum cofactor is present in reductases, oxidases, and dehydrogenases and functions in oxo transfer chemistry. The molybdenum-binding moiety is a substituted pterin that coordinates the metal via two sulfur atoms. This modified pterin was identified after the discovery that a compound called urothione, a molecule of known structure, is a major urinary metabolite of the molybdenum cofactor. Although all the known enzymes that require a molybdenum cofactor, except nitrogenase, contain this pterin derivative, the other metal-coordinating atoms differ significantly. This enzyme-specific property is similar to that previously encountered for the better-understood metalloporphyrins.

The role of the reduced pterin in the function of the molybdenum oxo transferases remains to be determined. The organic moiety can undergo redox reactions that could be integral components of the electron-transfer pathways in the enzymes. Alternatively, the pterin could serve merely to store and transfer molybdenum from protein to protein. The aqueous chemistry of molybdenum is dominated by oxo anions such as molybdate,  $\text{MoO}_4^{2-}$ , and by polymolybdates such as  $\text{Mo}_7\text{O}_{74}^{6-}$ . Chelatable cationic species are unavailable at pH 7. This aspect of molybdenum

aqueous chemistry may have required the development of special ligands for handling this metal and for incorporating it into the active sites of enzymes.

---

## 21.6 Summary

---

As have be seen from the examples discussed in this unit, one factor that seems to dictate the use of metal ions is their relative abundance. Iron is It is interesting that, of all the inorganic elements in the periodic table, only a small number are utilized in biological systems, Mot frequently encountered are the alkali- and alkaline-earth ions  $\text{Na}^+$ ,  $\text{K}^+$ ,  $\text{Mg}^{2+}$ , and  $\text{Ca}^{2+}$ , required to neutralize the charge of simple inorganic ions such as phosphate and sulfate as well as more complex species such as nucleoside triphosphates, DNA, and RNA. Many first-row transition-metal ions are also of key importance in biology, especially iron, copper and zinc. The bioinorganic chemistry of vanadium, manganese, cobalt, nickel and molybdenum, the only naturally occurring send-row transition element is also being rapidly developed as we become increasingly aware of the important roles of these less-common elements. Tungsten has also been recently added to the list of metals found in biology. How is it that nature chooses to utilise the properties of these specific elements rather that others that, from their known inorganic chemistry, would seem to be of potential value? Why, for example, is there not a respiratory protein with cobalt as the dioxygen carrier, since complexes of this element are well known to bind  $\text{O}_2$  reversibly?

As have be seen from the examples discussed in this unit, one factor that seems to dicatate the use of metal ions is their relative abundance. Iron is the most abundant transition metal in the earth's crust, and it is perhaps not surprising that iron is an important constituent of many bio inorganic systems.

A second factor can be deduced from the fact that the active centers of metalloproteins consist of kinetically labile and thermodynamically stable units. The liability facilitates rapid assembly and disassembly of the metal cores as well as rapid association and dissociation of substrates. Metal ions such as  $\text{Cr}^{3+}$  and  $\text{Co}^{3+}$ , well known in inorganic chemistry for their kinetic inertness, are rarely utilized for similar reasons, the more inert second- and third-row transition



elements play almost no role in bioinorganic chemistry despite the fact that they are extremely valuable as homogeneous and heterogeneous catalysts in the chemical industry. In fact, if present in cells, these heavier transition elements can be toxic. As a consequence, some attention has been paid to their mechanism of uptake and transport. When a specific metal ion is required for a given purpose, it can be concentrated by energy-driven processes in a cell. A striking example of this phenomenon is the uptake of vanadium into certain types of sea squirts. With the use of an ATP-requiring reaction. The element is concentrated by more than 5 orders of magnitude from sea water into the blood cells. Termed vanadocytes, of ascidians and tunicates. These cells have ~27 g of V per kg dry weight, more than 100 times the amount of Fe. Some ascidians accumulate other rarely encountered transition metals in biology, including Ti, Cr, and even Nb. The functions of V and these other elements in tunicates are unknown but currently under investigation.

The unit concludes that that the essential metals in biology are relatively more abundant than the nonessential ones. There are several mechanisms by which a cell can take up and concentrate a specific metal ion from its environment. In the dramatic case of vanadium mentioned earlier in this unit, ascidians and tunicates must accumulate the element from sea water, where it exists almost exclusively in the form of  $\text{VO}_4^{3-}$  ion. This negatively charged species enters the cell by means of a specific system known to transport anions, such as sulfate ion, through the outer membrane. Once inside the cell vanadium is reduced, binds to intracellular components, and so can no longer diffuse out into the medium. Many, if not most, metals coordinate to their binding sites in proteins and nucleic acids as simple ions. Thus,  $\text{Zn}^{2+}$  binds to carboxypeptidase and to zinc-finger domains, copper binds plastocyanin as either  $\text{Cu}^+$  or  $\text{Cu}^{2+}$ , and so forth. Sometimes, however, a more complex metal-containing unit is required. Two such examples are described here to show how nature can use inorganic cluster chemistry to achieve specific function in metalloproteins. Although the detailed mechanisms by which these clusters are assembled and inserted into proteins *in vivo* are unknown, it is likely that the process involves spontaneous self-assembly. Apart from the simple metal aqua ions and polymetallic clusters discussed thus far, there are some other specialized metal-binding molecules in biology that deserve mention. These units

differ from ionophores such as enterobactin, which has a single functional purpose. Like the iron-sulfur clusters, they can be inserted into several different metalloproteins and their properties attenuated to meet a particular metabolic need.

---

## 21.7 Review Questions

---

1. Discuss Bioavailability of Metal Ions
2. Define Enrichment Strategies and Intracellular Chemistry of Low-Abundance Metals
3. What is Spontaneous Self-Assembly of Metal Clusters, discuss
4. Give types and details of Specialized Units

---

## 21.8 References

---

1. Principles of Bioinorganic Chemistry- Stephen J. Lippard, ISBN 0935702725, 9780935702729, illustrated Edition, University Science Books, 1994
2. Introduction to Bioinorganic Chemistry - Dieter Rehder University of Lund (2008). Lecture notes.
3. Chemistry- Steven S. Zumdahl , Houghton Mifflin Company Boston New York(2009).

-----

